



**2023**

---

**Rules and Guidance for the Classification of  
High Speed and Light Crafts**

**2023**

Rules for the Classification of

**High Speed and Light Crafts**

---

---

Rules

**2023**

Guidance Relating to the Rules for the Classification of

**High Speed and Light Crafts**

---

---

Guidance



2023

---

Rules and Guidance for the Classification of  
**High Speed and Light Crafts**

**APPLICATION OF  
"RULES FOR THE CLASSIFICATION OF HIGH SPEED  
AND LIGHT CRAFTS"**

1. Unless expressly specified otherwise, the requirements in the Rules apply to Light Craft, or High Speed and Light Craft for which contracts for construction are signed on or after 1 July 2023.
2. The amendments to the rules for 2020 edition and their effective date are as follows:

**Effective Date : 1 July 2023**

---

**Part 3 Hull Structures**

**Chapter 2 Design loads**

**Section 4 Hull Girder Loads**

- 402. has has been amended.

# CONTENTS

<b>PART 1 CLASSIFICATION AND SURVEYS .....</b>	<b>1</b>
<b>CHAPTER 1 CLASSIFICATION .....</b>	<b>3</b>
Section 1 General .....	3
Section 2 Classification Survey during Construction .....	5
Section 3 Classification Survey after Construction .....	5
<b>CHAPTER 2 PERIODICAL AND OTHER SURVEYS .....</b>	<b>7</b>
Section 1 General .....	7
<b>PART 2 MATERIALS AND WELDING .....</b>	<b>9</b>
<b>CHAPTER 1 MATERIALS .....</b>	<b>11</b>
Section 1 General .....	11
<b>CHAPTER 2 WELDING .....</b>	<b>13</b>
Section 1 General .....	13
Section 2 Welding of Aluminium Alloys .....	13
<b>PART 3 HULL STRUCTURES .....</b>	<b>19</b>
<b>CHAPTER 1 DESIGN PRINCIPLES .....</b>	<b>21</b>
Section 1 Definitions .....	21
Section 2 General .....	23
Section 3 Approval of Plans and Documents .....	24
Section 4 Subdivision and Arrangement .....	25
<b>CHAPTER 2 DESIGN LOADS .....</b>	<b>29</b>
Section 1 General .....	29
Section 2 Accelerations .....	29
Section 3 Sea Pressures .....	32
Section 4 Hull Girder Loads .....	39
<b>CHAPTER 3 STRUCTURE PRINCIPLES IN STEEL .....</b>	<b>45</b>
Section 1 General .....	45
Section 2 Materials and Welding .....	48
Section 3 Manufacturing and Inspection .....	49
Section 4 Hull Girder Strength .....	49
Section 5 Platings .....	51
Section 6 Stiffeners .....	57
Section 7 Transverses and Girders .....	62
Section 8 Pillars .....	68
<b>CHAPTER 4 STRUCTURE PRINCIPLES IN ALUMINIUM ALLOY .....</b>	<b>71</b>
Section 1 General .....	71

Section 2	Materials and Welding .....	73
Section 3	Material Protection .....	73
Section 4	Hull Girder Strength .....	74
Section 5	Platings .....	75
Section 6	Stiffeners .....	78
Section 7	Transverses and Girders .....	80
Section 8	Pillars .....	82
<b>CHAPTER 5</b>	<b>STRUCTURE PRINCIPLES IN FRP .....</b>	<b>83</b>
Section 1	General .....	83
Section 2	Materials .....	86
Section 3	Manufacturing .....	87
Section 4	Hull Girder Strength .....	89
Section 5	Sandwich Panels .....	89
Section 6	Single Skin Construction .....	94
Section 7	Transverses and Girders .....	98
<b>PART 4</b>	<b>HULL EQUIPMENT .....</b>	<b>103</b>
<b>CHAPTER 1</b>	<b>RUDDERS .....</b>	<b>105</b>
Section 1	General .....	105
Section 2	Rudder Force .....	106
Section 3	Rudder Torque .....	107
Section 4	Rudder Strength Calculation .....	108
Section 5	Rudder Stocks .....	108
Section 6	Rudder Plates, Rudder Frames and Rudder Main Pieces .....	109
Section 7	Couplings between Rudder Stocks and Main Pieces .....	111
Section 8	Bearings of Rudder Stocks .....	113
Section 9	Rudder Accessories .....	114
<b>CHAPTER 2</b>	<b>HULL APPENDAGES .....</b>	<b>115</b>
Section 1	General .....	115
Section 2	Materials and Workmanship .....	115
Section 3	Arrangement of Appendages .....	116
Section 4	Design Loads and Supporting Structure .....	116
Section 5	Rudder Posts .....	117
Section 6	Shaft Brackets .....	117
Section 7	Foils .....	118
Section 8	Waterjets .....	118
<b>CHAPTER 3</b>	<b>EQUIPMENT NUMBER AND EQUIPMENT .....</b>	<b>119</b>
Section 1	General .....	119
Section 2	Structural Arrangement for Anchoring Equipment .....	120
Section 3	Equipment Number .....	121
Section 4	Anchors .....	122
Section 5	Anchor Chain Cables .....	123
Section 6	Wire Ropes .....	123

<b>CHAPTER 4 HATCHWAYS, WINDOWS AND OTHER OPENINGS .....</b>	<b>127</b>
Section 1 Hatchways and Other Deck Openings .....	127
Section 2 Bulwarks, Freeing Ports, Side Scuttles, Ventilators .....	127
Section 3 Windows .....	129
<b>PART 5 MACHINERY INSTALLATIONS .....</b>	<b>131</b>
<b>CHAPTER 1 GENERAL .....</b>	<b>133</b>
Section 1 General .....	133
<b>CHAPTER 2 AUXILIARIES AND PIPING ARRANGEMENT .....</b>	<b>135</b>
Section 1 General .....	135
Section 2 Bilge and Drainage Systems .....	135
Section 3 Air, Sounding and Filling Pipes .....	136
Section 4 Ship-side Valves and Overboard Discharges .....	137
Section 5 Fuel Oil System .....	138
Section 6 Lubricating Oil System .....	139
Section 7 Cooling Water System .....	139
Section 8 Ventilation Systems .....	139
<b>CHAPTER 3 PRIME MOVERS, POWER TRANSMISSION SYSTEMS AND LIFT DEVICES, ETC. ....</b>	<b>141</b>
Section 1 General .....	141
<b>PART 6 ELECTRICAL EQUIPMENT AND CONTROL SYSTEMS .....</b>	<b>143</b>
<b>CHAPTER 1 ELECTRICAL EQUIPMENT .....</b>	<b>145</b>
Section 1 General .....	145
Section 2 Electrical Equipment .....	145
<b>CHAPTER 2 CONTROL SYSTEMS .....</b>	<b>151</b>
Section 1 General .....	151
Section 2 Automatic and Remote Control Systems .....	151
<b>PART 7 FIRE PROTECTION, DETECTION AND EXTINCTION .....</b>	<b>153</b>
<b>CHAPTER 1 FIRE PROTECTION .....</b>	<b>155</b>
Section 1 General .....	155
Section 2 Structural Fire Protection .....	156
Section 3 Additional Requirements for High Speed Passenger Craft .....	163
Section 4 Additional Requirements for High Speed Cargo Craft .....	163
Section 5 Additional Requirements for Craft and Cargo Spaces intended for the Carriage of Dangerous Goods .....	163
<b>CHAPTER 2 FIRE DETECTION AND EXTINCTION .....</b>	<b>165</b>
Section 1 General .....	165
Section 2 Fire Detection and Extinction .....	165
Section 3 Additional Requirements for High Speed Passenger Craft .....	173

Section 4	Additional Requirements for High Speed Cargo Craft .....	173
Section 5	Additional Requirements for Craft and Cargo Spaces intended for the Carriage of Dangerous Goods .....	173



**PART 1**  
**CLASSIFICATION AND SURVEYS**

## CHAPTER 1 CLASSIFICATION

### Section 1 General

#### 101. Application

1. **Rules for the classification of High Speed and Light Crafts** (hereinafter refer to as "this Rules") are to be applied to the hull structure, constructed in steel, aluminium alloy or fibreglass reinforced plastics (FRP) and other materials which are approved by this Society of the light craft, or high speed and light craft, defined in **103**.
2. In spite of the craft in **Par 1**, cases in which the conditions above are not required, shall be determined at the discretion of this Society.
3. The International Code of Safety for High-Speed Craft, 2000 (hereinafter refer to as "HSC Code"), shall apply to high speed light craft in international operation.
4. Nevertheless regulations of the Rules, crafts constructed in compliance with the related International Conventions are regarded as complying with this Rules. Where the ships have undergone survey according to relevant governmental regulation and allowed to operate within costal area, the application of this requirement may be dispensed with.
5. For the securing of vehicles or cargo of ships which are applied to the Ship's Safety Law of Korea and are engaged on domestic sea voyage, it shall be determined at the discretion of this Society. **[See Guidance]**

#### 102. Classification registry

1. Craft built and surveyed in accordance with the rules of this Society, or with alternative arrangements equivalent to the rules, will be assigned a class in the Register Book.
2. All craft classed with the Society are, for continuation of classification, subject to periodical surveys, and are to be maintained in conditions in accordance with the rule requirements.
3. The requirements, not mentioned in this chapter, are to be in accordance with **Pt 1 of Rules for the Classification of Steel Ships**.

#### 103. Definitions (2020)

The definitions and symbols of terms are as follows.

- (1) **Light craft** means a craft which is complying with a full load displacement of not more than  $(0.13LB)^{1.5}$  (ton).
- (2) **High-speed craft** means a craft which complies with the above mentioned in (1), capable of maximum speed whichever is greater than the followings.
  - (A) 25 (kts)
  - (B)  $7.16 \nabla^{0.1667}$  (kts) or  $3.7 \nabla^{0.1667}$  (m/s)  
( $\nabla$  is in accordance with **Pt 3, Ch 1, 103**.)
- (3) V, L, B and full load displacement ( $D$ ) is as defined in **Pt 3, Ch 1, Sec 1**.
- (4) **Passenger craft** means a craft which carries more than twelve passengers.
- (5) **Cargo craft** means any high-speed craft other than passenger craft, and which is capable of maintaining the main functions and safety systems of unaffected spaces, after damage in any one compartment on board.
- (6) **Cargo spaces** are spaces used for cargo, cargo oil tanks, tanks for other liquid cargo and trunks to such spaces.
- (7) **Datum** means a watertight deck or equivalent structure of a non-watertight deck covered by a weathertight structure of adequate strength to maintain the weathertight integrity and fitted with weathertight closing appliances.
- (8) **Design waterline** means the waterline corresponding to the maximum operational weight of the craft with no lift or propulsion machinery active.

- (9) **Light weight** is the displacement of a ship in tonnes without cargo, fuel, lubricating oil, ballast water, fresh water and feedwater in tanks, consumable stores, and passengers and crew and their effects. The weight of mediums on board for the fixed fire-fighting systems (e.g. fresh-water, CO<sub>2</sub>, dry chemical powder, foam concentrate, etc.) is to be included in the lightweight and lightship condition.
- (10) **Ro-Ro craft** means a craft fitted with one or more ro-ro spaces.
- (11) **Oil fuel unit** is the equipment used for the preparation of oil fuel for delivery to an oil-fired boiler, or equipment used for the preparation for delivery of heated oil to an internal combustion engine, and includes any oil pressure pumps, filters and heaters dealing with oil at a pressure of more than 0.18 MPa.
- (12) **Ro-ro spaces** are spaces not normally subdivided in any way and normally extending to either a substantial length or the entire length of the ship in which motor vehicles with fuel in their tanks for their own propulsion or goods (packaged or in bulk, in or on rail or road cars, vehicles (including road or rail tankers), trailers, containers, pallets, demountable tanks or in or on similar stowage units or other receptacles) can be loaded and unloaded normally in a horizontal direction.  
"Spaces not normally subdivided in any way" means those spaces which are not subdivided in longitudinal direction by watertight bulkheads or gastight bulkheads.
- (13) **Open ro-ro spaces** are those ro-ro spaces that are either open at both ends or have an opening at one end, and are provided with adequate natural ventilation effective over their entire length through permanent openings distributed in the side plating or deckhead or from above, having a total area of at least 10 % of the total area of the space sides.
- (14) **Special category spaces** are those enclosed vehicle spaces above and below the bulkhead deck, into and from which vehicles can be driven and to which passengers have access. Special category spaces may be accommodated on more than one deck provided that the total overall clear height for vehicles does not exceed 10 m.
- (15) **Weather deck** is a deck which is completely exposed to the weather from above and from at least two sides.

#### 104. Class notations

1. The class notations assigned to the craft classed with this Society are to be in accordance with the requirements in **Pt 1, Ch 1, Sec 2 of Rules for the Classification of Steel Ships**.
2. In light craft, the additional notation (LC) shall be appended to the class notation, as defined in previous **Par. 1**.
3. In high speed light craft, the additional notation (HSLC) shall be appended to the class notation, as defined in previous **Par. 1**.
4. In addition to previous **Par. 3**, all light craft and high speed light craft shall be given a service restriction notation, defined in **Pt 3, Ch 1, 121**. (e.g., +KRSOC – Passenger Ship (HSLC – SA2))

## Section 2 Classification Survey during Construction

### 201. Application

Classification Survey During Construction is to be in accordance with the requirements in **Pt 1, Ch 1, Sec 3.** of **Rules for the Classification of Steel Ships.** The craft, constructed in FRP, are also to be in accordance with the requirements in **Ch 2, Sec 2.** of **Rules for the Classification of FRP Ship.**

## Section 3 Classification Survey after Construction

### 301. Application

Classification Survey After Construction is to be in accordance with the requirements in **Pt 1, Ch 1, Sec 4.** of **Rules for the Classification of Steel Ships.** ↴

---

## CHAPTER 2 PERIODICAL AND OTHER SURVEYS

### Section 1 General

#### 101. Application

The Periodical and Other Surveys are to be in accordance with Pt 1, Ch 2. of Rules for the Classification of Steel Ships. ↓

**PART 2**  
**MATERIALS AND WELDING**

---

# CHAPTER 1 MATERIALS

## Section 1 General

### 101. Application

1. The requirements in **Pt 2, Ch 1** of **Rules for the Classification of Steel Ships** are to be applied to steels, aluminium alloys or FRP materials intended to be used for important hull construction of light craft, or high speed and light craft. ↓

---

## CHAPTER 2 WELDING

### Section 1 General

#### 101. Application

1. The requirements for welding of aluminium alloys used for important hull construction of light craft, or high speed and light craft comply with the requirements of this chapter. However, the requirements other than those specified in this chapter are to be in accordance with the related requirements in **Pt 2, Ch 2. of Rules for the Classification of Steel Ships.**
2. The requirements in **Pt 2, Ch 2 of Rules for the Classification of Steel Ships** are to be applied to the welding of steels used for important hull construction of the light craft, or the high speed and light craft.
3. Where deemed appropriate by the Society, National Standards, internationally recognized Codes or Standards considered as equivalent for those may be applied instead of requirements of this Chapter.
4. The welding is to be carried out in accordance with the welding procedures and welding consumables previously approved and by the welders qualified by the Society.

### Section 2 Welding of Aluminium Alloys

#### 201. Groove design

1. The groove design of welded connections, as a rule, is to be in accordance with **Table 2.2.1.** Grooves and root gaps which differ from these may be subject to special consideration.
2. To minimize distortion, the X groove with the narrowest root gap practicable is recommended for thick material, instead of single-V groove.

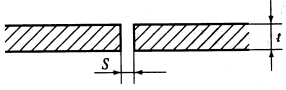
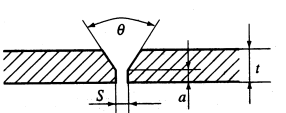
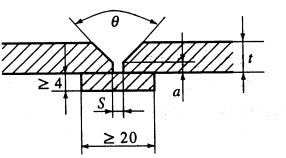
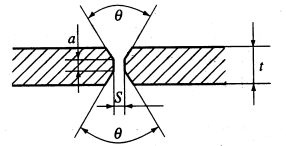
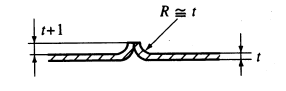
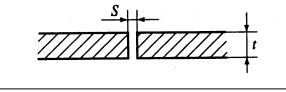
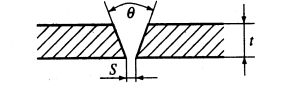

Table 2.2.1 Groove Design of TIG and MIG Welding

	Groove design	Dimension	Remarks
MIG		$t = 1.5 \sim 5$ $s = 0 \sim 2$	Welding from one side. Backing may be used.
		$t = 5 \sim 25$ $s = 0 \sim 3$ $a = 1.5 \sim 3$ $\theta = 60 \sim 100^\circ$	Largest angle is recommended for under-up position. Back chipping and rewelding should be carried out.
		$t = 8 \sim 25$ $s = 3 \sim 7$ $a = 2 \sim 4$ $\theta = 40 \sim 60^\circ$	Smallest joint angle may be used up to 15 mm and with the largest root gap. Position vertical, under-up and side-in require large root gap.
		$t = 12 \sim 25$ $s = 0 \sim 2$ $a = 3 \sim 5$ $\theta = 50 \sim 70^\circ$	Allowed specially for automatic welding. Semiautomatic processes may be used in all positions, and shall be back chipped before welding from backside.
TIG		$t \leq 2$	
		$t \leq 4$ $s = 0 \sim 2$	Welding from one side.
		$t = 4 \sim 10$ $s = 0 \sim 2$ $\theta = 60 \sim 70^\circ$	Backing may be used in horizontal position
$t =$ material thickness (mm) $a =$ root face (mm) $s =$ root gap (mm) $\theta =$ joint angle			

### 202. Welding procedure qualification test

Welding procedures used for welding of aluminium alloys are to have been approved by Society in accordance with the requirements in Pt 2, Ch 2, Sec 4 of Rules for the Classification of Steel Ships.

### 203. Welders

Welders who engage in welding of aluminium alloys are to have been qualified by Society in accordance with the requirements in Pt 2, Ch 2, Sec 5 of Rules for the Classification of Steel Ships.

### 204. Welding consumables

Welding consumables used for aluminium alloys is to be applied in accordance with Table 2.2.2.

**Table 2.2.2 Application of Welding Consumables used for Aluminium Alloy**

Kind and grade of aluminium alloys to be welded		Grade of applicable welding consumables <sup>(1)</sup>
5000 series <sup>(2)</sup>	5754 <i>P</i>	<i>RAIRA, RAIRB, RAIRC</i> <i>RAIWA, RAIWB, RAIWC</i>
	5086 <i>P</i> , 5086 <i>S</i>	<i>RAIRB, RAIRC</i> <i>RAIWB, RAIWC</i>
	5083 <i>P</i> , 5083 <i>S</i>	<i>RAIRC, RAIWC</i>
6000 series <sup>(2)(3)</sup>	6005 <i>AS</i>	<i>RAIRD, RAIWD</i>
	6061 <i>P</i> , 6061 <i>S</i>	<i>RAIRD, RAIWD</i>
	6082 <i>S</i>	<i>RAIRD, RAIWD</i>
(NOTES)		
(1) The symbols used for the materials in this table are same as the symbols specified in <b>Ch 2, Pt 2, 608.</b> of Rules for the Classification of steel ships.		
(2) For welded joint of 5000 series alloys and 6000 series, the welding consumables corresponding to 5000 series alloys specified in this table may be used.		
(3) For welded joint of 6000 series alloys, <i>RAIRA/RAIWA, RAIRB/RAIWB</i> or <i>RAIRC/RAIWC</i> in lieu of <i>RAIRD/RAIWD</i> may be used.		

## 205. Preparation for welding

### 1. Edge preparation

- (1) Proper edge preparation is to be employed.
- (2) Joint edge may be prepared by mechanical cutting, such as band sawing, and by plasma (TIG) arc cutting.

### 2. Cleanliness

- (1) All oil or other hydrocarbons, paint and loose particles from the sawed edges must be removed prior to welding.
- (2) Oil or grease films may be removed chemically by dipping, spraying or wiping the aluminium plate with solvents. Mildly alkaline solutions may be used for cleaning and all welding surfaces shall be thoroughly dried before welding.
- (3) Oxide films, which will prevent fusion between the filler metal and the parent material are to be removed from the weld bevels and a minimum of 75 mm to any side, prior to assembly. Mechanical means, such as a power-driven clean, stainless steel brush, or suitable chemical means are to be used. Welding is to take place immediately after cleaning, and the welding site is to be protected against draft, wind and moisture.

### 3. Backing

- (1) When backing is used, the joint angle is to be large enough to provide accessibility for the root runs.
- (2) Besides aluminium alloys, stainless steel and copper may be used as backing bar material.
- (3) When copper backing is used, copper pickup is to be prevented because local deposition can result in corrosion service.
- (4) Temporary aluminium backing is to be removed by chipping after welding. If the butt weld is not completely fused to the temporary aluminium backing, the root pass is to be back chipped to sound metal after the backing bar has been removed. To ensure adequate penetration, the temporary backing should be grooved.
- (5) When permanent aluminium backing is used, it is necessary to obtain complete fusion between the backing, the root faces and the root layer of the weld. Permanent backing is not recommended where crevice corrosion is of a concern. In these conditions, all edges of the backing bars are to be completely welded.

## 206. Main welding

1. The welding process may be manual, semi-automatic or automatic according to welding procedure specifications.
2. TIG-welding is a recommended process for welding of thinner gages and precision weldments. MIG-welding is recommended for thicker gages.
3. For MIG fillet welds, back stepping is recommended to fully fill the end crater and thereby eliminate cracking problems that usually accompany the crater.
4. Other welding methods such as resistance, spot, seam, stud or electron beam welding may be approved by the Society after consideration in each separate case.

## 207. Preheating

1. Preheating of parts to be welded is to be carried out when the temperature of the parts is below 5 °C or when the mass of the parts is such that the heat is conducted away from the joint faster than the welding process can supply it. Use of preheat is required when welding is performed under high humidity conditions.
2. The preheating temperature must be limited to maximum 60 °C, due to the increased susceptibility of stress corrosion cracking for Al-Mn alloys above this temperature.

## 208. Repair welding

1. Defects in the weld metal or adjacent base material, or both, are to be corrected by complete removal of the defect by chipping or grinding, followed by rewelding according to, in advance, approved welding repair specification.
2. The same filler metal and welding process that was used in the original joint should be employed where possible.

## 209. Quality and inspection of welds

### 1. Penetrant examination

- (1) The surface to be examined with a penetrant is to be clean and free from weld spatter and kept at room temperature at the time of examination. When temperatures range outside of 15 °C to 30 °C, the examination technique at the proposed temperature requires qualification.
- (2) Both colour (red) contrast penetrants and fluorescent penetrants may be used. Optimum penetrating and developing time is required for each process to ensure that every defect will be revealed.
- (3) Sufficient illumination is required to ensure adequate sensitivity during the examination and evaluation of indicators. For red penetrants, good worklight is sufficient, and for fluorescent penetrants the examination is conducted in a darkened area using filtered ultraviolet light (black light).

### 2. Radiographic examination

- (1) The radiography of aluminium welds is normally to be carried out with a conventional x-ray tube. Gamma rays, as emitted from isotopes, should not be used for the radiography of aluminium, except for very heavy sections.
- (2) Radiographic film should be of a medium to fine grain type.
- (3) Al-wire type penetrameters are to be used. The sensitivity level shall be at least 2 %.
- (4) The operator evaluating the film must have a documented minimum of 60 hours training and 12 months practical experience in radiographic testing.

### 3. Ultrasonic examination

- (1) Ultrasonic examination procedures and related matters are left to the discretion of the Society.
- (2) Ultrasonic examination has to be carried out with a higher amplification for aluminium welds because of the danger of lack of fusion.
- (3) Because the sound velocity for aluminium and steel vary slightly, angle probes with small corrections may be used for the sound angle as indicated in **Table 2.2.3**.
- (4) The operator is to be certified in accordance with a recognized certification scheme accepted by

the Society.

Table 2.2.3 Angle of Probes

Steel $\alpha$	Aluminium $\alpha$
35	33
45	42.4
60	55.5
70	63.4

## 210. Acceptance criteria fabrication

### 1. Visual inspection

- (1) All welds are to show good workmanship with smooth transition to the base material without sharp edges. An overlap or deficient weld is not acceptable.
- (2) For butt welds, weld reinforcement or excessive penetration is not to exceed 2 mm.
- (3) For fillet and partial penetration welds, weld reinforcement is not to exceed 3 mm.
- (4) For throat thickness, a negative deviation from that which is specified is not allowed.
- (5) The difference in leg lengths of a fillet weld is not to exceed 3 mm.

### 2. Non-destructive examination

Cracks, incomplete penetration and lack of fusion are not acceptable. ↓

**PART 3**  
**HULL STRUCTURES**

## CHAPTER 1 DESIGN PRINCIPLES

### Section 1 Definitions

#### 101. Application

The definitions of symbols and terms used in this part, except otherwise specified, are to be in accordance with this section. And, the symbols and terms, not defined in this rules, are to be in accordance with **Rules for the Classification of Steel Ships**.

#### 102. Length

The length ( $L$ ) of craft means the overall length of the underwater watertight envelope of the rigid hull, excluding appendages, at or below the design waterline in the displacement mode with no lift or propulsion machinery active.

#### 103. Volume of displacement

Volume of displacement ( $\nabla$ ) means volume of displacement corresponding to the design water line ( $\text{m}^3$ )

#### 104. Breadth

The breadth ( $B$ ) of craft means the breadth of the broadest part of the moulded watertight envelope of the rigid hull, excluding appendages, at or below the design waterline in the displacement mode with no lift or propulsion machinery active.

#### 105. Depth

The depth ( $D$ ) of craft means the vertical distance at the middle of  $L$  measured from the baseline to the top of the freeboard deck beam at side. Where watertight bulkheads extend to a deck above the freeboard deck and are to be registered as effective to that deck,  $D$  is the vertical distance to that bulkhead deck.

#### 106. Load draught

The load draught ( $d$ ) means the vertical distance (m) from the top of keel to the load line measured at the middle of  $L$  with the craft floating at rest in calm water.

#### 107. Full load displacement

The full load displacement ( $\Delta$ ) is the displacement (including shell plating and appendage, etc.) (tons) at the load line.

#### 108. Block coefficient

The block coefficient ( $C_b$ ) is in as the following formula.

$$C_b = \frac{\Delta}{1.025LB_{WL}d}$$

$B_{WL}$  = the breadth of craft at the load line, with the craft at rest. For multihull craft,  $B_{WL}$  is the net sum of the waterline breadths.

#### 109. Maximum speed

The maximum speed ( $V$ ) of craft is the speed achieved at the maximum continuous propulsion power for which the craft is certified at maximum operational weight and in smooth water.

### 110. Freeboard deck

1. The freeboard deck is normally the uppermost continuous deck. However, in cases where openings without permanent means of closing exist on the exposed part of the uppermost continuous deck, or where openings without permanent means of watertight closing exist on the side of the craft below that deck, the freeboard deck is the continuous deck below that deck.
2. In a craft having a discontinuous freeboard deck, the lowest line of the exposed deck, and the continuation of that line parallel to the upper part of the deck, is taken as the freeboard deck.
3. Where the designed load draught is less than the draught determined assuming the existing deck below the freeboard deck is the freeboard deck in accordance with the provision in **Pt 3, Ch 1, 106.**, the existing lower deck is taken as the freeboard deck in the application of the rules. In this case, the lower deck is to be continuous at least between the machinery space and peak bulkheads and continuous athwartships. Where a lower deck is stepped, the lowest line of the deck and continuation of that line parallel to the upper part of the deck is taken as the freeboard deck.

### 111. Superstructure

The superstructure means a decked structure on the freeboard deck, extending from side to side of the craft or having its side walls at the position not farther than  $0.04 B$  from the side of craft. Raised quarter deck is to be considered as a superstructure.

### 112. Deckhouse

The deckhouse means a decked structure above the freeboard deck with the side plating being in-board of the shell plating more than  $0.04 B$  from the side of craft.

long deckhouse : deckhouse having more than  $0.2 L$  of its length within  $0.4 L$  amidship

short deckhouse : deckhouse, not defined as a long deckhouse

### 113. Strength deck

The strength deck means the uppermost continuous deck. A superstructure deck which, within  $0.4 L$  amidship, has a continuous length equal to or greater than  $l_D$  is to be considered as the strength deck instead of the covered part of the uppermost continuous deck.

For twinhull crafts  $l_D = 3(L/15 + H)$  (m)

For monohull crafts  $l_D = 3(B/2 + H)$  (m)

$H$  = height(m) between the uppermost continuous deck and the superstructure deck.

### 114. Bulkhead deck

The bulkhead deck means the highest deck to which the watertight transverse bulkheads except both peak bulkheads extend and are made effective.

### 115. Girder

The girder is a collective term for primary supporting members, usually a supporting stiffener. Other terms used are bottom, side and deck transverse, floor (a bottom transverse), stringer (a horizontal girder), web frame, and vertical web.

### 116. Stiffener

The stiffener is a collective term for secondary supporting members. Other terms used are beam, frame, reverse frame (inner bottom transverse stiffeners) and longitudinal.

### 117. Displacement mode

The displacement mode is the regime, whether at rest or in motion, where the weight of the craft is fully or predominantly supported by hydrostatic forces. Those also mean the states except that the hull is supported by hydrodynamic force for planning crafts and hydrofoil crafts and the hull is supported by air lifting force of pans for hovercrafts.

### 118. Non-displacement mode

The non-displacement mode is the normal operational regime of a craft when non-hydrostatic forces substantially or predominantly support the weight of craft.

### 119. Transitional mode

The transitional mode is the regime between displacement and non-displacement modes.

### 120. Critical design condition

The critical design condition is the limiting specified condition, chosen for design purposes, which the craft should keep in displacement mode. Such condition should be more severe than the worst intended condition by a suitable margin to provide for adequate safety in the survival condition.

### 121. Service area restriction notations

All high speed and light craft are to be given a service area restriction notations of SA followed by a number. Service area restrictions, ranging from SA0 to SA5, given in nautical miles and representing the maximum distance from nearest harbour of safe anchorage, are given in **Table 3.1.1**.

**Table 3.1.1 Service Area Restriction Notation**

Condition Restriction notation	Summer (Nautical miles)	Winter (Nautical miles)	Tropical (Nautical miles)
SA0	Unrestricted	300	Unrestricted
SA1	300	100	300
SA2	100	50	250
SA3	50	20	100
SA4	20	5	20
SA5	2	1	5

NOTE : Seasonal service area restriction is in accordance with ICLL, 1966, Annex II

## Section 2 General

### 201. Application

The requirements in this part are to be applied to light craft, or high speed and light craft constructed in steel, aluminium or fiber composites (FRP) and satisfy relevant requirements given in **Pt 1, Ch 1, 103**.

### 202. Equivalency

1. The requirements, not defined in these rules, are to be in accordance with **Rules for the Classification of Steel Ships**.
2. Alternative hull construction, equipment, arrangement and scantlings are to be accepted by the Society, provided that the Society is satisfied that such construction, equipment, arrangement and scantlings are equivalent to those required in rules.

### 203. Direct strength calculation [See Guidance]

1. Where approved by Society, scantlings of structure members may be determined based upon direct calculation. Where calculated scantlings based on direct calculation exceed the scantlings required in



this part, the former is to be adopted.

2. Where the direct calculation specified in the **Par 1** is carried out, the data necessary for the calculation are to be submitted to the Society.

## Section 3 Approval of Plans and Documents

### 301. Plans and documents for approval

1. In planning the building of a craft which will comply with Classification requirements the following plans and documents are to be submitted for the approval of the Society prior to commencement of the work.
  - (1) Midship section
  - (2) Construction profile
  - (3) Shell expansion
  - (4) Watertight and oiltight bulkheads
  - (5) Deck plans
  - (6) Structure plans of stem, sternframe and rudder
  - (7) Superstructure and deckhouse plans
  - (8) Engine room structure plans
  - (9) Hatchways, hatch covers and coamings arrangements
  - (10) Structure plans of propeller shaft brackets(struts), foils and struts supporting foils
  - (11) Foundations and relevant structure plan of boilers, main engines, thrust bearings, intermediate shaft bearing, generators and other heavy weight auxiliary components
  - (12) Final stability data
  - (13) Other plans and documents specified by the Society
2. When craft are constructed in FRP, the lay-up procedures, joint details, secondary bondings details and materials list are to be submitted along with the approved plans and documents specified in **Par 1** above.

### 302. Plans and documents for reference

1. In planning the building of a craft which will comply with Classification requirements, the following plans and documents for reference are to be submitted in addition to the plans and documents for approval in **301**.
  - (1) General arrangement
  - (2) Specifications
  - (3) Calculation sheets of longitudinal strength
  - (4) Calculation sheets for midship section modulus and scantlings
  - (5) Other plans and documents specified by the Society
2. The final lines, hydrostatic curves, capacity plans, sea trials records and various tests are to be submitted before delivery of the craft.
3. When the craft is constructed in FRP, moulding procedures and certificates of FRP material tests are to be submitted along with the plans and documents referenced in **Par 1** and **Par 2**.

## Section 4 Subdivision and Arrangement

### 401. General

The hull is to be subdivided into watertight compartments as required for the requested service and type notation.

### 402. Transverse watertight bulkheads

1. The following transverse watertight bulkheads are to be fitted in all craft :
  - (1) A collision bulkhead
  - (2) A bulkhead at each end of the machinery space(s)
2. The watertight bulkheads are in general to extend to the freeboard deck. Afterpeak bulkheads may, however, terminate at the first watertight deck above the load line.
3. The watertight bulkheads in way of the raised quarter or sunken forecastle deck is to extend to the side deck.
4. For craft with two continuous decks and a large freeboard to the uppermost deck, the following provisions apply.
  - (1) When the draught is less than the depth of the second deck, only the collision bulkhead need extend to the uppermost continuous deck. The remaining bulkheads may terminate at the second deck.
  - (2) When the draught is greater than the depth to the second deck, the machinery bulkheads, with the exception of the afterpeak bulkhead, are to be watertight to the uppermost continuous deck.
5. In craft with a raised quarter deck, the watertight bulkheads within the quarter deck region are to extend to this deck.

### 403. Collision bulkhead

1. The distance  $X_c$  from the forward perpendicular to the collision bulkhead is to be taken between the limits. However, for the wave piercer, the distance shall be in accordance with Society satisfactions.

$$X_c(\text{minimum}) = 0.05L \text{ (m)}$$

$$X_c(\text{maximum}) = 3.0 + 0.05L \text{ (m)}$$

$L$  = length (m) of the craft

2. Minor steps or recesses in the collision bulkhead are to be accepted, provided the requirements to minimum and maximum distances from the forward perpendicular comply with **Par 1**.
3. For craft having complete or long forward superstructures, the collision bulkhead is to extend to the deck above the freeboard deck. The extension need not be fitted directly over the bulkhead below, provided that the requirements to distances from the forward perpendicular are complied with, and that the part of the freeboard deck forming the step is watertight.

### 404. Openings and closing appliances

1. Openings may be accepted in watertight bulkheads except in that part of the collision bulkhead situated below the freeboard deck.
2. Openings situated below the freeboard deck are to have watertight doors with signboards fitted on each door stipulating that the door be kept closed while the craft is at sea.
3. Openings in collision bulkhead above the freeboard deck are to have watertight doors or an equivalent arrangement. The number of openings in the bulkhead are to be the minimum that are compatible with the craft design and normal operation.
4. Doors in watertight bulkheads are to be complied with the followings :

- (1) Doors may be hinged or sliding.
  - (2) They are to be shown by suitable testing to be capable of maintaining the watertight integrity of the bulkhead.
  - (3) Such testing is to be carried out for both sides of the door and shall apply a pressure head 10 % greater than that determined from the minimum permissible height of a down flooding opening.
  - (4) Testing may be carried out either before or after the door is fitted into the craft but, where shore testing is adopted, satisfactory installation in the craft is to be verified by inspection and hose testing.
5. Type approval may be accepted in lieu of testing individual doors, provided the approval process includes pressure testing to a head equal to, or greater, than the required head (refer to above 4.).
  6. All watertight doors are to be capable of being operated when the craft is inclined up to 15j and fitted with means of indication in the operating compartment showing whether they are open or closed. All such doors are to be capable of being opened and closed locally from each side of the bulkhead.
  7. Watertight doors are to remain closed when the craft is at sea, except that they may be opened for access. A notice shall be attached to each door to the effect that it is not to be left open.
  8. Watertight doors are to be capable of being closed by remote control from the operating compartment in not less than 20 s and not more than 40 s, and are to be provided with an audible alarm, distinct from other alarms in the area, which will sound for at least 5s but no more than 10s before the doors begin to move whenever the door is closed remotely by power, and continue sounding until the door is completely closed.
  9. The power, control and indicators are to be operable in the event of main power failure, as required by **Pt 6** of the Rules. In passenger areas and areas where the ambient noise exceeds 85 dB(A) the audible alarm is to be supplemented by an intermittent visual signal at the door.
  10. If the Administration is satisfied that such doors are essential for the safe work of the craft, hinged watertight doors having only local control may be permitted for areas to which crew only have access, provided they are fitted with remote indicators as required by above mentioned **6**.
  11. Where pipes, scuppers, electric cables, etc. are carried through watertight divisions, the arrangements for creating a watertight penetration are to be of a type which has been prototype tested under hydrostatic pressure equal to or greater than that required to be withstood for the actual location in the craft in which they are to be installed. The test pressure is to be maintained for at least 30 min with 10 % greater than that determined from the minimum permissible height of a downflooding opening and there should be no leakage through the penetration arrangement during this period.
  12. Watertight bulkhead penetrations which are effected by continuous welding do not require prototype testing. Valves on scuppers from weathertight compartments, included in the stability calculations, are to have arrangements for remote closing from the operating station.
  13. Where a ventilation trunk forms part of a watertight boundary, the trunk is to be capable of withstanding the water pressure that may be present taking into account the maximum inclination angle allowable during all stages of flooding.

#### 405. Cofferdams

The installation of cofferdams is to be carried out in accordance with **Pt 3, Ch 15, 304. of Rules for the Classification of Steel ship.**

#### 406. Hydrostatic and watertight tests

In the Classification Survey during Construction, hydrostatic and watertight tests are to be carried out in accordance with **Pt 1, Annex-16 Procedures for Testing Tanks and Tight Boundaries.**

#### 407. Inner bow doors

1. Where ro-ro craft are fitted with a bow loading openings, an inner bow door is to be fitted abaft

such openings, to restrict the extent of flooding in the event of failure of the outer closure. This inner bow door, where fitted, is to be:

- (1) weathertight to the deck above, which deck shall itself be weathertight forward to the bow loading opening;
  - (2) so arranged as to preclude the possibility of a bow loading door causing damage to it in the case of damage to, or detachment of, the bow loading door;
  - (3) forward of all positions on the vehicle deck in which vehicles are intended to be carried; and
  - (4) part of a boundary designed to prevent flooding into the remainder of the craft.
2. A craft is to be exempted from the requirement for such an inner bow door where one of the following applies:
- (1) the vehicle loading deck at the inner bow door position is above the design waterline by a height more than the significant wave height corresponding to the worst intended conditions;
  - (2) it can be demonstrated using model tests or mathematical simulations that when the craft is proceeding at a range of speeds up to the maximum attainable speed in the loaded condition at all headings in long crested seas of the greatest significant wave height corresponding to the worst intended conditions, either:
    - (A) the bow loading door is not reached by waves or having been tested with the bow loading door open to determine the maximum steady state volume of water which accumulates, it can be shown by static analysis that, with the same volume of water on the vehicle deck(s) the residual stability requirements of the HSC Code are satisfied. If the model tests or mathematical simulations are unable to show that the volume of water accumulated reaches a steady state, the craft shall be considered not to have satisfied the conditions of this exemption. Where mathematical simulations are employed they shall already have been verified against full-scale or model testing;
    - (B) bow loading openings lead to open ro-ro spaces provided with guard-rails or having freeing ports complying with the following (C).
    - (C) the deck of the lowest ro-ro space above the design waterline is fitted on each side of the deck with freeing ports evenly distributed along the sides of the compartment. These are either to be proven to be acceptable using tests according to (a) above or comply with the following:
      - (a)  $A \geq 0.3l$   
where :  
 $A$  : the total area of freeing ports on each side of the deck in  $m^2$  ; and  
 $l$  : the length of the compartment in m;
      - (b) the craft is to maintain a residual freeboard to the deck of the ro-ro space of at least 1 m in the worst condition;
      - (c) such freeing ports are to be located within the height of 0.6 m above the deck of the ro-ro space, and the lower edge of the ports shall be within 0.02 m above the deck of the ro-ro space; and
      - (d) such freeing ports are to be fitted with closing devices or flaps to prevent water entering the deck of the ro-ro space whilst allowing water which may accumulate on the deck of the ro-ro space to drain.

#### 408. Other provisions for ro-ro craft

1. All accesses in the ro-ro space that lead to spaces below the deck shall have a lowest point which is not less than the height required from the tests conducted according to **407. 2** (2) or 3 m above the design waterline.
2. Where vehicle ramps are installed to give access to spaces below the deck of the ro-ro space, their openings are to be capable of being closed weathertight to prevent ingress of water below.
3. Accesses in the ro-ro space that lead to spaces below the ro-ro deck and having a lowest point which is less than the height required from the tests conducted according to **407. 2** (2) or 3 m above the design waterline may be permitted provided they are watertight and are closed before the craft leaves the berth on any voyage and remain closed until the craft is at its next berth.
4. The accesses referred to in the above mentioned in **2.** and **3.** are to be fitted with alarm indicators in the operating compartment.

5. Special category spaces and ro-ro spaces are to be patrolled or monitored by effective means, such as television surveillance, so that any movement of vehicles in adverse weather conditions and unauthorised access by passengers thereto can be detected whilst the craft is underway

#### 409. Integrity of superstructure

1. Where entry of water into structures above the datum would significantly influence the stability and buoyancy of the craft, such structures are to be one of the followings:
  - (1) of adequate strength to maintain the weathertight integrity and fitted with weathertight closing appliances; or
  - (2) provided with adequate drainage arrangements; or
  - (3) an equivalent combination of both measures.
2. Weathertight superstructures and deckhouses located above the datum are in the outside boundaries to have means of closing openings with sufficient strength such as to maintain weathertight integrity in all damage conditions where the space in question is not damaged. Furthermore, the means of closing are to be such as to maintain weathertight integrity in all operational conditions.

#### 410. Doors, windows, etc., in boundaries of weathertight spaces

1. Doors, windows, etc., and any associated frames and mullions in weathertight superstructures and deckhouses are to be weathertight and are not to leak or fail at a uniformly applied pressure less than that at which adjacent structure would experience permanent set or fail.
2. For doors in weathertight superstructures, hose tests are to be carried out with a water pressure which is in accordance with **Table 3.1.1** in **Pt 3, Ch 1** of **Rules for the Classification of Steel Ship**.
3. The height above the deck of sills to doorways leading to exposed decks are to be as high above the deck as is reasonable and practicable, particularly those located in exposed positions. Such sill heights are to in general not be less than 100 mm for doors to weathertight spaces on decks above the datum, and 250 mm elsewhere. For craft of 30 m in length and under, sill heights may be reduced to the maximum which is consistent with the safe working of the craft.
4. Windows are not to be permitted in the boundaries of special category spaces or ro-ro spaces or below the datum. If required by restrictions in the Permit to Operate, forward facing windows, or windows which may be submerged at any stage of flooding shall be fitted with hinged or sliding storm shutters ready for immediate use.
5. Side scuttles to spaces below the datum are to be fitted with efficient hinged deadlights arranged inside so that they can be effectively closed and secured watertight.
6. No side scuttle is to be fitted in a position so that its sill is below a line drawn parallel to and one metre above the design waterline.

#### 411. Indicators and surveillance

1. Indicators are to be provided in the operating compartment for all shell doors, loading doors and other closing appliances which, if left open or not properly secured, could lead to major flooding in the intact and damage conditions.
2. The indicator system is to be designed on the fail-safe principle and shall show by visual alarms if the door is not fully closed or if any of the securing arrangements are not in place and fully locked, and by audible alarms if such door or closing appliance becomes open or the securing arrangements become unsecured. The indicator panel in the operating compartment is to be equipped with a mode selection function 'harbour/sea voyage' so arranged that an audible alarm is given in the operating compartment if the craft leaves harbour with the bow doors, inner doors, stern ramp or any other side shell doors not closed or any closing device not in the correct position.
3. The power supply for the indicator systems is to be independent of the power supply for operating and securing the doors.
4. Television surveillance and a water leakage detection system are to be arranged to provide an indication to the operating compartment and to the engine control station of any leakage through inner and outer bow doors, stern doors or any other shell doors which could lead to major flooding. ⚡

## CHAPTER 2 DESIGN LOADS

### Section 1 General

#### 101. General

1. The requirements in this chapter apply to the crafts which comply with **Ch 1, 201**.
2. In cases where crafts are designed according to new concepts to the Society specifications, accelerations or design loads may be modified in consideration of sea conditions and design loads in full scale measurements.
3. The relationship between allowable speed and significant wave height as restricted is to be stated in the Operating Manual and a signboard stating is to be posted in the wheelhouse.
4. Installation of an accelerometer at the longitudinal center of gravity (LCG) may be required.

### Section 2 Accelerations

#### 201. General

1. Accelerations in the craft's vertical, transverse and longitudinal axes are obtained by calculating the corresponding linear acceleration and relevant components of angular accelerations as statistically independent variables. The combined acceleration in each direction is as following formula.

$$a_c = \sqrt{\sum_{m=1}^n a_m^2}$$

$n$  : number of independent variables.

2. In **Par 1** above, transverse or longitudinal component of the angular acceleration is based on the assumption acts simultaneously in the same direction.

#### 202. Design vertical acceleration

1. Design vertical acceleration at the craft's center of gravity  $a_{c.g}$ , is to be specified by the builder, and is normally not to be less than that derived from the formula in **3**.. However,  $a_{c.g}$  is not to be less than  $1.0 g_0$  for SA0 to SA4 and  $a_{c.g}$  is not to be less than  $0.5 g_0$  for SA5. (2018)
- 1-2. For ship with a speed and length ratio ( $V/\sqrt{L} \geq 3.0$ ), the significant wave height shall not be chosen smaller than given in **Table 3.2.1**. for respective ship types. (2018)
2. The design acceleration at different positions along the craft's length is, unless otherwise established, not to be less than :

$$a_v = k_v a_{c.g}$$

$k_v$  : longitudinal distribution factor taken from **Fig 3.2.1**.

**Table 3.2.1** Minimum significant wave height  $H_s$  in m at maximum speed (2018)

Type	$H_s$ (m)
Passenger, Car ferry, Cargo craft	0.25
Patrol boats, naval and naval support vessels	$L < 20 \text{ m} : 0.5$ $L > 30 \text{ m} : 1.5$ $20 \text{ m} \leq L \leq 30 \text{ m} :$ Linear interpolation

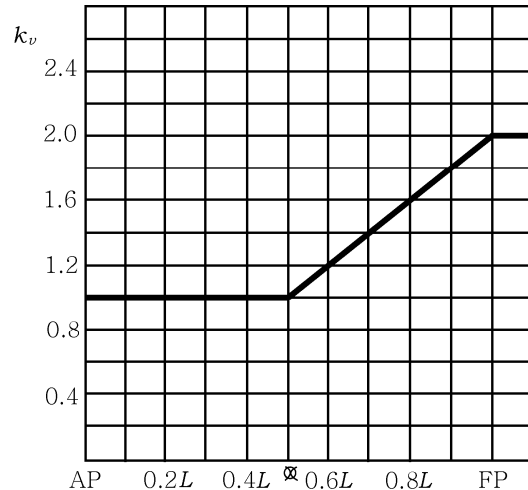

**Fig 3.2.1** Longitudinal Distribution Factor for Vertical Design Acceleration  $k_v$

3. The allowable speed corresponding to the design vertical acceleration  $a_{cg}$  may be estimated from the formulas for the relationship between instantaneous values of  $a_{cg}$ ,  $V$  and  $H_s$  given as :

(1) When  $V/\sqrt{L} \geq 3.0$  :

$$a_{cg} = \frac{k_h g_o}{1650} \left( \frac{H_s}{B_{WL}} + 0.084 \right) (50 - \beta_{cg}) \left( \frac{V}{\sqrt{L}} \right)^2 \frac{L B_{WL}^2}{\Delta} \quad (\text{m/s}^2)$$

$H_s$  : significant wave height (m).

$\beta_{cg}$  : deadrise angle at LCG (maximum 30° minimum 10°).

$B_{WL}$  : waterline breadth at  $L/2$  (m), for multihull craft, the total breadth of each monohull (exclusive of tunnels) is to be used.

$g_o$  : as given in **Par 1**.

$k_h$  : hull type factor taken from **Table 3.2.2**.

But, the design vertical acceleration,  $a_{cg}$  needs not be taken greater than  $6.0 g_o$ .(2018)

(2) When  $V/\sqrt{L} < 3.0$

$$a_{cg} = 6 \frac{H_s}{L} \left( 0.85 + 0.35 \frac{V}{\sqrt{L}} \right) g_o \quad (\text{m/s}^2)$$

4. Unless other values are justified according to accepted theoretical calculations, model tests or full scale measurements, the speed reductions implied by **Par 3** are to be applied. For SWATH and craft with foil assisted hull, accelerations are normally to be determined in accordance with the direct methods above.

5. Relationships between allowable speed and significant wave height are to be stated in the Appendix to Classification Certificate or drawings.

### 203. Horizontal accelerations

1. The longitudinal (surge) acceleration is not to be less than that obtained from the following formula:

$$a_t = 2.5 \frac{C_W}{L} \left( 0.85 + 0.25 \frac{V}{\sqrt{L}} \right)^2 g_o \quad (\text{m/s}^2)$$

$V/\sqrt{L}$  : need not be taken greater than 4.0.

$C_W$  : wave coefficient taken from **Fig 3.2.2**. In cases of craft having unrestricted service area restriction notations, the  $C_W$  is to be determined by the formula below.

Reduction of  $C_W$  for restricted service is taken from **Table 3.2.3**.

0.08 L :  $L \leq 100$  m

6 + 0.02 L :  $L > 100$  m

**Table 3.2.2 Hull Type Factor ( $k_h$ )**

Hull type	$k_h$
Monohull, Catamaran	1.0
Wave piercer	0.9
SES, ACV	0.8
Foil assisted hull	0.7
SWATH	0.7

**Table 3.2.3 Reduction of  $C_W$**

Class notation	Reduction
SA0	0
SA1	
SA2	10 %
SA3	20 %
SA4	40 %
SA5	60 %

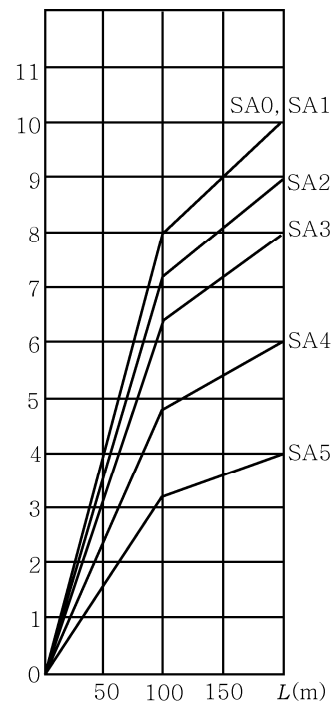

**Fig 3.2.2 Wave Coefficient ( $C_W$ )**

2. Transverse acceleration is not to be less than in the formula below. However, when above the axis of roll, the static component  $g_o \sin \theta_r$  is to be added.

$$a_t = \left( 2 \frac{\pi}{T_R} \right)^2 \theta_r r_r \quad (\text{m/s}^2)$$

$T_R$  : roll period, taken from following formula. However  $V/\sqrt{L}$  need not be taken as greater than 4.0.

$$T_R = \frac{\sqrt{L}}{1.05 + 0.175 \frac{V}{\sqrt{L}}} \quad (\text{s})$$

$\theta_r$  = maximum roll inclination, taken from the following formula:



$$\theta_r = \frac{\pi h_W}{2L} \text{ (rad.)}$$

$h_W$  : maximum wave height in which 70 % of maximum service speed will be maintained, minimum  $0.6 C_W$ .

$r_r$  : height above axis of roll, however, axis of roll is to be taken as given for :

- Axis of roll = waterline (twinhull crafts )
- Axis of roll =  $0.5 D$  (monohull crafts) (2020)

## Section 3 Sea Pressures

### 301. Slamming pressure on bottom

#### 1. Bottom slamming pressure

(1) Slamming pressure on the bottom of craft with speed  $V/\sqrt{L} \geq 3$  is to be as following formula :

$$P_{sl} = 1.3k_l \left( \frac{\Delta}{nA} \right)^{0.3} d_o^{0.7} \frac{50 - \beta_X}{50 - \beta_{cg}} a_{cg} \text{ (kN/m}^2\text{)}$$

$k_l$  : longitudinal distribution factor, taken from **Fig 3.2.3**.

$n$  : Nos. of hull, (Mono hull craft = 1, Twin hull craft = 2)

$A$  : design load area ( $m^2$ ) for element considered, however,  $A$  need not for any structure be taken less than  $0.002(\Delta/d)$ .

(A) plating :  $A$  is not to be taken greater than  $2.5 S^2$

(B) stiffener and girder :  $A = S l$

$S$  : stiffener spacing (m)

$l$  : stiffener or girder span (m)

$d_o$  : draft at  $L/2$  (m) at normal operation condition at service speed.

$\beta_X$  : deadrise angle at transverse section considered. (maximum  $30^\circ$  minimum  $10^\circ$ )

$\beta_{cg}, a_{cg}$  : as given in **202. Par 3**.

(2) The bottom slamming pressure need not be applied to craft with no significant hydrodynamic or air cushion lift in normal operating conditions.

(3) The bottom slamming pressure is to be applied on elements within the area extending from the keel line to chine, upper turn of bilge or pronounced sprayrail.

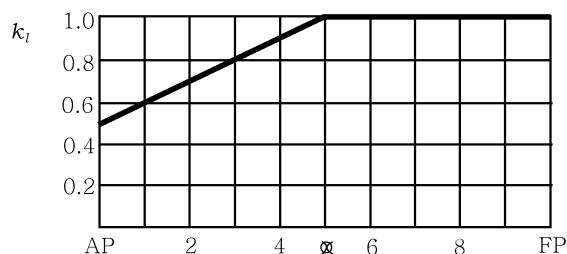

**Fig 3.2.3 Longitudinal Slamming Pressure Distribution Factor ( $k_l$ )**

(4) Deadrise angle,  $\beta_{cg}$  may be estimated according to **Fig.3.2.4**. (2018)

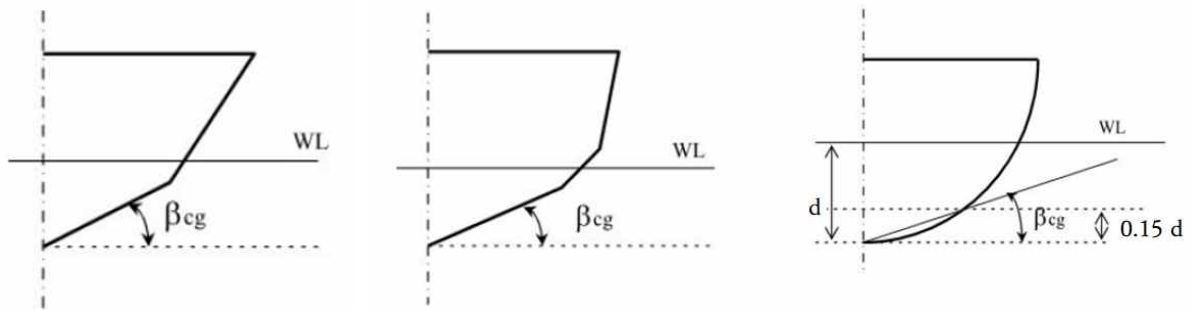

Fig 3.2.4 Deadrise angle,  $\beta_{cg}$

- (5)  $\beta_X$  shall be determined as the angle of the tangent of the hull shell at the centre of the element as shown in Fig 3.2.4-1. (2018)

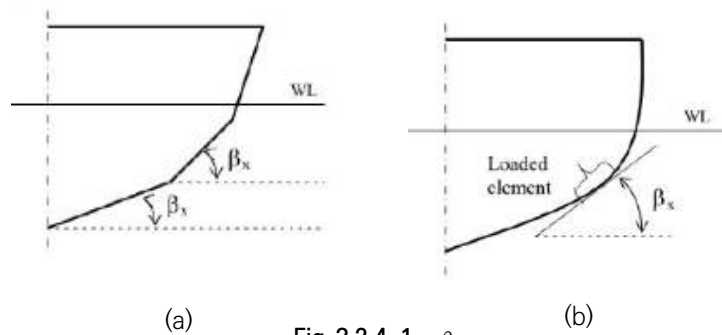

Fig 3.2.4-1  $\beta_X$

## 2. Pitching slamming pressure on bottom

- (1) The pitching slamming pressure on bottom is to be taken following formula.

$$P_{sl} = \frac{21}{\tan(\beta_X)} k_a k_b C_W \left(1 - \frac{20d_L}{L}\right) (0.3/A)^{0.3} \quad (\text{kN/m}^2)$$

$k_a$  : factor taken from belows.

Platings :  $k_a = 1.0$

Stiffeners and girders :  $k_a = 1.1 - 20 \frac{l_A}{L}$

$l_A$  : Longitudinal extend of load area.

$k_{a,max.} = 1.0, k_{a,min} = 0.35$

$k_b$  : factor taken from belows

plates, longitudinal stiffener and girder :  $k_b = 1.0$

Transverse stiffeners and girders :  $k_b = \frac{L}{40l} + 0.5$

$l$  : Span of a stiffener and girder,  $k_{b,max.} = 1.0$

$d_L$  : lowest service speed draught (m) at F.P. measured vertically from waterline to keel line or extended keel line.

$\beta_X$  : as given in 301, Par 1.

$C_W$  : as given in 203, Par 1.

- (2) Above pressure is to extend within a length from FP and within Par 1. (3)

$$l_p = \left(0.1 + 0.15 \frac{V}{\sqrt{L}}\right) L$$

However,  $V/\sqrt{L}$  need not be taken as greater than 3.0,  $l_p$  is to be gradually reduced to zero at  $0.175 L$  aft of the above length.

- (3) Pressure on the bottom structure given in **Par 1** and **Par 2** is not to be less than sea pressure as given in **304**.
- (4) Pitching slamming pressure is to be exposed on elements within the area, extending from the keel line to chine, upper turn of bilge or pronounced sprayrail.

### 302. Forebody side and bow impact pressure

1. Forebody side and bow impact pressure is to be taken as in the following formula. However,  $V/\sqrt{L}$  need not be taken greater than 3.0.

$$P_{sl} = \frac{0.7LC_L C_H}{A^{0.3}} \left[ 0.6 + 0.4 \frac{V}{\sqrt{L}} \sin \gamma \cos(90^\circ - \alpha) + \frac{2.1a_o}{C_B} \sqrt{0.4 \frac{V}{\sqrt{L}} + 0.6 \sin(90^\circ - \alpha)} \left( \frac{x}{L} - 0.4 \right) \right]^2 \quad (\text{kN/m}^2)$$

$A$  : load area for element considered ( $\text{m}^2$ ), however  $A$  is not to be taken greater than  $2.5 S^2 (\text{m}^2)$ . In general,  $A$  need not be taken smaller than  $LB_{WL}/1000$ .

– plates :  $A$  is not to be taken greater than  $2.5 S^2 (\text{m}^2)$

– stiffeners and girders :  $A$  need not be taken smaller than  $e^2 (\text{m}^2)$

$C_H$  : correction factor for length of craft :  $C_H = 1 - \frac{0.5}{C_W} h_o$

$C_W$  may reduced according to **Table 3.2.3**.

$h_o$  : vertical distance in m from waterline at draught  $d$  to the load point.

$e$  : vertical extent of load area, measured along shell perpendicular to the waterline, refer to **Fig 3.2.5. (2019)**.

$x$  : distance (m) from  $AP$  position considered.

$C_L$  : correction factor for length of craft, however,  $L$  not be taken greater than 100 m

$$C_L = \frac{250L - L^2}{15000}$$

$\alpha$  : flare angle taken as the angle between the side plating and a horizontal line, measured at the point considered, refer to **Fig 3.2.6**.

$\gamma$  : angle between the waterline and a longitudinal line at the point considered, refer to **Fig 3.2.7**.

$a_o$  : acceleration factor :  $a_o = 3 \frac{C_W}{L} + C_V \frac{V}{\sqrt{L}}$

$C_V$  : as in the following formula, however, not be taken as greater than 0.2

$$C_V = \frac{\sqrt{L}}{50}$$

$S$  : as given in **301, Par 1**.

$C_W$  : as given in **203, Par 1**.

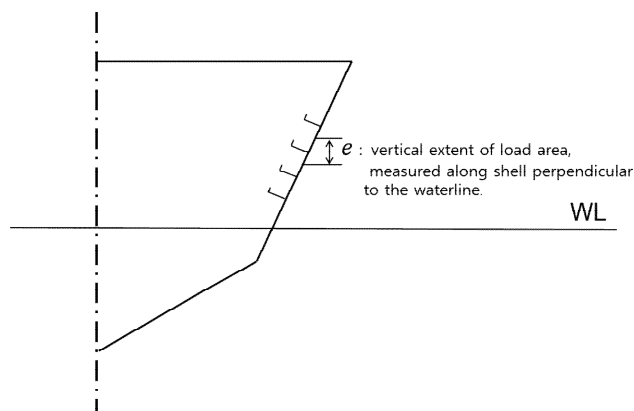

Fig 3.2.5 Vertical extent of load area (2019)

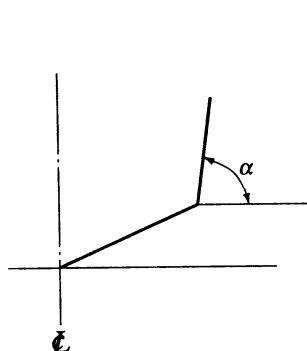

Fig 3.2.6 Angle  $\alpha$

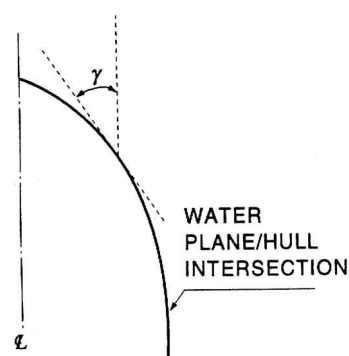

Fig 3.2.7 Angle  $\gamma$

2. Forebody side and bow impact pressure given in 304. shall not be less than the sea pressure.
3. The impact pressure given in Par 1 is to extend a length as follows :
  - (1) The bow and  $0.4 L$  from FP
  - (2) In vertical direction, the impact pressure is to extend from the bottom chine or upper turn of bilge to main deck or vertical part of craft side. The upper turn of bilge is to be taken at a position where the deadrise angle reaches  $70^\circ$  but not higher than the waterline.
  - (3) If no pronounced bottom chine or upper turn of bilge is given (v-shape), the impact pressure is to extend from the keel to main deck or from the vertical part of craft side.

### 303. Slamming pressure on flat cross structures

1. The slamming pressure on flat cross structures (catamaran tunnel top) is to be as following formula :

$$P_{sl} = 2.6k_t \left( \frac{\Delta}{A} \right)^{0.3} a_{cg} \left( 1 - \frac{H_C}{H_L} \right) \quad (\text{kN/m}^2)$$

$A$  : as given in 301. 1.

$H_C$  : minimum vertical distance (m) from WL to load point in operating condition.

$k_t$  : longitudinal pressure distribution factor, refer to Fig 3.2.8.

$H_L$  : necessary vertical clearance (m) from WL to load point to avoid slamming , as following formula.

$$H_L = 0.22 L (k_c - 0.0008 L)$$

$k_c$  : hull type clearance factor, refer to **Table 3.2.4**.

2. Slamming pressure given in **Par 1** is not to be less than sea pressure, as given in **304**.

**Table 3.2.4 Hull Type Clearance Factor ( $k_c$ )**

Hull type	Clearance factor
Catamaran	0.3
Wave piercer	
SES, ACV	
Hydrofoil, foil catamaran	
SWATH	0.5

### 304. Sea pressures

1. Pressure acting on the craft's bottom, side (including superstructure side) and weather decks is to be taken as below formulae :

- (1) For load point below load line :

$$P = 10h_o + \left( k_s - 1.5 \frac{h_o}{d} \right) C_W \quad (\text{kN/m}^2)$$

- (2) For load point above load line. :

$$P = a k_s (C_W - 0.67 h_o) \quad (\text{kN/m}^2)$$

$h_o$  : vertical distance(m) from the load line to the load point.

$k_s$  : longitudinal sea pressure distribution factor, refer to **Fig 3.2.9**.

= 7.5, aft of amidship.

=  $5/C_b$ , forward of FP, between specified areas  $k_s$  shall be varied linearly.

$a$  = 1.0, for craft's sides and open freeboard deck.

= 0.8, for weather decks above freeboard deck.

$C_W$ : as given in **203, Par 1**.

- (3) In no case is the value of sea pressure to be less than the value given in **Table 3.2.5**.

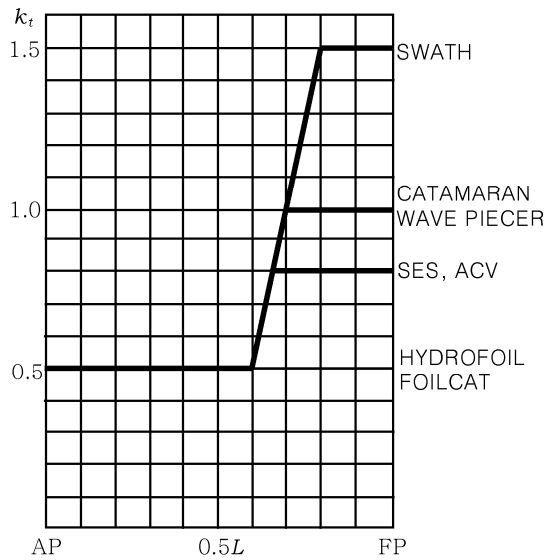

Fig 3.2.8 Flat Cross Structure Slamming Distribution Factor ( $k_t$ )

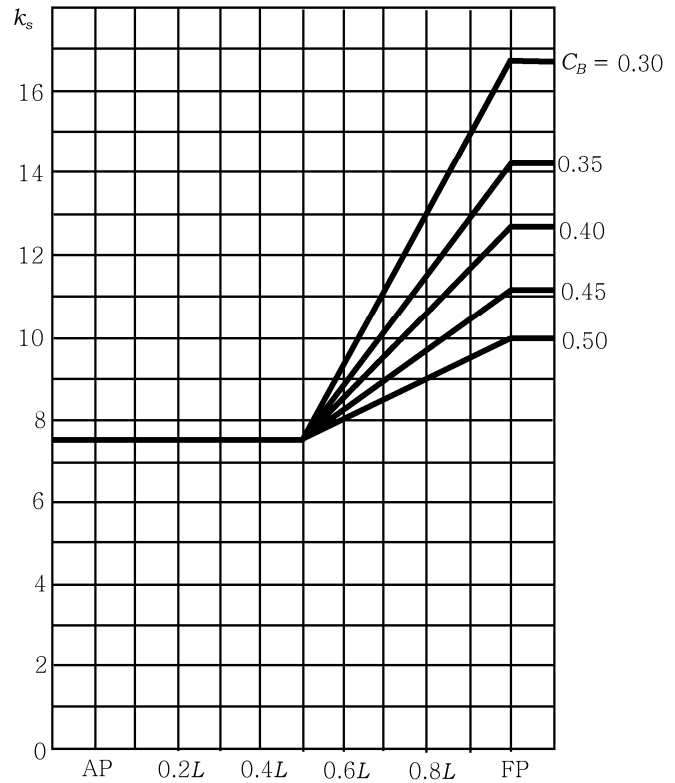

Fig 3.2.9 Sea Load Distribution Factor ( $k_s$ )

Table 3.2.5 Minimum Sea Pressure (kN/m<sup>2</sup>)

Notation	Sides	Weather decks	Roofs higher than 0.1 $L$ above $WL$
SA0, SA1, SA2, SA3	6.5	5	3
SA4	5	4	3
SA5	4	3	3

2. The pressure on superstructure end bulkheads and deckhouses is not to be less than following formulae. However, it should not be less than  $P_{\min}$ .

$$P = a k_s (C_w - 0.67 h_o) \quad (\text{kN/m}^2)$$

- (1) For the lowest tier of unprotected front :  $P_{\min} = 5 + (5 + 0.05 L) \sin \alpha$  (kN/m<sup>2</sup>)

- (2) Elsewhere :

$$P_{\min} = 5 + 0.025 L \sin \alpha \quad (\text{kN/m}^2)$$

$\alpha$  : the angle between the bulkhead and deck.

$a = 2.0$ , for lowest tier of unprotected front.

$a = 1.5$ , for deckhouse fronts.

- = 1.0, for deckhouse sides.
- = 0.8, elsewhere.

3. The pressure on watertight bulkheads (compartment flooded) is to be taken less than as following formula :

$$P = 10 h_b \text{ (kN/m}^2\text{)}$$

$h_b$  : vertical distance (m) from the load point to the top of bulkhead or to the flooded waterline, if deeper

### 305. Liquids

1. The pressure in deep tanks is to be taken as the greater of the following formulae.

$$P_1 = \rho(g_o + 0.5a_v) h_s \text{ (kN/m}^2\text{)}$$

$$P_2 = 0.67 \rho g_o h_p \text{ (kN/m}^2\text{)}$$

$$P_3 = \rho g_o h_s + 10 \text{ (kN/m}^2\text{)}, \text{ for } L \leq 50 \text{ m}$$

$$P_3 = \rho g_o h_s + 0.3L - 5 \text{ (kN/m}^2\text{)}, \text{ for } L > 50 \text{ m}$$

$a_v$  : as given in **202, Par 2.**

$h_s$  : vertical distance (m) from the load point to the top of tank

$h_p$  : vertical distance (m) from the load point to the top of air pipe or filling station

$\rho$  : density of liquid (t/m<sup>3</sup>), however not to be taken as less than 1.025

2. The pressure on wash bulkheads is to be as following formula :

$$P = 3.5l_t \text{ (kN/m}^2\text{)}$$

$l_t$  : the greater distance (m) to the next bulkhead forward or aft

### 306. Dry cargo, stores and equipment

1. The pressure on inner bottom, decks or hatch covers is to be taken as following formula :

$$P = \rho H(g_o + 0.5a_v) \text{ (kN/m}^2\text{)}$$

$a_v$  : as given in **202, Par. 2.**

$H$  : stowage height (m)

$\rho$  : density of cargo (t/m<sup>3</sup>)

2. Standard values of  $\rho H$  are given in **Table 3.2.6**

Table 3.2.6 Standard Load Parameters

Decks	Parameters (kN · m)
Weather deck and weather deck hatch covers for cargo	$\rho H = 1.0 \text{ t/m}^2$
Sheltered deck, Sheltered hatch covers and inner bottom for cargo	$\rho = 0.7 \text{ t/m}^2$ $H$ : Vertical distance from the load point to the deck above. For load points below hatchways, $H$ is to be measured to the top of coaming
Platform deck in machinery space (s)	$\rho H = 1.6 \text{ t/m}^2$
Accommodation decks	$\rho H = 0.35 \text{ t/m}^2$

### 307. Heavy units

The vertical force acting on supporting structures from rigid units of cargo, equipment or other structural components is to be as following formula :

$$P = (g_o + 0.5a_v) M \quad (\text{kN})$$

$a_v$  : as given in **202, Par 2**

$M$  : mass of unit (t)

## Section 4 Hull Girder Loads

### 401. Longitudinal bending, shearing and axial loads

#### 1. General

- (1) For craft of ordinary hull form with  $L/D$  less than 12, with length less than 50 m, the minimum strength standard is normally satisfied for scantlings obtained from local strength requirements.
- (2) For other types of craft, with  $L/D$  greater than 12, and for craft with length greater than 50 m, the longitudinal strength is to be calculated as described below.

#### 2. Bending moment from slamming pressure

- (1) For craft  $V/\sqrt{L} \geq 3.0$ , a slamming pressure is acting on an area equal to the reference area,  $A_R$ :

$$A_R = k \Delta \frac{\left(1 + 0.2 \frac{a_{cg}}{g_o}\right)}{d} \quad (\text{m}^2)$$

$g_o, a_{cg}$  : as given in **202, Par 2**

$k = 0.7$  for crest landing

0.6 for hollow landing

- (2) Crest landing moment

(A) The load combination illustrated in **Fig 3.2.10** is to be required with actual weight distribution along the hull beam. The longitudinal midship bending moment is to be as below. However,  $(e_w - 0.25l_s)$  is not to be taken as less than  $0.04 L$ .

$$M_B = \frac{\Delta}{2} (g_o + a_{cg}) (e_w - 0.25l_s) \quad (\text{kN} \cdot \text{m})$$



$g_o, a_{cg}$  : as given in **202, Par 2**.

$e_w$  : one half of the distance (m) from LCG of the fore half body to the LCG of aft half body of the craft. If not known,  $e_w = 0.25 L$  ( $0.2 L$  for hollow landing).

$l_s$  : longitudinal extension of slamming reference area as :

$$l_s = \frac{A_R}{b_s}$$

$b_s$  : breadth of the slamming reference area, refer to **Fig 3.2.12**.

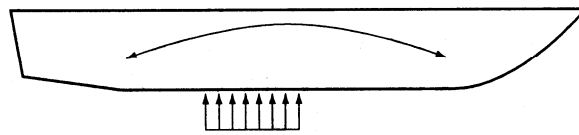

**Fig 3.2.10 Crest Landing**

(B) The reduction of  $M_B$  towards ends will be determined by weight distribution and the extent of  $A_R$ .

(3) Hollow landing moment

Hollow landing is similar to crest landing except that the reference area  $A_R$  is situated towards AP and FP, refer to **Fig 3.2.11**. However,  $(e_r - e_w)$  is not to be taken as less than  $0.04 L$ . The longitudinal midship bending moment is to be as following formula :

$$M_B = \frac{\Delta}{2} (g_o + a_{cg}) (e_r - e_w) \quad (\text{kN} \cdot \text{m})$$

$g_o, a_{cg}$  : as given in **202, Par 2**.

$e_r$  : mean distance (m) from the center of  $A_R/2$  end areas to craft LCG

$e_w$  : as given in preceding (2)

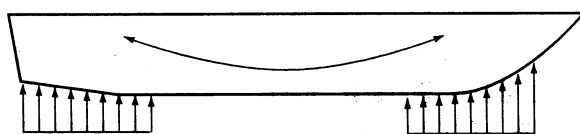

**Fig 3.2.11 Hollow Landing**

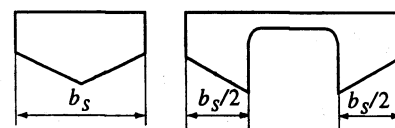

**Fig 3.2.12 Breadth of Midship Slamming Reference Area**

**3. Planning moment of hydrofoils**

Hydrofoils longitudinal strength is to be calculated for the most severe conditions. As a rule, this will consider the craft as sustained above the water surface by the foils, and stationary in the navigation condition, taking into account vertical acceleration as well as vertical components of the hydrodynamic action of the water on the foils.

**4. Hogging and sagging bending moments**

Investigation of sagging and hogging bending moment (still water + wave), taking into account any immersed/emerged structures, may be required for all craft.

(1) Monohull craft

$$M_{hog} = M_{sw} + 0.19 C_W L^2 B C_b \quad (\text{kN} \cdot \text{m})$$

$$M_{sag} = M_{sw} + 0.14 C_W L^2 B (C_b + 0.7) \quad (\text{kN} \cdot \text{m})$$

$C_W$  : as given in **203, Par 1.**

$M_{sw}$  : still water bending moment in the most unfavourable loading condition ( $\text{kN} \cdot \text{m}$ )<sup>1)</sup>

if hogging is not known =  $0.11 C_W L^2 B C_b$  ( $\text{kN} \cdot \text{m}$ )

if sagging is not known =  $0$ <sup>2)</sup>

NOTES :

- 1) Documentation of the most unfavourable still water condition is normally to be submitted for information.
- 2) If still water bending moment is hogging moment, 50 % of this moment may be deducted where the design sagging moment ( $M_{sag}$ ) is calculated.

(2) Twin hull craft

$$M_{hog} = M_{sw} + 0.19 C_W L^2 (B_{WL} + k_2 B_{tn}) C_b \quad (\text{kN} \cdot \text{m})$$

$$M_{sag} = M_{sw} + 0.14 C_W L^2 (B_{WL} + k_3 B_{tn}) (C_b + 0.7) \quad (\text{kN} \cdot \text{m})$$

$M_{sw}$  : still water bending moment in the most unfavourable loading condition ( $\text{kN} \cdot \text{m}$ )<sup>1)</sup>

if hogging is not known =  $0.5 \Delta L$  ( $\text{kN} \cdot \text{m}$ )

if sagging is not known =  $0$ <sup>2)</sup>

NOTES :

- 1) Documentation of the most unfavourable still water condition is normally to be submitted for information.
- 2) If still water bending moment is hogging moment, 50 % of this moment may be deducted where the design sagging moment ( $M_{sag}$ ) is calculated.

$B_{tn}$  : breadth of cross structure (m).

$k_2$  and  $k_3$  : factors for the effect of cross structure immersion in hogging and sagging wave as below. however, not to be taken as less than 0.0

$$k_2 = 1 - \frac{z - 0.5d}{0.5d + 2C_W}$$

$$k_3 = 1 - \frac{z - 0.5d}{0.5d + 2.5C_W}$$

$z$  : height (m) from base line to wet deck (top of the tunnel)

## 5. Shear forces from longitudinal bending

Shear forces of vertical hull girder is to be as following formula :

$$Q_b = \frac{M_B}{0.25L} \quad (\text{kN})$$

$M_B$ : bending moment ( $\text{kN} \cdot \text{m}$ ) as given in preceding **Par 2.** (2) and (3).

## 6. Axial loads

Axial loads ( $Surge = \Delta \cdot a_i$ ), thrust and sea end pressure are to be considered in exposed areas.

$a_i$  : maximum surge acceleration is not to be less than following formulas

$$0.4 g_o, \frac{V}{\sqrt{L}} \geq 5$$

$$0.2 g_o, \frac{V}{\sqrt{L}} \leq 3$$

with linear interpolation for intermediate  $V/\sqrt{L}$

## 402. Twin hull loads

### 1. General

- (1) The transverse strength of the twinhull connecting structure is to be analysed for moments and forces as specified below.
- (2) Design forces and moments are to be used unless other values are verified by model tests or full scale measurements, or if similar structures provided are satisfactory in service.
- (3) Superstructure is normally not to be included in the structure for transverse strength.

### 2. Transverse bending moment and shear force

- (1) For the twinhull transverse bending moment of craft with  $V/\sqrt{L} \geq 3.0$  and  $L < 50$  m, refer to Fig 3.2.13, is to be as following formula :

$$M_S = \frac{\Delta a_{cg} b}{s} \quad (\text{kN} \cdot \text{m})$$

$b$  : transverse distance (m) between the centerlines of the two hulls.

$s$  : factor given in Table 3.2.7.

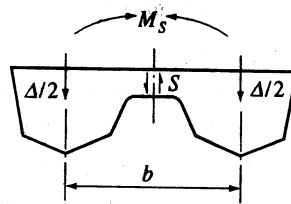

Fig 3.2.13 Transverse Vertical Bending Moment and Shear Force

- (2) For craft with  $L \geq 50$  m, the twinhull transverse bending moment is to be the greater of following formula.  $B_{WL}$  can here be taken as the waterline breadth at  $L/2$  and  $V/\sqrt{L}$  needs not to be taken greater than 3. (2023)

$$M_S = M_{SO} (1 + a_{cg}/g_o) \quad (\text{kN} \cdot \text{m})$$

$$M_S = M_{SO} + F_y (z - 0.5d) \quad (\text{kN} \cdot \text{m})$$

$M_{SO}$  : transverse bending moment in still water (kN · m) **【See Guidance】**

$F_y$  : horizontal split force on immersed hull, as following formula.

$$F_y = 3.25 \left( 1 + 0.0172 \frac{V}{\sqrt{L}} \right) L^{1.05} d^{1.3} (0.5 B_{WL})^{0.146} \left( 1 - \frac{L_{BMAX}}{L} + \frac{L_{BMAX}}{L} \left( \frac{B_{MAX}}{B_{WL}} \right)^{2.1} \right) H_1 \quad (\text{kN})$$

- $H_1$  = minimum of  $0.143B$  and  $H_{(S, MAX)}$   
 $B_{WL}$  = maximum width (m) in water line (sum of both hulls)  
 $B_{MAX}$  = maximum width (m) of submerged part (sum of both hulls)  
 $L_{BMAX}$  = length in metres where  $B_{MAX}/B_{WL} > 1$   
 $H_{(S, MAX)}$  = maximum significant wave height in which the vessel is allowed to operate (m)  
 $B$  = beam over all (m)  
 $z$  : height from base line to neutral axis of cross structure (m).  
 $\frac{V}{\sqrt{L}}$  need not to be taken greater than 3.

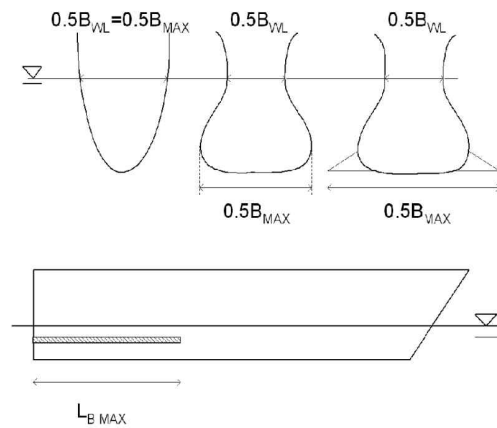

Definition of parameters in case of different sectional shapes

(3) The vertical shear force in centerline between twinhull is to be as following formula :

$$S = \frac{\Delta a_{cg}}{q} \quad (\text{kN})$$

$q$  : factor given in **Table 3.2.7**

### 3. Pitch connecting moment

The twinhull pitch connecting moment is, refer to **Fig 3.2.14** to be as following formula :

$$M_p = \frac{\Delta a_{cg} L}{8} \quad (\text{kN} \cdot \text{m})$$

Table 3.2.7 Factors  $s$  and  $q$

Service restriction	$s$	$q$
SA4	8.0	6.0
SA3	7.5	5.5
SA2	6.5	5.0
SA1	5.5	4.0
SA0	4.0	3.0

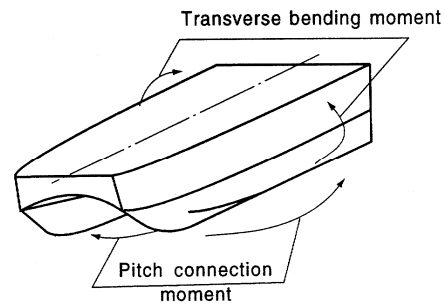

Fig 3.2.14 Pitch Connecting Moment on Twinhull Connection

#### 4. Twinhull torsional moment

The twinhull torsional moment is to be as following formula

$$M_t = \frac{\Delta a_{cg} b}{4} \quad (\text{kN} \cdot \text{m})$$

$b$  : as given in Par 2  $\Downarrow$

## CHAPTER 3 STRUCTURE PRINCIPLES IN STEEL

### Section 1 General

#### 101. Application

1. Hull structures, constructed in materials complying with the requirements in **Sec 2**, are to be comply with requirements in this chapter.
2. Requirements, not included in this chapter, are to be in accordance with those in **Rules for the Classification of Steel Ships**.

#### 102. The scantling reduction

Scantling reductions for high speed and light craft structures, when compared with ordinary steel ship rules, are based on the following :

- (1) Thorough corrosion protection of steel
- (2) A stiffener spacing reduction ratio ( $S/S_r$ )

$$S_r = 0.002(240 + L) \text{ (m), deep tank bulkheads} \\ = 0.76 \text{ (m), other bulkheads}$$

- (3) Longitudinal framing in bottom and strength deck
- (4) Extended longitudinal and local buckling control
- (5) Sea and weather service restriction

#### 103. Bottom, side and deck structures

This chapter applies to single skin structures. Based on the changes in total stress pattern, it may also apply to double bottom and other cofferdam type structure adjustments.

#### 104. Flat cross structure

1. A flat cross structure is a horizontal structure above the waterline, such as the bridge connecting structure between twinhulls.
2. A flat cross structure is normally to be longitudinally stiffened.
3. The stiffening of the central part of the upper deck is to result in achieving necessary transverse buckling strength.

#### 105. Bulkhead structures

##### 1. Transverse bulkheads

- (1) The number and location of transverse watertight bulkheads is to be in accordance with the requirements given in **Ch 1, 402**.
- (2) The stiffening of the upper part of a plane transverse bulkhead is to be such that the necessary transverse buckling strength is achieved.

##### 2. Corrugated bulkheads

- (1) The spacing of corrugated bulkheads is defined according to **Fig 3.3.1**.

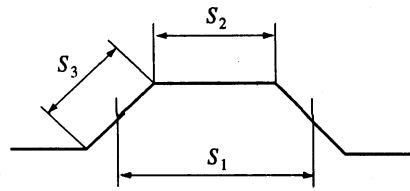

Fig 3.3.1 Corrugated Bulkheads

- $S = S_1$ , spacing for section modulus calculation
- $= 1.05S_2$  or  $1.05S_3$ , spacing for plate thickness calculations in general
- $= S_2$  or  $S_3$ , spacing for thickness calculation when 90 degrees corrugations

- (2) Section modulus and thickness formulas for corrugated bulkheads are same as that of plane bulkheads.
- (3) Thickness of corrugated bulkheads
  - (A) Unless the buckling strength is proven satisfactory by direct stress calculations, the following additional requirements apply to corrugated bulkheads.

$$t = \frac{S_2}{50} : \frac{S_2}{S_3} = 0.5$$

$$t = \frac{S_2}{70} : \frac{S_2}{S_3} \geq 1.0$$

Intermediate values are obtained by interpolation.

- (B) For a corrugated bulkhead with a section modulus greater than that required, the required thickness may be multiplied by according to the value.

$$\sqrt{\frac{Z_{rule}}{Z_{act}}}$$

$Z_{rule}$  : required section modulus

### 106. Supporting bulkheads

When bulkheads supporting decks are to be considered as pillars, the compressive load and buckling strength are to be considered.

### 107. Definition of span ( $l$ )

Effective span ( $l$ ) of stiffener, girder or transverse depends on the design of the end connection as shown on Fig 3.3.2.

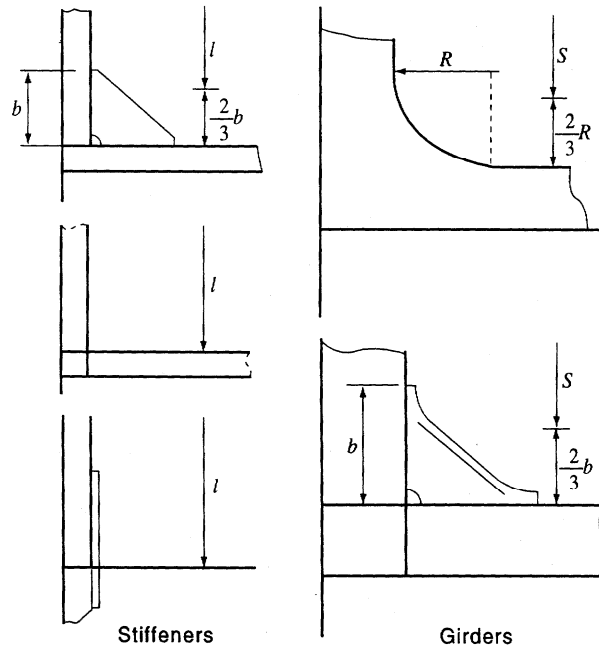

Fig 3.3.2 Definition of Span ( $l$ )

### 108. Load point

The load point for which the design pressure in **Ch 2** is defined for various strength members is as follows.

- (1) Horizontally stiffened platings  
Mid point of horizontally stiffened plating.
- (2) Vertically stiffened platings  
Half of the stiffener spacing above the lower support of vertically stiffened plating, or at the lower edge of plating when the thickness is changed within the plating.
- (3) Stiffeners  
Mid point of span.
- (4) Transverse or girders  
Mid point of load area.

### 109. Buckling strength calculation

The buckling strength calculation is to be in accordance with **Pt 3, Ch 3, Sec 4.** of **Rules for the Classification of Steel Ships.**



## Section 2 Materials and Welding

### 201. Materials

1. The materials used for hull construction and equipment are to comply with the requirements in **Pt 2, Ch 1, of Rules for the Classification of Steel Ships**, unless other specified.
2. Where materials other than those specified in rules are used, their use and the corresponding scantlings are to be specially approved by the Society.
3. Where high tensile steels are used for hull construction, the drawings showing their scope and location together with their type and scantlings, must have Society approval.
4. Steel used for hull construction is to comply with the requirements in **Pt 3, Ch 1, Sec 4. of Rules for the Classification of Steel Ships**.

### 202. Welding

1. Welding is to be in accordance with **Pt 2, Ch 2**.
2. Welding structures are to be in accordance with **Pt 3, Ch 1, Sec 5. of Rules for the Classification of Steel Ships**.

### 203. Corrosion protection

1. All steel surfaces, except in oil tanks for craft use, are to be protected against corrosion by suitable paint or other effective coating. Inner bottoms and decks for dry cargoes shall be specially considered.
2. For other materials, such as propellers, provisions are to be made to avoid galvanic corrosion.
3. Coating specifications, including antifouling, are to state details concerning :
  - (1) Metal surface cleaning and treatment before application of primer coat.
  - (2) The system for build-up of coating with individual coats.
  - (3) Curing time and overcoating intervals.
  - (4) Acceptable temperatures of air and metal surfaces.
  - (5) Acceptable dryness/humidity conditions during above operations.
  - (6) Thickness of individual and final coatings.

#### 4. Coatings

- (1) Before coating, the metal surface is to be properly treated by blast cleaning.
- (2) Shop primer applied over areas which will subsequently be welded, shall have no detrimental effect on the finished welds.
- (3) Coatings are to be compatible with previously applied shop primer. Primer or intermediate coating which have been exposed for some time must be cleaned before application of the next coat.

#### 5. Provisions to avoid galvanic corrosion

- (1) Acceptable provisions are either one of or a combinations of the following.
  - (A) Coating of exposed surfaces by moisture.
  - (B) Electrical insulation of different metals.
  - (C) Cathodic protection.
- (2) In addition to the coating, external cathodic protection of steel hulls can be obtained with aluminium or zinc sacrificial anodes or impressed current.
- (3) If an impressed current system is applied, precautions must be taken to avoid overprotection by means of anode screen and overprotection alarm.

#### 6. Specification and documents of cathodic protection

- (1) Specifications of cathodic protection systems are to state details as follows.
  - (A) Areas to be protected.
  - (B) Current density demand.
  - (C) Anode material and manufacturer.

- (D) Anode weight, distribution and total number.
- (E) Service life of anode.
- (2) The designed service life of the cathodic protection system is normally to be for at least 5 years.

#### 7. Deck composition

Deck composition is subject to type approval. It is to be of an elastic, non-hygroscopic material. Deck compositions for application in cargo areas are to be suitably reinforced.

## Section 3 Manufacturing and Inspection

### 301. Construction

1. Welding of structures, machinery installation and equipment is to be carried out by approved welders, with approved welding consumables.
2. The welding ambient temperature is higher than  $-5\text{ }^{\circ}\text{C}$

### 302. Inspection

1. The welding is to be examined by X-ray or by other approved methods in positions indicated by the surveyor.
2. All weld crossings in the bottom and deck plating, within  $0.4 L$  amidships, are to be examined.

### 303. Testing

1. All pipe connections to tanks are to be fitted before testing. Protective coating is normally not to be carried out before the tank test.
2. All watertight/weathertight doors and hatches are to be function tested.
3. Hydrostatic and watertight tests are to be in accordance with **Pt 3, Ch 1, 209.** of **Rules for the Classification of Steel Ships.**

## Section 4 Hull Girder Strength

### 401. General

1. Requirements for longitudinal and transverse hull girder strength are given in this section. In addition, buckling control may be required.
2. For the craft types and sizes mentioned in **Ch 2, Sec 4**, longitudinal strength has to be checked.
3. For large, complicated crafts, such as multihull types, a complete, 3-dimensional global analysis of the transverse strength, in combination with longitudinal stress, is to be carried out.
4. Buckling strength in the bottom and deck is to be inspected.

### 402. Deck corners

Moulded deck line, rounded sheer strake, sheer strake and stringer plate are defined in **Fig 3.3.3.**

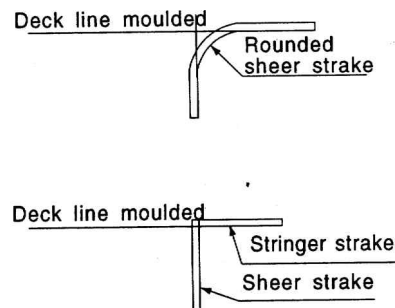

Fig 3.3.3 Deck Corners

#### 403. Vertical bending strength

As defined, hull section modulus ( $Z_R$ ) in midship, is to be greater than as following formula :

$$Z_R = \frac{M}{\sigma} \times 10^3 \quad (\text{cm}^3)$$

$M$  : longitudinal midship bending moment ( $\text{kN} \cdot \text{m}$ )

=  $M_B$  as defined in **Ch 2, 401, Par 2**, monohull, catamaran and SES in crest and hollow landing.

=  $M_B$  as defined in **Ch 2, 401, Par 3**, hydrofoil on foils.

=  $M_B$  as defined in **Ch 2, 401, Par 4**, hydrofoil in slowed down condition, ACV, high-speed displacement craft and semi-planning craft in displacement mode.

$\sigma$  : allowable bending stress as follows.

=  $175/K$  ( $\text{N}/\text{mm}^2$ ), in general

=  $160/K$  ( $\text{N}/\text{mm}^2$ ), hydrofoil on foils

=  $140/K$  ( $\text{N}/\text{mm}^2$ ), planning craft in slowed-down condition

$K$  : as defined in **501. Par 3**.

#### 404. Effective section modulus

The calculation of section modulus is to be in accordance with **Pt 3, Ch 3, 203.** of **Rules for the Classification of Steel Ships**.

#### 405. Shear strength

1. If doors are arranged in the craft side, the required sectional area of the remaining side plating will be specially considered.
2. If rows of windows are arranged below the strength deck, sufficient horizontal shear area must be arranged to carry down the midship tension and compression.
3. In these and other locations with doubtful shear areas, may be taken according to the following formula.

$$\tau_P = \frac{\sigma}{\sqrt{3}} \quad (\text{N}/\text{mm}^2)$$

#### 406. Transverse strength of twin hull craft

##### 1. Transverse strength

- (1) The twinhull connecting structure is to have adequate transverse strength related to the design loads and moments in **Ch 2**.

- (2) When calculating the moment of inertia and section modulus of the longitudinal section of the connecting structure, the effective sectional area of transverse strength members is in general the net area with effective flange after deduction of the openings. The effective shear area of transverse strength members is in general the net area after deduction of the openings.

## 2. Allowable stresses

When calculating the strength of twinhulls, applied in loads, and defined in **Ch 2, 402**, the allowable stress are to be followed.

(1) Normal stress :  $\sigma = 160/K$  (N/mm<sup>2</sup>)

(2) Mean shear stress :  $\tau = 90/K$  (N/mm<sup>2</sup>)

(3) Equivalent stress :  $\sigma_e = 180/K$  (N/mm<sup>2</sup>)

Equivalent stress is defined as following formula :

$$\sigma_e = \sqrt{\sigma_x^2 + \sigma_y^2 - \sigma_x \sigma_y + 3\tau^2}$$

$\sigma_x$  : total normal stress in x-direction.

$\sigma_y$  : total normal stress in y-direction.

$\tau$  : total shear stress in xy-plane.

Total stress means the arithmetic sum of stresses from hull girder, local forces and moments.

$K$  : as defined in **501. Par 3**.

## 407. Buckling strength

The strength deck or side plating is to be endured the buckling strength subject to hull girder bending stress.

# Section 5 Platings

## 501. Definitions

1. Craft side is ranged as defined below :

(1) Upper bound : the upper deck, including long and short superstructure sides.

(2) Lower bound : the top of the bottom structure.

(3) Forward bound : the stem.

(4) Aft bound : the stern including transom.

2. The upper bound of the slamming area is at the turn of bilge or chine knuckles, and in cases no knuckles case, the upper bound shall be reached at 1.25  $d$ (m) above keel.

3. The definitions of symbols used in this chapter, unless specified otherwise, are to be in accordance with the following :

$t$  : thickness of plating (mm)

$Z$  : section modulus of stiffeners (cm<sup>3</sup>)

$S$  : stiffener spacing measured along the plating (m)

$S_r$  : basic stiffener spacing (m), as defined

$$S_r = 0.002(240 + L) \quad (\text{m})$$

$S_r = 0.76$  (m), for watertight bulkheads, cargo hold bulkheads, superstructure and deck-house bulkheads

$l$  : stiffener span (m) measured along the top flange of the member

$\sigma$  : allowable bending stress (N/mm<sup>2</sup>)

$P$  or  $P_{sl}$  : design pressure (kN/m<sup>2</sup>) as defined in **Ch 2**.

$Z_A$  : midship section modulus (cm<sup>3</sup>), as built at deck or bottom respectively

$Z_R$  : midship section modulus (cm<sup>3</sup>), as defined in **401**.

$k_a$  : correction factor for aspect ratio of plating field, see **Table 3.3.1**.

$k_r$  : correction factor for curved plating, as following formula

$$k_r = (1 - 0.5 S/r)$$

$r$  : radius of curvature (m)

$K$  : material factor in **Table 3.3.2**, as defined in **Table 2.1.5. of Pt 2, Ch 1. of Rules for the Classification of Steel Ships**.

**Table 3.3.1 Correction Factor ( $k_a$ )**

$s/l$	$k_a$
$1.0 = s/l$	0.72
$0.4 < s/l < 1.0$	$(1.1 - 0.25s/l)^2$
$s/l = 0.4$	1.0

**Table 3.3.2 Material Factor ( $K$ )**

Material notation	$K$
$RA, RB, RD, RE$	1.0
$RA32, RD32, RE32, RF32$	0.78
$RA36, RD36, RE36, RF36$	0.72
$RA40, RD40, RE40, RF40$	0.68

### 502. Keel plating

1. The keel plating is to extend over the complete length of the craft. The breadth is not to be less than that obtained from the following formula :

$$b = 750 + 4.5L \quad (\text{mm})$$

2. The thickness of keel plating is not to be less than the values according to the formula below. The thickness is, in no case, to be less than that of the adjacent bottom plating.

$$t = (7.0 + 0.05L) \frac{S}{S_r} \quad (\text{mm})$$

$S/S_r$  is not to be taken less than 0.5 or greater than 1.0.

### 503. Bottom and bilge plating

1. The thickness of bottom and bilge plating is not to be less than that obtained from the following formula :

$$t_1 = \frac{15.8S\sqrt{P \text{ or } P_{sl}}}{\sqrt{\sigma}} \quad (\text{mm})$$

The following extended formula for thickness of plating exposed to lateral pressure may be used when relevant.

$$t_2 = \frac{15.8k_a k_r S \sqrt{PK \text{ or } P_{sl}K}}{\sqrt{\sigma}} \quad (\text{mm})$$

$S$ ,  $k_a$ ,  $k_r$  and  $K$  : as defined in **501**.

$P$  : sea pressure or internal tank pressure, as defined in **Ch 2, 304** or **305**.

$P_{sl}$  : static pressure equivalent to slamming, as defined in **Ch 2, 301**.

$s$  : allowable stress, as defined in **Table 3.3.3**. Between specified regions the  $s$ -value may be varied linearly.

**Table 3.3.3 Allowable Stress ( $\sigma$ )**

Position	$\sigma$ (N/mm <sup>2</sup> )
Within 0.4 $L$	120 for $P$
	160 for $P_{sl}$
0.1 $L$ from perpendicular	160

2. The thickness of bottom and bilge plating is not to be less than that obtained from the following formula :

$$t_{\min} = (5.0 + 0.04L) \frac{S}{S_r} \quad (\text{mm})$$

$S/S_r$  is not to be taken less than 0.5 or greater than 1.0.

3. The thickness of bilge plating is not to be less than that of the adjacent bottom and side platings, whichever is the greater.
4. Plating in way of rudder bearings, shaft brackets, etc. may have to be increased to 2 times that of the adjacent platings.

#### 504. Side plating

1. The thickness of side plating is not to be less than that obtained from the following formula :

$$t_1 = \frac{15.8S \sqrt{P \text{ or } P_{sl}}}{\sqrt{\sigma}} \quad (\text{mm})$$

The following extended formula for thickness of plating exposed to lateral pressure may be used when relevant.

$$t_2 = \frac{15.8 k_a k_r S \sqrt{PK \text{ or } P_{sl}K}}{\sqrt{\sigma}} \quad (\text{mm})$$

$S$ ,  $k_a$ ,  $k_r$  and  $K$  : as defined in **501**.

$P$  : as defined in **503. Par 1**.

$P_{sl}$  : as defined in **Ch 2, 302** or **303**.

$\sigma$  : allowable stress, as defined in **Table 3.3.4**

2. The thickness of side plating is not to be less than formula defined in **503. Par 2**.

**Table 3.3.4 Allowable Stress of Side Plating**

	Position	$\sigma^{(1)}$ (N/mm <sup>2</sup> )
Longitudinal Stiffening	Within 0.4 $L$ at neutral axis	180
	Within 0.4 $L$ at deck or bottom - pressure ( $P$ ) - slamming pressure ( $P_{sl}$ )	120 160
	Within 0.1 $L$ from perpendiculars	180
Transverse Stiffening	Within 0.4 $L$ at neutral axis	160
	Within 0.4 $L$ at deck or bottom - pressure ( $P$ ) - slamming pressure ( $P_{sl}$ )	60 $Z_A/Z_R$ max. 120 120 $Z_A/Z_R$ max. 160
	Within 0.1 $L$ from perpendiculars	160
NOTE: (1) Between specified regions the $s$ -value may be varied linearly.		

### 505. Sheer strake at strength deck

1. The breadth of sheer strake is not to be less than that obtained from the following formula :

$$b = 800 + 5L \quad (\text{mm})$$

2. The thickness of monohull craft with  $L > 50\text{m}$  is not to be less than that obtained from the following formula :

$$t = \frac{t_1 + t_2}{2} \quad (\text{mm})$$

$t_1$  : required thickness of side plating, defined in **504**.

$t_2$  : thickness of strength deck plating, defined in **506**.  $t_2$  is not to be taken less than  $t_1$ .

3. If the end bulkhead of a superstructure is located within 0.5  $L$  amidships, the side plating should be given a smooth transition to the sheer strake below.

- (1) The range for the sheer strake with increase thickness

$$L < 60 \text{ m} \quad : L/25$$

$$L \geq 60 \text{ m} \quad : 2.5 \text{ m}$$

- (2) The increase thickness of sheer strake

$$L < 60 \text{ m} \quad : (1 + 0.005 L) \text{ times of thickness, defined in previous Par 2.}$$

$$L \geq 60 \text{ m} \quad : 1.3 \text{ times of thickness, defined in previous Par 2.}$$

### 506. Strength deck plating

1. The thickness of strength deck plating is not to be less than that obtained from the following formula :

$$t = (t_0 + 0.025L) \frac{S}{S_r} \quad (\text{mm})$$

$t_0$  : defined in **Table 3.3.5** considering that deck position and  $S/S_r$  is not to be taken values

defined in **Table 3.3.5**.

**Table 3.3.5 Minimum Thickness ( $t_0$ ) and Stiffener Spacing Ratio ( $S/S_r$ )**

Deck	$t_0$	$S/S_r$
Unsheathed weather and cargo decks	5.0	1.0
Accommodation deck	4.5	0.5
Weather and cargo deck sheathed with wood or an approved composition		

- If the end bulkhead of a long superstructure is located within  $0.5L$  amidship, the stringer plating is to be increased in thickness for a length of 3 m on each side of the superstructure end bulkhead. The increase in thickness is to be 20%.
- If hatch opening corners of streamlined shape are not adopted, the thickness of deck plating in strength deck at hatch corners is to be increased by 25%.

### 507. Plating of deck below or above strength deck

- The thickness of deck plating below or above strength deck is not to be less than following formula, and the deep tank boundary deck plating is not to be less than the thickness, defined in **508**.

$$t = (t_0 + 0.02L) \frac{S}{S_r} \quad (\text{mm})$$

$t_0$  : defined in **Table 3.3.6** considering that deck position and  $S/S_r$  is not to be taken values defined in **Table 3.3.6**.

**Table 3.3.6 Minimum Thickness ( $t_0$ ) and Stiffener Spacing Ratio ( $S/S_r$ )**

Deck	$t_0$	$S/S_r$
Unsheathed weather and cargo decks	4.5	1.0
Accommodation deck		
Weather and cargo deck sheathed with wood or an approved composition	4.0	0.5

### 508. Bulkhead plating

- The thickness of bulkhead or tank boundary bulkhead is not to be less than that obtained from the following formula :

$$t_1 = \frac{15.8 S \sqrt{P}}{\sqrt{\sigma}} \quad (\text{mm})$$

The following extended formula for thickness of plating may be used when relevant.

$$t_2 = \frac{15.8 k_a k_r S \sqrt{PK}}{\sqrt{\sigma}} \quad (\text{mm})$$

$S$ ,  $k_a$ ,  $k_r$  and  $K$  : as defined in **501**.



- $P$  : design load, defined in Ch 2, 305.  
 $\sigma$  : allowable stress, defined in Table 3.3.7.

Table 3.3.7 Allowable Stresses of Bulkheads

Bulkheads and locations				$\sigma^{(1)}$ (N/mm <sup>2</sup> )
Longitudinal bulkheads	Transverse stiffening	Within 0.4 $L$	Neutral axis	140
			Deck or bottom	60 $Z_A/Z_R$ , max. 120
		Within 0.1 $L$ from perpendiculars		160
	Longitudinal stiffening	Within 0.4 $L$	Neutral axis	160
			Deck or bottom	120
		Within 0.1 $L$ from perpendiculars		160
Transverse bulkheads (tank and cargo hold bulkheads)				160
Collision bulkhead				160
Other watertight bulkheads				220
NOTE: (1) Between specified regions the $s$ -value may be varied linearly.				

2. The thickness of the tank boundary bulkhead is not to be less than that obtained from the following formula :

$$t = (5 + 0.025L) \frac{S}{S_r} \quad (\text{mm})$$

$S/S_r$  is not to be taken less than 0.5 or greater than 1.0.

3. The thickness of other bulkhead is not to be less than that obtained from the following formula. However the thickness is not to be less than 3.0 mm.

$$t = 8S \quad (\text{mm})$$

4. For platings in afterpeak bulkhead in way of sterntube, increased thickness or doubling may be required.

### 509. End bulkheads of superstructures and deckhouses, and exposed sides in deckhouses

1. The thickness of end bulkheads of superstructures and deckhouses and exposed sides in deckhouse bulkhead is not to be less than that obtained from the following formula :

$$t = 1.25 S \sqrt{P} \quad (\text{mm})$$

$P$  : design load, defined in Ch 2, 307.

2. The thickness of end bulkheads of superstructure and deckhouse is not to be less than that obtained from the following formula :

(1) For the lowest tier

$$t = (5.0 + 0.01L) \frac{S}{0.76} \quad (\text{mm})$$

$S$  is not to be taken less than 0.38.

(2) For higher tiers :  $t = 6.5S$  (mm)

$t$  is not to be taken less than 2.5 mm

### 510. Machinery casings

The thickness of machinery casings protected by closed superstructure and deckhouse is not to be less than the following formula. However, thickness is not to be less than 4.0 mm.

(1) Machinery casings in cargo holds :  $t = 8.5S$  (mm)

(2) Machinery casings in accommodation area :  $t = 6.5S$  (mm)

### 511. Bulwark plating

#### 1. The thickness of bulwark

(1) The thickness of bulwark plating is not to be less than required for side plating in a superstructure in the same position if the height of the bulwarks is 1.8 m.

(2) If the height of bulwark is 1 m or less, the thickness need not be greater than that obtained from the following formula :  $t = 80S$  (mm)  
maximum : 6 mm, minimum : 3 mm

(3) For intermediate heights, the thickness of the bulwark may be found by interpolation.

2. Long bulwarks are to have expansion joints within 0.6  $L$  amidship.

3. Where bulwarks are on exposed decks form wells, ample provision is to be made for freeing the decks of water.

4. Bulwarks for ships with  $L > 50$  m are in general not to be welded to the top of the sheer strake within 0.6  $L$  amidship. Such weld connections may, however, be accepted upon special consideration of design, thickness and material grade.

## Section 6 Stiffeners

### 601. General

1. Where the angle between the web of stiffeners and shell plating is less than  $75^\circ$  the section modulus is to be suitably increased above the normal requirements and, where necessary, the tripping brackets should be fitted.

2. Unless specified otherwise, the section modulus of members required by the rules are those including steel platings with the effective breadth of  $0.1l$  is not to exceed one-half of the spacing of member.  $l$  is the length specified in the relevant chapter.

3. Equal angles should be avoided for full bending due to reduced effective free flange by torsional stresses, and tripping effects.

4. The thickness of web and flange is not to be less than the following values, defined in **Table 3.3.8**.

**Table 3.3.8 Scantlings of Stiffeners**

Structures		Scantling
Thickness of flat bar		1/15 × flat depth
Profile	Thickness of web	1/50 × web depth(in case, net shear area ≥ 0.075 <i>l</i> )
	Thickness of flange	1/15 × flange width

### 602. Longitudinals

- The section modulus of bottom, side longitudinals, longitudinal beams and longitudinal stiffeners in longitudinal bulkhead is not to be less than that obtained from the following formula :

$$Z_1 = \frac{k(P \text{ or } P_{sl})Sl^2}{\sigma} \quad (\text{cm}^3)$$

However, the following extended formula may be used when necessary.

$$Z_2 = \frac{1000(P \text{ or } P_{sl})Sl^2}{m\sigma} \quad (\text{cm}^3) \quad (2020)$$

*l* : span of the stiffeners (m), defined in **Ch 3, 107**.

*S* : spacing of stiffeners (m).

*m* : bending moment factor, defined in **Table 3.3.12**, for load and boundary conditions, not defined in **Table 3.3.12** *m*-values are directly from general elastic bending theory.

*K* : material factor, defined in **Table 3.3.2**.

*P* or *P<sub>sl</sub>* : load or impact pressure, defined in **Ch 2**.

*k* : 83

$\sigma$  : allowable stress, defined in **Table 3.3.9**. Between specified regions the  $\sigma$ -value may vary linearly.

- The bottom longitudinals should preferably be continuous through transverse members. If they are to be cut at transverse members, continuous brackets connecting the ends of the longitudinals are to be fitted.
- In case of a keel plating, the distance between the center girder and the first longitudinal should not exceed 400 mm.

**Table 3.3.9 Allowable Stress of Longitudinals (2020)**

Locations		$\sigma$ (N/mm <sup>2</sup> )
Within 0.4 <i>L</i>	Deck or bottom	95, $Z_A = Z_R$ (150 for planning slam) 160, $Z_A \geq 2Z_R$
	Within 0.25 <i>D</i> above and below the neutral axis	160/ <i>K</i>
0.1 <i>L</i> from the perpendiculars		160/ <i>K</i>
Decks and tops of short superstructures		160/ <i>K</i>

### 603. Transverse frames

The section modulus of transverse frames is not to be less than the greater of following formula.

$$Z_1 = 0.63 (P \text{ or } P_{sl}) S l^2 \quad (\text{cm}^3)$$

$$Z_2 = k\sqrt{L} \frac{S}{S_r} \quad (\text{cm}^3)$$

$k$  : the values in accordance of locations.

= 6.5, below freeboard deck and in forepeak to the deck above freeboard deck.

= 4.0, elsewhere.

$l$ ,  $S$ ,  $P$  and  $P_{sl}$  : defined in **602**.

$S_r$  : basic spacing of stiffeners (m).

### 604. Lower frames

1. The lower frames are frames located outside the peak tanks, connected to the floors by strong brackets.

2. The section modulus of lower frames is not to be less than the greater of following the formula.

$$Z_1 = 0.5 (P \text{ or } P_{sl}) S l^2 \quad (\text{cm}^3)$$

$$Z_2 = 6.5\sqrt{L} \frac{S}{S_r} \quad (\text{cm}^3)$$

$l$ ,  $S$ ,  $P$  and  $P_{sl}$  : defined in **602**.

$S_r$  : basic spacing of stiffeners (m).

3. The sectional modulus for lower frame is not to be less than that for the above frame.

4. The requirement given in **Par 2** is based on the mid-span moment and on the assumption that effective brackets are fitted at the lower end. The length of brackets is not to be less than  $0.1 l_1$

( $l_1$  = span from top of bottom structure to upper span point). The section modulus of frame including bracket is not to be less than 2 times that of the section modulus (**Par 2** and **Par 3**) at top of bottom structure.

5. When the length of the free edge of the bracket is more than 40 times that of the plating thickness, a flange is to be fitted, the width being at least 1/15 of the length of the free edge.

6. If bracket at top of floor is omitted, the section modulus of the lower frames is to be increased by 75%. The frames are to have effective end connections.

### 605. Transverse beams

The sectional modulus of transverse beams is not to be less than that obtained from the following formula :

$$Z = 0.63 P S l^2 \quad (\text{cm}^3)$$

$l$ ,  $S$  and  $P$  : defined in **602**.

### 606. Bulkhead stiffeners other than longitudinals

1. The section modulus of bulkhead stiffeners other than longitudinals is not to be less than that obtained from the following formula :

$$Z = \frac{1000 P S l^2}{m \sigma} \quad (\text{cm}^3)$$

$l$ ,  $S$  and  $P$  : defined in **602**.

$S_r$  : basic spacing of stiffeners (m).

$\sigma$  : allowable stress, defined in **Table 3.3.10**.

$m$  : bending moment factor, defined in **Table 3.3.11**, for load and boundary conditions, not defined in **Table 3.3.11**,  $m$ -values are directly from general elastic bending theory.

**Table 3.3.10 Allowable Stresses of Bulkhead Stiffeners ( $\sigma$ )**

Locations	$\sigma$ (N/mm <sup>2</sup> )
Collision bulkhead, deep tank and cargo hold bulkhead	160
Other watertight bulkheads	220

**Table 3.3.11 Bending Moment Factor ( $m$ )**

Locations and boundary conditions		$m$
Deep tank and cargo hold bulkhead		10.0
Watertight bulkhead	Fixed at both ends	16.0
	Fixed at one lower end and simply supported at the other	12.0
	Simply supported at both ends	8.0

2. The end attachment of the stiffeners is to comply with the following.

(1) For tank, cargo and collision bulkheads : Bracket to be fitted at both ends, defined in **612**.

(2) Transverse watertight bulkheads : Brackets are normally to be fitted at both ends. Brackets may be omitted when the distance from top of bulkhead to lower end of span is less than 6.0 (m).

### 607. End bulkheads of superstructure and deckhouse, and exposed sides in deckhouse

1. The section modulus of stiffeners is not to be less than that obtained from the following formula :

$$Z = 0.63 P S l^2 \quad (\text{cm}^3)$$

$l$ ,  $S$  and  $P$  : defined in **602**.

2. Front stiffeners are to be connected to deck at both ends with connection areas not less than that of the following formula. Side and after end stiffeners in the lowest tier of erections are to have end connections.

$$a = 0.07 P S l^2 \quad (\text{cm}^2)$$

$l$ ,  $S$  and  $P$  : defined in **602**.

3. When the poop front bulkhead is forming part of the engine room casing, the stiffeners are to have bracketed end connections.

4. In long deckhouses, openings in the sides are to have well rounded corners. Horizontal stiffeners are to be fitted at the upper and lower edge of large openings for windows.

### 608. Machinery casings

The section modulus of stiffeners is not to be less than that obtained from the following formula :

$$Z = 3 S l^2 \quad (\text{cm}^3)$$

$l$  : length of stiffeners (m), minimum 2.5 m.

$S$  : spacing of stiffener (m).

### 609. Bulwark stiffening

1. A strong bulb section or similar is to be continuously welded to the upper edge of the bulwark.
2. Bulwark stays are to be spaced not more than 2 m apart, and are to be in line with transverse beams or local transverse stiffening. Alternatively the toe of stay may be supported by a longitudinal member. The deck beam is to be continuously welded to the deck in way of stay.
3. Bulwarks on forecastle decks are to have stays fitted at every frame where the flare is considerable.
4. Stays of increased strength are to be fitted at ends of bulwark openings. Openings in bulwarks should not be situated near the end of superstructures.

### 610. Weather deck hatch covers and shell doors

1. The section modulus of stiffeners is given in **602**. However, the coefficient ( $k$ ) and allowable stress are defined as follows:

$$k = 125$$

$$\sigma = 135$$

2. The moment of inertia is not to be less than that obtained from the following formula :

$$I = 1.7 Z l \quad (\text{cm}^4)$$

### 611. Doors in watertight bulkheads

The section modulus of stiffeners is given in **602**. The coefficient ( $k$ ) and allowable stress are defined as follows:

$$k = 125, \quad \sigma = 200$$

### 612. End connections of stiffeners

1. Normally all types of stiffeners (longitudinals, beams, frames, bulkhead stiffeners) are to be connected at their ends, defined in **Par 2**. Sniped ends may be allowed.
2. The arm lengths of brackets for stiffeners is not to be less than that obtained from the following formula (refer to **Fig 3.3.4**).

$$a = C \sqrt{\frac{Z}{t}} \quad (\text{mm})$$

$C = 70$ , flanged brackets.

75, unflanged brackets.

$Z$  : rule section modulus ( $\text{cm}^3$ ).

$t$  : thickness of brackets (mm).

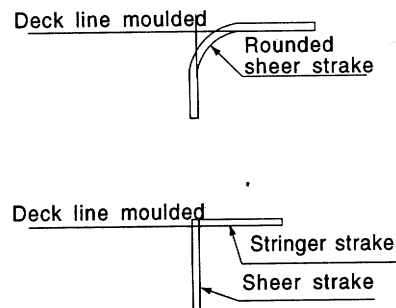

Fig 3.3.4 Stiffener Brackets

3. The arm length is in no case to be taken less than 2 times the depth of the stiffener and brackets to be flanged if free lengths exceed  $40 t$ .
4. Bracketless end connections may be applied to longitudinals and other stiffeners running continuously through girders.
5. End connection of the bottom and strength deck longitudinals is applied as below :
  - (1) The longitudinals are normally to be continuous at transverse members within  $0.5 L$  amidship.
  - (2) The longitudinals may be cut at transverse members. In that case, continuous brackets connecting the ends of the longitudinals are to be fitted.
6. Stiffeners with snipped ends may be allowed in compartments and tanks where dynamic loads are small and where vibrations are considered to be of limited importance, provided the thickness of plating supported by the stiffener is not less than that obtained from the following formula :

$$t = 1.25\sqrt{(1 - 0.5S)SP}$$

$l$  : stiffener span (m).

$S$  : stiffener spacing (m).

$P$  : pressure on stiffener ( $\text{kN/m}^2$ ).

## Section 7 Transverses and Girders

### 701. General

#### 1. Transverse arrangement

- (1) Transverses are to be continuous around the cross section ; i.e., bottom, side and deck transverses, and have enough transverse strength.
- (2) Transverse spacing, defined above in (1), is 4 times of  $S_r$  defined in **501**, and bottom transverse spacing is 2 times of  $S_r$ .

#### 2. Support of erections

In superstructures and deckhouses aft, the front bulkhead is to be in line with a transverse bulkhead in the hull below or be supported by a combination of partial transverse bulkheads, girders and pillars.

### 702. Transverses and girders

1. The section modulus for transverses and girders supporting longitudinals, vertical frames, transverse beams or bulkhead stiffeners is not to less than that obtained from the following formula :

$$Z = \frac{1000KFR(P_{or}P_{sl})bS_g^2}{m\sigma} \quad (\text{cm}^3)$$

$F$  : for ship side only. It depends on whether or not cross ties support the side transverse, is fitted or not.

= 1.0 where no cross tie is fitted.

= 0.5 where 1 cross tie is fitted.

$R$  : rise of floor correction factor, as in the following formula.  $R$  is not to be taken less than 0.7.

$$R = 1.0 - f/S$$

$f$  and  $S$  : as defined in **Fig 3.3.5**.

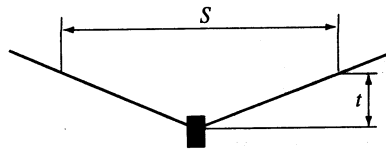

**Fig 3.3.5**  $f$  and  $S$

$m$  : bending moment factor, defined in **Table 3.3.12**.

= 10, average bottom, side, deck transverse, deck girders and vertical bulkhead webs.

= 12, average stringers.

$\sigma$  : allowable stress, defined in **Table 3.3.9** for continuous longitudinal girder.

= 160, other girders.

$K$  : material factor, defined in **501**.

$S_g$  : girder or transverse span (m).

$b$  : breadth of load area (m), defined in following formula.

$$b = 0.5(l_1 + l_2) \quad (\text{m})$$

$l_1$  and  $l_2$  : spans (m) of the supported stiffeners

$P$  or  $P_{sl}$  : design pressure ( $\text{kN/m}^2$ ), defined in **Ch 2**.

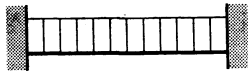
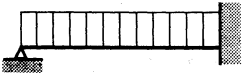
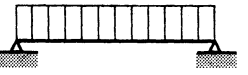
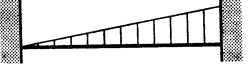
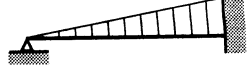
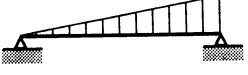

Table 3.3.12 Values of  $m$  and  $K_S$

Load and boundary conditions			Boundary moment and shear force factors		
Positions			1	2	3
1 Support	2 Field	3 Support	$m_1$ $k_{S1}$	$m_2$ -	$m_3$ $k_{S3}$
			12.0 0.50	24.0	12.0 0.50
			0.38	14.2	8.0 0.63
			0.50	8.0	0.50
			15.0 0.30	23.3	10.0 0.70
			0.20	16.8	7.5 0.80
			0.33	7.8	0.67

2. The effective web area of transverses and stringers supporting longitudinals or other stiffeners is not to be less than that obtained from the following formula :

$$A_w = \frac{10K[k_s F_S S_S b R(P \text{ or } P_{st}) - ar]}{\tau} \quad (\text{cm}^2)$$

$k_s$  : shear force factor, defined in **Table 3.3.13**, may be adjusted **Table 3.3.12**.

$F_S$  : factor, depended on whether cross ties is fitted or not, defined in **Table 3.3.14**.

$S_S$  :  $S_g$ , when no cross tie.

: span to a cross tie, when fitted.

$a$  : number of stiffeners between considered section and nearest support.

$r$  : average point load (kN) from stiffeners between considered section and nearest support.

$\tau$  : allowable shear stress (N/mm<sup>2</sup>).

= 120 (N/mm<sup>2</sup>) for watertight bulkheads.

= 90 (N/mm<sup>2</sup>) for elsewhere.

$R$  and  $K$  : defined in above **Par 1**.

Table 3.3.13 Shear Factor ( $k_s$ )

Load	Lower end of vertical span	Upper end and horizontal span
Slamming impact	0.8	0.65
Other pressure	0.75	0.55

Table 3.3.14 Factor ( $F_s$ )

	Cross tie fitted	No cross tie
Cross tie end	0.5	1.0
Opposite end	0.7	1.0

### 703. Girders supporting other girders or pillar

- The section modulus of girders supporting other girders or pillar is not to be less than that obtained from the following formula :

$$Z = \frac{1000 K P S}{m \sigma} \quad (\text{cm}^3)$$

$P$  : load (kN) from supported girder or pillar.

$m$  : 5.5

$\sigma$  : allowable stress (N/mm<sup>2</sup>), as follows.

Continuous longitudinal girder : defined in **Table 3.3.9**.

Watertight bulkheads : 220 N/mm<sup>2</sup>

Other bulkheads : 160 N/mm<sup>2</sup>

- The effective web area is not to be less than that obtained from the following formula :

$$A_w = \frac{10 K k_s P}{\tau} \quad (\text{cm}^2)$$

$k_s$  : shear force factor, 0.55 at half-span.

$\tau$  : defined in **702**.

### 704. Effective breadth of girders

The effective breadth of girders is to be in accordance with **601. Par 2**.

### 705. Bottom transverses and girders

- The scantlings of bottom transverses and girders should comply with the requirements in **702**.
- The center girder is normally to be fitted for docking purpose, if docking on a keel plating is foreseen. The docking center girder is to have height, web thickness and flange area suitable for the docking block load. The spacing of docking brackets is to be less than  $S_r$ , defined in **501**.
- Side girders for stabilizing purposes are normally to have spacing not exceeding 2.5 m. Forward of 0.25L from F.P. the spacing should not exceed 1.25 m if the rise of floor is less than 15°
- In the engine room plate floor spacing is to be less than of  $S_r$ , as defined in **501**.

### 706. Side transverses and stringers

- The scantlings of side transverses and stringers are to comply with the requirements in **702**.
- Vertical webs in the engine room and within 0.1 L from the perpendiculars are to have a depth not less than that indicated in the following formula. It is not necessary to exceed 200 S (mm).

$$h = 2LS \quad (\text{mm})$$

$S$  : span of side transverse (m).

- In engine room and within  $0.1L$  from A.P. the total flange width is not to be less than  $35S$  (mm).

### 707. Cross ties

Cross tie and panting beam scantlings are to be determined as for deck pillars, deck load being substituted by the supported craft side load.

### 708. Deck transverses and girders

- The scantlings of deck transverses and girders are to comply with the requirements in **702**.
- For transverses in strength deck for  $L > 50$  m, supporting longitudinals subject to axial compression stresses the moment of inertia of the girder section (including effective plate flange) is not to be less than following formula. When  $\sigma_a > 100 \text{ N/mm}^2$ , the moment of inertia is to be in accordance with the satisfaction of the Society.

$$I = 0.17A \frac{S_g^4 \sigma_a}{100l S} \quad (\text{cm}^4)$$

$A$  : sectional area ( $\text{cm}^2$ ) of longitudinal including  $0.8S$  plating flange.

$S_g$  : span (m) of transverse.

$l$  : distance (m) between transverses.

$S$  : spacing (m) of longitudinals.

$\sigma_a$  : actual compressive stress ( $\text{N/mm}^2$ ) estimated from hull girder strength calculation.

- The depth of the deck transverse in the engine room is to be at least 50% the depth of the side transverses, web thickness and face plate scantlings as for side transverses.

### 709. Bulkhead vertical webs and stringers

The scantlings of bulkhead vertical webs and stringers are to comply with requirements in **702**.

### 710. End connections of girders

- Normally, ends of single girders or connections between girders forming ring systems are to be provided with brackets. Brackets are generally to be radiused or well rounded at their toes. The free edge of the brackets is to be stiffened in accordance with **Par 4**.
- The thickness of brackets on girders is not to be less than that of the girder web plating.
- The arm length including depth of girder web may normally be taken as following formula :

$$a = 63 \sqrt{\frac{Z}{t}} \quad (\text{mm})$$

$Z$  : rule section modulus ( $\text{cm}^3$ ) of the strength member to which the bracket is connected.

$t$  : thickness of bracket (mm).

- Flanges on girder brackets are normally to have a cross sectional area not less than that obtained from the following formula:

$$A = lt \quad (\text{cm}^2)$$

$l$  : length of free edge of brackets (m).  
 $t$  : defined in **Par 3**.

5. The thickness of the web plating at the cross joint of bracketless connections (refer to **Fig 3.3.6**), is not to be less than the greater of the following formulae.

$$t_3 = \frac{\sigma_1 A_1}{\tau_2 h_2} \quad (\text{mm})$$

$$t_3 = \frac{\sigma_2 A_2}{\tau_1 h_1} \quad (\text{mm})$$

$A_1, A_2$  : flange area ( $\text{cm}^2$ ) of girder 1 and 2.  
 $\sigma_1, \sigma_2$  : bending stresses ( $\text{N}/\text{mm}^2$ ) of girder 1 and 2.  
 $\tau_1, \tau_2$  : shear stresses ( $\text{N}/\text{mm}^2$ ) of girder 1 and 2.  
 $h_1, h_2$  : height (mm) of girder 1 and 2.

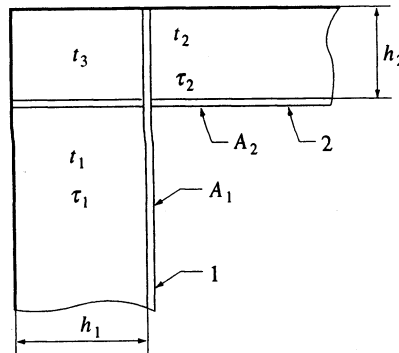

**Fig 3.3.6 Bracketless Joint**

### 711. Tripping brackets

1. The spacing ( $S_T$ ) of tripping brackets is normally not to exceed the values given in **Table 3.3.15**.
2. Tripping brackets on girders are to be stiffened by a flange or stiffener along the free edge if the length of the edge exceeds following formula.

$$F_e = 0.06 t_t \quad (\text{m})$$

$t_t$  : thickness (m) of tripping bracket.

The area of the stiffening is not to be less than that obtained from the following formula :

$$A_F = 10 l_t \quad (\text{cm}^2)$$

$l_t$  : length (m) of free edge.

**Table 3.3.15 Spacing between Tripping Brackets**

Girder type		$S_T$ (mm)
Girders with symmetrical face plate	<ul style="list-style-type: none"> <li>- Bottom and deck transverses</li> <li>- Stringers, vertical webs and</li> </ul>	$0.02 b_f$ max. 6 m
	<ul style="list-style-type: none"> <li>- Longitudinal girders in bottom and strength deck for <math>L &gt; 50</math> m within <math>0.5 L</math> amidships</li> <li>- Stringers and vertical webs in tanks and machinery spaces</li> <li>- Vertical webs supporting single bottom girders and transverses</li> </ul>	$0.014 b_f$ max. 4 m
Girders with unsymmetrical face plate		not more than 10 times the width of face plate max. 1.5 m
If the web of a strength member forms an angle with the perpendicular to the craft's side of less than $80^\circ$ , $S_T$ is to exceed $0.007 b_f$		
NOTE :		
$b_f$ = flange breadth (mm)		
$S_T$ = distance (m) between transverse girders.		

### 712. Girder web stiffeners

The web plating of transverse and vertical girders are to be stiffened where, defined in **Table 3.3.16**.

**Table 3.3.16 Girder Web Stiffeners**

	Web height (mm)	Max. spacing of stiffeners (mm)
<ul style="list-style-type: none"> <li>- Within 20 % of the span from each of the girder</li> <li>- Where high shear stresses</li> </ul>	$h_W > 90 t_W$	$S = 90 t_W$
<ul style="list-style-type: none"> <li>- Elsewhere</li> </ul>	$h_W > 140 t_W$	$S = 140 t_W$
$h_W$ = web height (mm).		
$t_W$ = web thickness (mm).		

## Section 8 Pillars

### 801. General

1. Pillars in between decks are to be arranged directly above those under the deck, or effective means are to be provided for transmitting their loads to the supports belows.
2. Pillars are to be arranged below superstructures, deckhouses, windlasses and other heavy weights.
3. Doublers are to be fitted on deck and inner bottom, except in tanks where doublers are not allowed.

### 802. Pillar scantlings

The sectional area is not to be less than that obtained from the following formula :

$$A = \frac{K_1}{\eta_G} P \quad (\text{cm}^2)$$

$P$  : supported load ( $kN$ ), defined in Ch 2.

$K_1$  : defined in Table 3.3.17.

$l$  : length (m) of pillar.

$i$  : radius of gyration (cm), as following formula.

$$i = \sqrt{\frac{I}{A}} \quad (\text{cm})$$

$I$  : smallest moment of inertia ( $\text{cm}^4$ ).

$A$  : cross-sectional area ( $\text{cm}^2$ ) of pillar.

$\eta_G$  : correction factor for buckling, as following formula.

$$\eta_G = \frac{P_s + 0.5P_d}{P_s + P_d}$$

$P_s$  and  $P_d$  : static and dynamic load of  $P$ .

**Table 3.3.17 Values of  $K_1$**

$l/i$	0.3	0.4	0.5	0.6	0.7	0.8	0.9	1.0	1.1	1.2	1.3 and greater
$k_1$	0.057	0.063	0.069	0.076	0.084	0.094	0.105	0.119	0.136	0.158	$0.113 (l/i)^2$

### 803. Pillars in deep tanks

1. Hollow pillars are not accepted in deep tanks.
2. Where the hydrostatic pressure may give tensile stresses in the pillars and cross members, their sectional area is not to be less than that obtained from the following formula :

$$A = 0.07 A_{dk} P_t \quad (\text{cm}^2)$$

$A_{dk}$  : deck or side area ( $\text{m}^2$ ) supported by the pillar or cross member.

$P_t$  : design pressure ( $\text{kN/m}^2$ ) giving tensile stress in the pillar.

### 804. Pillar bulkheads

The transverse bulkheads supporting the longitudinal deck girders, and the longitudinal bulkheads provided in lieu of pillars, are to be stiffened in a manner to provide supports not less effective than those required for pillars. ↓

## CHAPTER 4 STRUCTURE PRINCIPLES IN ALUMINIUM ALLOY

### Section 1 General

#### 101. Application

1. The hull structure, constructed in aluminium alloy complying with the requirements in **Sec 2**, is to be in accordance with requirements in this chapter.
2. Requirements, not included in this chapter, are to be in accordance with those in **Ch 3**.

#### 102. The scantling reduction

1. The requirements, except for those in the **Par 2** below, are to be in accordance with **Ch 3**.
2. Basic stiffener spacing,  $S_s = 0.002(100 + L)$  (m)

#### 103. Bottom structures

##### 1. Longitudinal stiffeners

- (1) Single bottom as well as double bottoms are normally to be stiffened longitudinally.
- (2) The longitudinals should preferably be continuous through transverse members. If they are to be cut at transverse members, (i.e., watertight bulkheads), continuous brackets connecting the ends of the longitudinals are to be fitted.
- (3) Longitudinal stiffeners are to be supported by bulkheads and transverses.

##### 2. Transverses

- (1) Transverses are to be continuous around the cross section : i.e., floors, side webs and deck beams are to be connected. Intermediate floors may be used.
- (2) In the engine room plate floors are to be fitted at every frame. In way of thrust bearings additional strengthening is to be provided.

##### 3. Longitudinal girders

- (1) Web plates of longitudinal girders are to be continuous in way of transverse bulkheads.
- (2) A center girder is normally to be fitted for docking purposes.
- (3) Manholes or other openings should not be positioned at ends of girders without due consideration being taken of shear loadings.

##### 4. Engine girders

- (1) Under the main engine, girders extending from the bottom to the top plate of the engine seating are to be fitted.
- (2) Engine holdingdown bolts are to be arranged as near as practicable to floors and longitudinal girders.
- (3) In way of thrust bearing and below pillars additional strengthening is to be provided.

##### 5. Double bottom

- (1) Manholes are to be cut in the inner bottom, floors and longitudinal girders to provide access to all parts of the double bottom. The vertical extension of lightening holes is not to exceed one half of the girder height. The edges of the manholes are to be smooth. Manholes in the inner bottom plating are to have reinforcement rings. Manholes are not to be cut in the floors or girders in way of pillars.
- (2) In double bottoms with longitudinal stiffening, the floors are to be stiffened at every bottom longitudinal.
- (3) In double bottoms with transverse stiffening, longitudinal girders are to be stiffened at every transverse frame.
- (4) The longitudinal girders are to be adequately stiffened against buckling.

#### 104. Side structures

1. Side structures are normally to be longitudinally or vertically stiffened.
2. The continuity of the longitudinals is to be as required for bottom and deck longitudinal respectively.

#### 105. Deck structures

1. Decks are normally to be longitudinally stiffened.
2. The longitudinals should preferably be continuous through transverse members. If they are to be cut at transverse members, (i.e., watertight bulkheads), continuous brackets connecting the ends of the longitudinals are to be fitted.
3. The plate thickness is to be such that the necessary transverse buckling strength is achieved, or transverse buckling stiffeners may have to be fitted intercostally.

#### 106. Bulwarks

The scantlings of bulwarks are to be in accordance with **Ch 3, 511.** and **609.**

#### 107. Flat cross structures

The scantlings of flat cross structure are to be in accordance with **Ch 3, 104.**

#### 108. Bulkhead structures

The scantlings of bulkhead structures are to be in accordance with **Ch 3, 105.**

#### 109. Superstructures and deckhouses

1. In superstructures and deckhouses, the front bulkhead is to be in line with a transverse bulkhead in the hull below or be supported by a combination of girders and pillars. The after end bulkhead is also to be adequately supported. As far as practicable, exposed sides and internal longitudinal and transverse bulkheads are to be located above girders and frames in the hull structure, and are to be in line in the various tiers of accommodation. Where such structural arrangement in line is not possible, there is to be other effective support.
2. Sufficient transverse strength is to be provided by means of transverse bulkheads or girder structures.
3. At the break of superstructures, which have no set-in from craft side, the side plating is to extend beyond the ends of the superstructure, and is to be gradually reduced in height down to the deck or bulwark. The transition is to be smooth and without local discontinuities. A substantial stiffener is to be fitted at the upper edge of plating. The plating is also to be additionally stiffened.
4. In long deckhouses, openings in the sides are to have well rounded corners. Horizontal stiffeners are to be fitted at the upper and lower edges of large openings for windows. Openings for doors in the sides are to be substantially stiffened along the edges. The connection area between deckhouse corners and deck plating is to be increased locally.
5. Deck girders are to be fitted below long deckhouses in line with deckhouses sides.
6. Deck beams under front and aft ends of deckhouses are not to be scalloped for a distance of 0.5m from each side of the deckhouse corners.
7. Casings supporting one or more decks above are to be adequately strengthened.

#### 110. Definition of span (*l*)

The definition of span is in accordance with **Ch 3, 107.**



## Section 2 Materials and Welding

### 201. Materials

1. The materials used for hull construction and equipment shall comply with the **Pt 2, Ch 1**, unless otherwise specified. **The material factor is to be in accordance with the Guidance relating to the Rules. But others than the Guidance are to be as following formula: [See Guidance]**

$$K = \frac{240}{\sigma_f}$$

$\sigma_f$  : **yield stress (N/mm<sup>2</sup>, proof load with 0.2% permanent deformation) is not to be taken greater than 70% of the ultimate tensile strength. (2020)**

2. Where materials other than those specified in this chapter are used, the use of materials and corresponding scantlings including manufacturing process, chemical composition and mechanical properties are to be approved.

### 202. Welding

Welding and welding structures are to be in accordance with **Pt 2, Ch 2**.

## Section 3 Material Protection

### 301. General

1. All craft, complying with these rules, are to apply material protection.
2. All surfaces which are not resistant to the marine environment are to be protected against corrosion.
3. Material protection, not identified in this chapter, is to comply with **Ch 3, Sec 2**.

### 302. Approval

Specifications of corrosion protection systems, (i.e., for coating, cathodic protection, etc.), are subject to approval.

### 303. Corrosion protection

1. Antifouling paint is to be applied over anticorrosion coating.
2. Coatings are not to contain copper or other constituents which may cause galvanic corrosion.
3. Specifications for coating including antifouling, are to state :
  - (1) Metal surface cleaning and treatment before application of primer coat, including welds and edges
  - (2) Build-up of coating system with individual coats
  - (3) Curing times and overcoating intervals
  - (4) Acceptable temperatures of air and metal surface, and dryness/humidity conditions during above operations
  - (5) Thickness of individual and final coating

### 304. Other metallic materials in contact with aluminium

If other metallic materials in propeller, etc. are to be used on an aluminium hull, provisions are to be made to avoid galvanic corrosion. Acceptable provisions are either one or a combination of the followings :

- (1) Coating of water/moisture exposed surfaces
- (2) Electrical insulation of metals which differ from each other

(3) Cathodic protection

### 305. Cathodic protection

1. Cathodic protection of aluminium hull can be obtained with aluminium or zinc sacrificial anodes or impressed current.
2. Specifications of cathodic protection system include :
  - (1) Area to be protected
  - (2) Current density demand
  - (3) Anode material and manufacturer
  - (4) Calculation of service life and estimated protective potential to be obtained.
3. If impressed current systems are applied, precautions to avoid overprotection by means of anode screen and overprotection alarm are to be taken.

### 306. Connections between steel and aluminium

1. If there is risk of galvanic corrosion, a non-hygroscopic insulation material is to be applied between steel and aluminium.
2. Aluminium plating connected to a steel boundary bar is as far as possible to be arranged on the side exposed to moisture.
3. Direct contact between exposed wooden materials, and aluminium is to be avoided.
4. Bolts with nuts and washers are either to be of stainless steel or cadmium plated or hot galvanized steel. The bolts are in general to be fitted with sleeves of insulating materials.

## Section 4 Hull Girder Strength

### 401. Application

The hull girder strength of craft, constructed in aluminium alloy, is to be in accordance with **Ch 3, Sec 4. (2020)**

### 402. Additional requirements

1. Where the forebody parts are transversely framed, the axial force, defined in **Ch 2, 401. Par 6**, is to be checked the following formula.

$$F_L = \Delta g_0 a_l \quad (\text{kN})$$

$a_l$  : as defined in **Ch 2, 401. Par 6**.

The distribution of stresses will depend on instantaneous forward immersion and on location of cargo.

2. Bottom structure in way of thrust bearings may need a check for the increased thrust when craft is retarded by a crest in front.
3. Allowable axial stress and associated shear stresses are to be related to the stresses already existing in the region.

## Section 5 Platings

### 501. Allowable stresses

Maximum allowable bending stresses in platings and stiffeners are to be in accordance with **Table 3.4.1.**

**Table 3.4.1. Allowable Bending Stresses**

Structures	Plates	Stiffeners
Bottom, slamming load	200/ $K$	180/ $K$
Bottom, sea load	180/ $K$	160/ $K$
Side structures	180/ $K$	160/ $K$
Deck structures	180/ $K$	160/ $K$
Flat cross structure, slamming load	200/ $K$	180/ $K$
Flat cross structure, sea load	180/ $K$	160/ $K$
Collision bulkhead	180/ $K$	160/ $K$
Superstructure/deckhouse front	160/ $K$	140/ $K$
Superstructure/deckhouse side/deck	180/ $K$	160/ $K$
Watertight bulkhead	220/ $K$	200/ $K$
Deep tank bulkhead	180/ $K$	160/ $K$

### 502. Minimum thickness

The thickness of structures is normally not to be less than that obtained from the following formula :

$$t = (t_o + kL)\sqrt{K} \frac{S}{S_R} \quad (\text{mm})$$

$$K = \frac{240}{\sigma_f}$$

$\sigma_f$  : Yield stress in N/mm<sup>2</sup> at 0.2% offset for unwelded alloy.

$\sigma_f$  is not to be taken greater than 70% of the ultimate tensile strength.

$S$  : actual stiffener spacing (m).

$S_R$  : basic stiffener spacing, as following formula, however,  $S/S_R$  is not to be taken less than 0.5 or greater than 1.0.

$$S_R = 0.002(100 + L) \quad (\text{m})$$

$t_o$  and  $k$  : as defined in **Table 3.4.2.**

Table 3.4.2. Values of  $t_o$  and  $k$

Structures		$t_o$	$k$
Shell plating	Bottom, bilge and side to load line	4.0	0.03
	Side above load line	3.5	0.02
	Bottom aft in way of rudder, shaft brackets etc.	10.0	0.10
Deck and inner bottom plating	Strength deck weather part forward of amidships	3.0	0.03
	strength deck weather part aft of amidships	2.5	0.02
	Inner bottom	3.0	0.03
	Inner bottom of cargo hold	4.0	0.03
	Accommodation deck	2.0	0.02
	Deck for cargo	4.0	0.03
	Superstructure and deckhouse decks	1.0	0.01
Bulkhead plating	Collision bulkhead	3.0	0.03
	Tank bulkhead	3.0	0.03
	Other watertight bulkhead	3.0	0.02
	Superstructure and deckhouse front	3.0	0.01
	Superstructure and deckhouse sides and aft	2.5	0.01
Others	Foundations	3.0	0.08
	Structures not mentioned above	3.0	0.0

### 503. Thickness of platings

1. The general requirement to thickness of plating subject to lateral pressure is given by the following formula :

$$t = \frac{S\sqrt{CP}}{\sqrt{\sigma}} \quad (\text{mm})$$

$C$  : correction factor for aspect ratio of plating field and degree of fixation of plate edges, given in **Table 3.4.3**.

$S$  : stiffener spacing (m).

$P$  : design pressure, given in **Ch 2, Sec 3**.

$\sigma$  : allowable stress, given in **Table 3.4.1**.

Table 3.4.3 Values of  $C$

	Aspect ratio < 0.5				Aspect ratio = 1.0			
	$\sigma_l$	$\sigma_s$	$\sigma_x$	$\sigma_y$	$\sigma_l$	$\sigma_s$	$\sigma_x$	$\sigma_y$
Clamped along all edges	500	342	75	250	310	310	130	130
Longest edge clamped, shortest edge simply supported	500	0	75	250	425	0	140	200

$\sigma_l$  : stress at midpoint of longest edge.  
 $\sigma_s$  : stress at midpoint of shortest edge.  
 $\sigma_x$  : maximum field stress parallel to longest edge.  
 $\sigma_y$  : maximum field stress parallel to shortest edge.

2. The thickness requirement for a plating field clamped along all edges with an aspect ratio  $\leq 0.5$  is given by the following formula :

$$t = \frac{22.4 S\sqrt{P}}{\sqrt{\sigma}} \quad (\text{mm})$$

$S$ ,  $P$  and  $\sigma$  : as given in **Par 1**.

3. The thickness of the bottom plating is not to be less than that obtained from the following formula :

$$t = \frac{22.4 k_a k_r S\sqrt{P_{sl}}}{\sqrt{\sigma_{sl}}} \quad (\text{mm})$$

$k_a$  : correction factor for aspect ratio of plate field, as following **Table 3.4.4**

Table 3.4.4  $k_a$

$s/l$	$k_a$
$1.0 = s/l$	0.72
$0.4 < s/l < 1.0$	$(1.1 - 0.25 s/l)^2$
$s/l = 0.4$	1.0

$k_r$  : correction factor for curved plating, as following formula.

$$k_r = \left(1 - 0.5 \frac{S}{r}\right)$$

$r$  : radius of curvature (m).

$P_{sl}$  : slamming pressure ( $\text{kN/m}^2$ ), as given in **Ch 2**.

$\sigma_{sl}$  : allowable stress ( $\text{N/mm}^2$ ) in bottom plating, as following formula.

$$\sigma_{sl} = \frac{200}{K}$$

$l$  : stiffener span (m)

4. Above the slamming area, the thickness may be gradually reduced to the ordinary requirement at

side. For craft with rise of floor, however, reduction will not be accepted below the bilge curvature or chine.

## Section 6 Stiffeners

### 601. Section modulus

- The section modulus of stiffeners is not to be less than that obtained from the following formula :

$$Z = \frac{mPSl^2}{\sigma} \quad (\text{cm}^3)$$

$m$  : bending moment factor, defined in Table 3.4.5 for load and boundary conditions and for, not defined in previous Tables,  $m$ -values are directly from Table 3.4.9 and general elastic bending theory. (2020)

$l$  : span of the stiffeners (m).

$S$  : spacing of stiffeners (m).

$P$  : designed pressure, defined in Ch 2.

$\sigma$  : allowable stress, defined in Table 3.4.1.

**Table 3.4.5 Bending Moment Factor ( $m$ )**

Structures	$m$
Continuous longitudinal members	85
Non-continuous longitudinal members	100
Transverse members	100
Vertical members, and fixed	100
Vertical members, simply supported	135
Bottom longitudinal members	85
Bottom Transverse members	100
Side longitudinal members	85
Side vertical members	100
Deck longitudinal members	85
Deck Transverse members	100
W.T. bulkhead stiffeners, fixed ends	65
W.T. bulkhead stiffeners, fixed on ends (lower)	85
W.T. bulkhead stiffeners, simply supported ends	125
W.T. bulkhead horizontal stiffeners, fixed ends	85
W.T. Bulkhead horizontal stiffeners, simply supported	125
W.T. bulkhead stiffeners, fixed one ends (upper)	75
Tank cargo bulkhead, fixed ends	100
Tank cargo bulkhead, simply supported	135
Deckhouse stiffeners	100
Casing stiffeners	100

2. The values, defined in **Par 1**, are to be regarded as the requirement about an axis parallel to the plating. As an approximation the requirement to standard section modulus for stiffeners at an oblique angle with the plating may be obtained if the formula in **Par 1** is multiplied by the following factor.

$$\frac{1}{\cos\alpha}$$

$\alpha$  : angle between the stiffener web plane and the plane perpendicular to the plating. However, for  $\alpha$ -values less than  $12^\circ$  corrections are normally not necessary.

3. When several members are equal, the section modulus requirement may be taken as the average requirement for each individual member in the group. However, the requirement for the group is not to be taken less than 90 % of the largest individual requirement.
4. Front stiffeners of superstructures and deckhouses are to be connected to deck at both ends with a connection area not less than that obtained from the following formula :

$$a = 0.07 K P S l \quad (\text{cm}^2)$$

And, side and after end stiffeners in the lowest tier of erections are to have end connections.

5. The section modulus of longitudinals or transverse stiffeners supporting the bottom plating is not to be less than that obtained from the following formula :

$$Z = \frac{m P_{sl} S l^2}{\sigma_{sl}} \quad (\text{cm}^3)$$

$m$  : bending moment factor.

= 85, conventional longitudinals.

= 100, transverse stiffeners.

$P_{sl}$  : slamming pressure, defined in **Ch 2, 301**.

$\sigma_{sl}$  : allowable stress,  $180/K_a$

6. The shear area of longitudinals or transverse stiffeners supporting the bottom plating is not to be less than that obtained from the following formula :

$$A_S = \frac{6.7 P_{sl} (l - S) S}{\tau_{sl}} \quad (\text{cm}^3) \quad (2020)$$

$\tau_{sl}$  : allowable stress,  $90/K_a$

$S$  : spacing of stiffeners (m).

$P_{sl}$  : as defined in **Par 5**.

## Section 7 Transverses and Girders

### 701. Applications

1. The scantling and arrangements of transverses and girders, not mentioned in this section, are to be in accordance with **Ch 3, Sec 7**.
2. Direct strength calculation of transverses is to be determined at the discretion of the Society.

### 702. Minimum thickness (2020)

The thickness of structures is normally not to be less than that obtained from the following formula :

$$t = (t_o + kL)\sqrt{K} \frac{S}{S_R} \quad (\text{mm})$$

$S$  : actual stiffener spacing (m).

$S_R$  : basic stiffener spacing, as following formula.

$$S_R = 0.002(100 + L) \quad (\text{m})$$

$S/S_r$  is not to be taken less than 0.5 or greater than 1.0.

$t_o$  and  $k$  : as defined in **Table 3.4.6**.

### 703. Allowable stresses

Maximum allowable bending stresses in transverses and girders are to be in accordance with **Table 3.4.7**.

**Table 3.4.6 Values of  $t_o$  and  $k$**

Structures		$t_o$	$k$
Girders and Stiffeners	Bottom center girder	3.0	0.05
	Bottom side girders, floors, brackets and stiffeners	3.0	0.03
	Side, deck and bulkhead longitudinal girders and stiffeners outside the peaks	3.0	0.02
	Peak girders and stiffeners	3.0	0.03
	Longitudinals	3.0	0.03
	Double bottom floors and girders	3.0	0.02
Other structures	Foundations	3.0	0.08
	Structures not mentioned above	3.0	0.0

**Table 3.4.7 Allowable Stresses ( $\sigma$ )**

	Transverses and girders		
	Bending stresses (N/mm <sup>2</sup> )	Shear stresses (N/mm <sup>2</sup> )	Equivalent stresses (N/mm <sup>2</sup> )
Dynamic load	180/ $K$	90/ $K$	200/ $K$
Sea/static load	160/ $K$	90/ $K$	180/ $K$
Watertight bulkhead (excl. collision bulkhead)	200/ $K$	100/ $K$	220/ $K$



### 704. Effective breadth

The effective breadth is to be in accordance with **Ch 3, 601, Par 2.**

### 705. Strength requirements

1. The section modulus of girders subjected to lateral pressure is not to be less than that obtained from the following formula :

$$Z = \frac{mPl^2b}{\sigma} \quad (\text{cm}^3)$$

$\sigma$  : 160/ $K$  (N/mm<sup>2</sup>).

$b$  : breadth of load area (m), defined in **Table 3.4.8.**

$m$  : bending moment factor, defined in Table 3.4.10, for load and boundary conditions, and for not defined in previous Tables,  $m$ -values are directly from Table 3.4.9 and general elastic bending theory. (2020)

$l$  : Girder span

**Table 3.4.8 Breadth of Load Area ( $b$ )**

	$b$
For ordinary girders	$0.5(l_1 + l_2)$ (m)
For hatch side coamings	$2(B_1 - b_2)$ (m)
For hatch end beams	$0.4 b_3$ (m)
NOTE: $l_1$ and $l_2$ = the span (m) of the supported stiffeners. $B_1$ = breadth of craft (m) measured at the middle of hatchway. $b_2$ = breadth of hatch (m) measured at the middle of hatchway. $b_3$ = distance (m) between hatch end beam and nearest deep transverse girder or transverse bulkhead.	

2. The effective web area of girders subjected to lateral pressure is not to be less than that obtained from the following formula :

$$A_w = \frac{10(k_s l b P - ar)}{\tau} \quad (\text{cm}^2)$$

$k_s$  : shear force factor, defined in **Table 3.4.9** and **3.4.10.**

$a$  : number of stiffeners between considered section and nearest support, however, the  $a$ -value is in no case to be taken greater than  $(n+1)/4$ .

$l$  : Girder span

$n$  : number of supported stiffeners on the girder span, however, the web area at the middle of the span is not to be less than  $0.5 A_w$ .

$r$  : average point load (kN) from stiffeners between considered section and nearest support.

$\tau$  : allowable stress (N/mm<sup>2</sup>),  $90/Ka$ .

3. The equivalent stress is not to be exceed  $180/K$ .

### 4. Tripping brackets

The tripping brackets are to be in accordance with requirements in **Ch 3, 711.**

5. Girder web stiffeners

The girder web stiffeners are to be in accordance with requirements in **Ch 3, 712**.

**Table 3.4.9** Values of  $m$  and  $k_s$

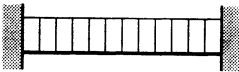
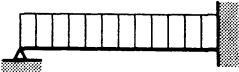
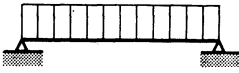
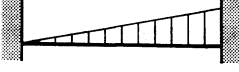
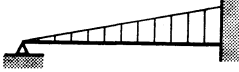
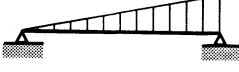
Load and boundary conditions			Boundary moment and shear force factors		
Positions			1	2	3
1 Support	2 Field	3 Support	$m_1$ $k_{s1}$	$m_2$ -	$m_3$ $k_{s3}$
			85 0.50	42	85 0.50
			0.38	70	125 0.63
			0.50	125	0.50
			65 0.30	43	100 0.70
			0.20	60	135 0.80
			0.33	130	0.67

**Table 3.4.10** Factors  $m$  and  $k_s$

		$m$	$k_s$
Bottom	Transverses	100	0.63
	Floors		
	Longitudinal girders		
Side	Longitudinal girders	100	0.54
	Transverses, upper end		0.54
	Transverses, lower end		0.72
	Deck girders		0.63
Bulkhead	Horizontal girders	100	0.54
	Vertical girders, upper end		0.54
	Vertical girders, lower end		0.72

**Section 8 Pillars**

**801. Applications**

The arrangement of pillars, supporting to transverses, girders and pillars, is in accordance with requirements in **Ch 3, Sec 8**. ↓

## CHAPTER 5 STRUCTURE PRINCIPLES IN FRP

### Section 1 General

#### 101. Application

1. The rules in this chapter apply to ships to be registered in accordance with the Regulations for the Classification and Registry of Ships, less than 60 m in length, of fibre reinforced plastics (FRP) single skin and sandwich constructions for assignment of the main structures. Upon special consideration other fiber reinforced plastics than FRP may be accepted. The ships of 60 m or more in length shall be determined at the discretion of this Society. **【See Guidance】**
2. The requirements, not mentioned in this chapter, are to be in accordance with requirements in **Ch 3** and **4**.

#### 102. Definitions

The definitions, except not defined in this chapter, are to be in accordance with following provisions.

- (1) Fibreglass reinforcement  
The fibreglass reinforcements are glass chopped strand mat (chopped mats), glass roving cloths (roving cloths) and glass roving (roving) of reinforcements for FRP manufactured from long fibres.
- (2) Resins  
The resins are liquid unsaturated polyester resins for laminating and gelcoat.
- (3) Blending proportion  
The blending proportion is a ratio in weight of the applied sclerotic and accelerator to the resin.
- (4) Laminating  
Laminating is an operation of laying succeeding glass fibre reinforcement impregnated with resin before curing or before the preceding layer advances in cure.
- (5) Bonding  
Bonding is an operation of connecting the FRP already advanced in cure with other FRP members, timbers, hard plastic foams, etc. by means of impregnating fibreglass reinforcements with resin.
- (6) Moulding  
Moulding is an operation of manufacturing FRP products with definite form, strength, etc. by means of laminating or bonding.
- (7) Single skin construction  
The single skin construction is a construction composed of FRP single panels moulded with fibreglass reinforcement and resin.
- (8) Sandwich construction  
The sandwich construction is a construction having FRP layers adhered to the both sides of core materials such as hard plastic form, balsa, timber (including plywood), etc.
- (9) Hand Lay-up Process  
The hand lay-up process is a method of manual moulding by impregnating fibreglass reinforcements with resin.

#### 103. Symbols

The symbols, used in **Sec 4** to **Sec 7**, are to be in accordance with follows.

- $t$  : laminate thickness (mm).  
 $t_c$  : sandwich core thickness (mm).  
 $d_f$  : distance (mm) between centerlines of opposite skin laminates of a sandwich panel.  
 $E$  : tensile or compressive modulus of elasticity of FRP laminate (N/mm<sup>2</sup>).  
 $E_c$  : modulus of elasticity of core material given on type approval certificate (N/mm<sup>2</sup>).  
 $G_c$  : modulus of rigidity of sandwich core material given on type approval certificate.  
 $\sigma_{nu}$  : ultimate normal stress in tension or compression of FRP laminate (N/mm<sup>2</sup>).  
 $\sigma_n$  : normal stress in FRP laminate (N/mm<sup>2</sup>).

- $\sigma_c$  : combined bending and membrane stress (N/mm<sup>2</sup>).  
 $\tau$  : shear stress in FRP laminate (N/mm<sup>2</sup>).  
 $\tau_u$  : ultimate shear stress of sandwich core material given on type approval certificate (N/mm<sup>2</sup>).  
 $\tau_c$  : core shear stress in laterally loaded sandwich panel (N/mm<sup>2</sup>).  
 $\omega$  : panel deflection (mm).  
 $\delta$  : panel deflection factor.  
 $\nu$  : Poisson's ratio.  
 $P$  : design pressure (kN/m<sup>2</sup>), defined in **Ch 2**.  
 $a$  : longest side of sandwich or single skin panel (m).  
 $b$  : shortest side of sandwich or single skin panel (m).

#### 104. Structural calculation

- To determine stresses and deflections in FRP single skin and sandwich construction either direct calculations using the full stiffness and strength properties of the laminate in all directions or a simplified method in accordance with **Sec 5 to 7** in this chapter will be accepted. However, direct calculation is to be in accordance with the discretion of the Society.
- The simplified method may be employed on the following conditions.
  - The principal directions of the laminate reinforcement is parallel to the panel edges.
  - The difference in elastic modulus in the two principal directions is not more than 20 %.
  - The skin laminates of sandwich panels are thin, i.e.  $d_f/t$  is greater than 5.77.

#### 105. Weight of fibreglass reinforcement and thickness of laminates

- The thickness of laminates per ply of chopped mats or roving cloths may be as obtained from the following formula.

$$t = \frac{W_G}{10 \gamma_R G} + \frac{W_G}{1000 \gamma_G} - \frac{W_G}{1000 \gamma_R} \quad (\text{mm})$$

- $W_G$  : designed weight per unit area of chopped mats or roving cloths (g/m<sup>2</sup>).  
 $G$  : glass content of laminate (ratio in weight) (%).  
 $\gamma_R$  : specific gravity of cured resin.  
 $\gamma_G$  : specific gravity of chopped mats or roving cloths.

- The glass content ( $G$ ) specified in the preceding **Par 1** is preferable to be the value per ply for the actual laminates. However, it may be taken as the mean glass content of the whole laminates.
- The specific gravity of chopped mats or roving cloths ( $\gamma_G$ ) specified in the preceding **Par 1** may be taken as 2.5 in calculation of the thickness, if nothing specially intervenes.
- The specific gravity of cured resin ( $\gamma_R$ ) specified in the preceding **Par 1** may be taken as 1.2 in calculation of the thickness, unless any fillers are used in order to make the resin heavier.
- Calculation of the thickness of laminates with fibreglass reinforcements other than chopped mats and roving cloths is to be in accordance with the discretion of the Society.

## 106. Bottom structures

### 1. Longitudinal stiffeners

- (1) Single bottoms as well as double bottoms are normally to be longitudinally stiffened in craft built in single skin construction. In craft with sandwich construction the bottom panel stiffening will be considered in each individual case.
- (2) The longitudinals should preferably be continuous through transverse members. At their ends longitudinals are to be fitted with brackets or to be tapered out beyond the point of support.
- (3) Longitudinal stiffeners are to be supported by bulkheads and/or transverse.

### 2. Transverses

- (1) Transverses are to be continuous around the cross section of craft i.e. web and flange laminates of floors, side webs and deck beams are to be efficiently connected together. If intermediate floors are fitted their ends should be well tapered or connected to local panel stiffening.
- (2) In the engine room, floors are to be fitted at every frame. The floors are preferably to be carried continuously through the engine girders. In way of thrust bearings additional strengthening is to be provided.

### 3. Longitudinal girders

- (1) Longitudinal girders are to be carried continuously through bulkheads. In craft built in sandwich construction longitudinal girders are to be fitted to support the bottom panels.
- (2) A center girder is to be fitted for docking purpose if the external keel or bottom shape does not give sufficient strength and stiffness.
- (3) Openings should not be located at ends of girders without due consideration being taken to shear loadings.

### 4. Engine girders

Main engines are to be supported by longitudinal girders with suitable local reinforcement to take the engine and gear mounting bolts. Rigid core materials to be applied in all through bolt connections.

### 5. Double bottom

Manholes are to be made in the inner bottom, floors and longitudinal girders to provide access to all parts of the double bottom. The vertical extension of openings is not to exceed one half of the girder height. Exposed edges of openings in sandwich constructions are to be sealed with resin impregnated mat. All openings are to have well rounded corners.

### 6. Bow impact protection

- (1) Crafts built in sandwich construction are to have the fore stem designed so that a local impact at or below the load line will not result in skin laminate peeling due to hydraulic pressure.
- (2) To comply with the requirement in preceding (1) outer and inner skin laminate of the hull panel shall be connected together as shown in **Fig 3.5.1**. The distance ( $a$ ) shall not less than following formula. The vertical extension of the collision protection shall be from the keel to a point  $0.03 L$  ( $m$ ) above the load line at operating speed.

$$a = 0.15 + \frac{1.5 V^2 \Delta}{10^6} \quad (\text{m})$$

- (3) The connection of the skin laminates shall be arranged in such a way that laminate peeling is effectively arrested (refer to, **Fig 3.5.2**).
- (4) Other arrangements giving an equivalent safety against laminate peeling may be accepted based on considerations in each individual case.
- (5) Within the vertical extension of the collision protection the stem laminate shall be increased to a thickness not less than that obtained from the following formula :

$$t_s = \frac{7 + (0.1 V)^{1.5}}{\sqrt{\frac{\sigma_{nu}}{160}}} \quad (\text{mm})$$

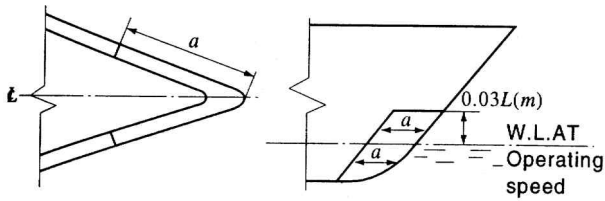

Fig 3.5.1 Collision protection

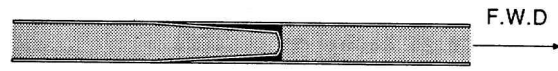

Fig 3.5.2 Laminate connection

### 107. Deck structure

1. Decks of single skin construction are normally to be longitudinally stiffened.
2. The longitudinals should preferably be continuous through transverse members. At their ends longitudinals are to be fitted with brackets or to be tapered out beyond the point of support.
3. The laminate thickness of single skin constructions is to be such that the necessary transverse buckling strength is achieved, or transverse intermediate stiffeners may have to be fitted.

### 108. Bulwarks

1. Bulwark sides are to have the same scantlings as required for a superstructure in the same position.
2. A strong flange is to be made along the upper edge of the bulwark. Bulwark stays are to be arranged in line with transverse beams or local stiffening. The stays are to have sufficient width at deck level. If the deck is of sandwich construction solid core inserts are to be fitted at the foot of the bulwark stays. Stays of increased strength are to be fitted at ends of bulwark openings. Openings in bulwarks should not be situated near the ends of superstructures.
3. Where bulwarks on exposed decks form wells, ample provision is to be made to facilitate freeing the decks from water.

### 109. Bulkhead structures

#### 1. Watertight bulkheads

The number and location of watertight bulkheads are to be in accordance with requirements in **Ch 1, Sec 4**.

#### 2. Supporting bulkheads

Bulkheads supporting decks are to be regarded as pillars. The buckling strength is to be considered in each individual case.

## Section 2 Materials

### 201. Application

1. The hull, constructed in FRP, is to be in accordance with requirements in this section. The requirements, not mentioned in this section, are to be in accordance with the **Rules for the Classification of FRP Ships**.
2. Reinforcement, matrix, fillers and core materials for major hull structural elements are normally to be approved by Society.
3. The polyester containing wax or other material that deteriorate bonding are to be carried out inter-laminar shear strength test (KS M ISO 14130) and approved by the Society.

## 202. Equivalency

The type approval of FRP materials, not mentioned in this section, is in accordance with official standard. Alternative FRP material will be accepted by the Society, provided that the Society is satisfied that such material is equivalent to those required in this rules.

## 203. Application of materials

1. Grade 1 polyester is to be used for the hull shell laminate in single skin construction and for the outer hull skin laminate in sandwich construction.
2. The outer reinforcement ply of the outer hull skin laminate is to be at least 450 g/m<sup>2</sup> of chopped strand fibres containing as little water soluble bonding components as possible. Normally spray roving or powder bound mat should be used. Alternatively a 300 g/m<sup>2</sup> mat and a light surface mat can be used. Other material systems giving an equivalent surface protection may also be accepted.
3. Areas inside the hull expected to be continuously exposed to water submersion (i. e. bilge wells etc.) and the inside of tanks shall have a surface lining consisting of at least 600 g/m<sup>2</sup> reinforcement material.
4. The strength calculations are to be based on mechanical properties obtained from testing of representative sandwich panels and laminates with respect to production procedure, workshop conditions, raw materials, lay-up sequence, etc.

# Section 3 Manufacturing

## 301. Application

The hull structure, constructed in FRP, is to be in accordance with requirements in this chapter. The requirements, not mentioned in this chapter, are to be in accordance with requirements in the **Rules for the Classification of FRP Ships and Guidance for Approval of Manufacturing Process and Type Approval, ETC.**

## 302. Manufacturing conditions

### 1. Storage of raw materials

- (1) Storage premises are to be so equipped and arranged that the material supplier's directions for storage and handling of the raw materials can be followed.
- (2) Storage premises for glassfibre are to be kept clean and as free from dust as possible, so that the raw material is not contaminated. Glassfibre parcels are also to be protected against rain and moisture.
- (3) Polyester, gelcoat and the like should not be stored by temperatures that will affect the qualities of the material. Raw materials which are stored at temperatures lower than 18 °C should be heated up before use to the temperature of the moulding shop. Tanks for polyester are to be equipped and arranged so that the contents can be stirred every day.
- (4) The glassfibre material is, whenever possible, to be stored for at least two days in storage premises, with air of a lower relative humidity than in the manufacturing premises, and at an air temperature at least 2 °C higher than in the manufacturing premises. If such storage of the glassfibre material before transfer to the manufacturing is not possible, the material is to be stored for at least two days in premises with air of the same condition as in the moulding premises.
- (5) The storage temperature and the storage periods for resins and coating are to be within the limits specified by the material supplier.
- (6) Core materials are to be stored dry and protected against mechanical damages.

### 2. Manufacturing conditions

- (1) Manufacturing premises are to be so equipped and arranged that the material supplier's directions for handling the materials, the laminating process and curing conditions can be followed.
- (2) The air temperature in the moulding shops is not to be less than 18 °C. The stipulated minimum temperature is to be attained at least 24 hours before commencement of laminating, and is to

be maintainable regardless of the outdoor air temperature. The temperature in the moulding shops is not to vary by more than  $\pm 3^\circ\text{C}$  during 24 hours.

- (3) The relative humidity of the air is to be kept so constant that condensation is avoided and is not to exceed 80%. In areas where spray moulding is taking place, the humidity is not to be less than 40%. The stipulated air humidity is to be maintainable regardless of outdoor air temperature and humidity.
- (4) Air temperature and relative humidity are to be recorded regularly. In larger shops there is to be at least on thermohydrograph for each  $1500\text{ m}^2$  where lamination is carried out. The location of the instruments in the premises is to be as neutral as possible.
- (5) Draught through doors, windows etc. and direct sunlight is not acceptable in places where lamination and curing are in progress.
- (6) Manufacturing premises are to be kept clean and as free of dust as possible, so that raw materials and moulds are not contaminated.
- (7) The ventilation plant is to be so arranged that the curing process is not affected.
- (8) Sufficient scaffoldings are to be arranged so that all lamination work can be carried out without operators standing on the core or on surfaces on which lamination work is taking place.
- (9) During lamination of large constructions the temperature should be recorded at least at two levels vertically in the workshop and the curing system should be adjusted to compensate for possible temperature differences.
- (10) Fabrication of flat panels are to be carried out on a support lifted from the workshop floor level.

### 303. Production procedures and workmanship

#### 1. Sandwich lay-up

- (1) Efficient bond is to be obtained between the skin laminates and the core and between the individual core elements. Approved tools for cutting, grinding etc. of various types of core material shall be specified in the production procedure. The bond is to be verified by shear or tensile testing.
- (2) All joints between skin laminates and core and between the individual core elements are to be completely filled with resin, glue or filler material.
- (3) Core materials with open cells in the surface, should normally be impregnated with resin before it is applied to a wet laminate or before lamination on the core is commenced.
- (4) When the core is applied manually to a wet laminate the surface shall be reinforced with a chopped strand mat of  $450\text{ g/m}^2$  in plane surface and  $600\text{ g/m}^2$  in curved surface. If vacuum is applied for core bonding the reinforcement type in the laminate surface will be considered in each individual case.
- (5) When a prefabricated skin laminate is glued to a sandwich core measures are to be taken to evacuate air from the surface between skin and core.
- (6) The core material is to be free from dust and other contaminations before the skin laminates are applied or core elements are glued together.

#### 2. Manual lamination

- (1) When the laminate is applied in a mould a chopped strand mat of maximum  $450\text{ g/m}^2$  is to be applied next to the gelcoat.
- (2) The time interval between applications of each layer of reinforcement is to be within the limits specified by the material supplier. For thicker laminates care is to be taken to ensure a time interval sufficiently large to avoid excessive heat generation.
- (3) Curing systems are to be selected with due regard to the reactivity of the polyester and in accordance with the supplier's directions. Heat development during curing is to be kept at a safe level. The quantity of curing agents is to be kept within the limits specified by the supplier.
- (4) The reinforcement next to the core is normally to be a chopped strand mat of at least  $300\text{ g/m}^2$ . A lighter mat may be accepted provided proper bond is documented by testing.

#### 3. Secondary bonding

- (1) If a laminate subject to secondary bonding has cured for more than 5 days the surface should be ground. If resin containing wax is used grinding is required if the curing time exceeds 24 hours.
- (2) If peel strips are used in the bonding surface the required surface treatment may be dispensed with.



## Section 4 Hull Girder Strength

### 401. General

1. The requirements, not mentioned in following Par. are to be in accordance with requirements in **Ch 3, Sec 4**
2. When calculating the section modulus of a composite structure possible differences in the elasticity modulus of various structural members are to be taken into account. The stresses are to be corrected accordingly.

### 402. Deck corners

Moulded deck line, rounded sheer strake, sheer strake and stringer plate are as defined in **Fig 3.5.3**.

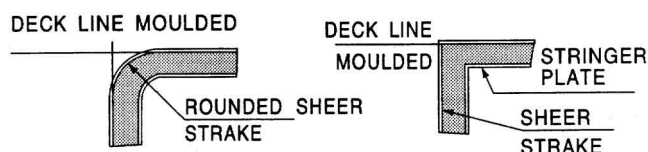

Fig 3.5.3 Deck corners

### 403. Vertical bending strength

The vertical bending stresses of FRP craft are in accordance with requirements in **Ch 3** and s-values are defined as follows.

$$\sigma = 0.3 \sigma_{nu} \text{ (N/mm}^2\text{)} \quad : \text{ In general.}$$

$$\sigma = 0.27 \sigma_{nu} \text{ (N/mm}^2\text{)} \quad : \text{ For hydrofoil on foils.}$$

$$\sigma = 0.24 \sigma_{nu} \text{ (N/mm}^2\text{)} \quad : \text{ In slowed-down condition for planing craft.}$$

### 404. Allowable strength

1. If direct calculation using the full stiffness and strength properties of the laminate are carried out the procedure is to be followed by Society approval.
2. When a simplified calculation method is used for constructions complying with **104. Par 2** the total normal stresses in the two main directions shall comply with the requirements of **503. Par 5, 603. Par 3** and **604. Par 1**. However, in plane laminate shear stresses shall be less than 0.25 times of ultimate shear stress.

## Section 5 Sandwich Panels

### 501. Consideration of buckling

Buckling strength of sandwich panels related to longitudinal hull girder strength or local axial loads are to be dealt with individually.

### 502. Minimum requirements to structural sandwich panels

1. The reinforcement of skin laminates is to contain at least 40 % continuous fibres.
2. The mechanical properties of the core material of structural sandwich panels are to comply with the following minimum requirements (refer to **Table 3.5.1**).

**Table 3.5.1 Mechanical Properties of Sandwich Panels**

Structural members	Core properties (N/mm <sup>2</sup> )	
	Shear strength	Compression strength
Hull bottom, side and transom below deepest WL or chine whichever is higher	0.8	0.9
Hull side and transom above deepest WL or chine whichever is higher	0.8	0.9
Weather deck not intended for cargo	0.5	0.6
Cargo deck	0.8	0.9
Accommodation deck	0.5	0.6
Structural/watertight bulkheads/double bottom	0.5	0.6
Superstructures/Deckhouses	0.5	0.6
Tank bulkheads	0.5	0.6

3. The mass of reinforcement (g/m<sup>2</sup>) in skin laminates in structural sandwich panels should normally not be less than the following. However, Details including laminating process such as work sheets to be submitted.

$$W \geq W_0(1+k(L-20)) \quad \text{for } L > 20\text{m}$$

$$W = W_0 \quad \text{for } L \leq 20\text{m}$$

$W$  : mass of reinforcement per unit area, (g/m<sup>2</sup>)

$W_0$  : given in **Table 3.5.2** (For mixed material reinforcements  $W_0$  can be found by linear interpolation in the table according to the relative percentage of each material with respect to weight per unit area.)

$k$  : given in **Table 3.5.2**.

$L$  : length between perpendiculars.

4. Deviation from the minimum requirements may be accepted by the Society on consideration of craft type and service restriction or based on documentation of equivalent resistance to loads described in **Table 3.5.1**.

Table 3.5.2  $W_o$  and  $k$

Structural Member	$W_o$ (g/m <sup>2</sup> )		$k$
	Glass	Carbon/Aramid	
Hull bottom, side and transom below deepest WL or chine whichever is higher	2400	1600	0.025
Hull side and transom above deepest WL or chine whichever is higher	1600	1100	0.025
Hull bottom and side, inside of hull	1600	1100	0.013
Stem and keel, (width to be defined)	6000	4000	0.025
Weather deck (not for cargo)	1600	1100	0.0
Wet deck	1600	1100	0.0
Cargo deck	3000	2000	0.013
Accommodation deck, if adequately protected	1200	800	0.0
Accommodation deck, other	1600	1100	0.0
Decks, underside skin	750	500	0.0
Deep tank bulkheads/double bottom	1600	1100	0.0
Structural bulkheads	1200	800	0.0
Watertight bulkheads	1600	1100	0.0
Superstructure and deckhouse, outside	1200	800	0.013
Inside void spaces without normal access	750	500	0.0

### 503. Bending

#### 1. Normal stresses in skin laminates and core shear stresses

- (1) Maximum normal stresses in the skin laminates of a sandwich panel subject to uniform lateral pressure is given by the following formula :

$$\sigma_n = \frac{160 P b^2}{W} C_N C_1 \quad (\text{N/mm}^2)$$

$C_N = C_2 + \nu C_3$  : For stresses parallel to the longest edge, refer to **Fig 3.5.4**.

$C_N = C_3 + \nu C_2$  : For stresses parallel to the shortest edge, refer to **Fig 3.5.4**.

$W$  : section modulus of the sandwich panel per unit breadth (mm<sup>3</sup>/mm). For a sandwich panel with skins of equal thickness  $W = d_i$

$C_1$  : factor, as defined in follows.

= 1.0, for panels with simply supported edges.

=  $C_{1L}$  or  $C_{1S}$  according to **Fig 3.5.5**, for panels with fixed edges or partially fixed edges.  $C_{1L}$  for stresses parallel to the longest edge.  $C_{1S}$  for stresses parallel to shortest edge.

- (2) The maximum core shear stresses at the midpoints of the panel edges of a sandwich panel subject to lateral pressure is given by the following formula :

$$\tau_c = \frac{0.52 P b}{d_f} C_S \quad (\text{N/mm}^2)$$

$C_S = C_4$ , for core shear stress at midpoint of longest panel edge, see Fig 3.5.6.

$C_S = C_5$ , for core shear stress at midpoint of shortest panel edge, see Fig 3.5.6.

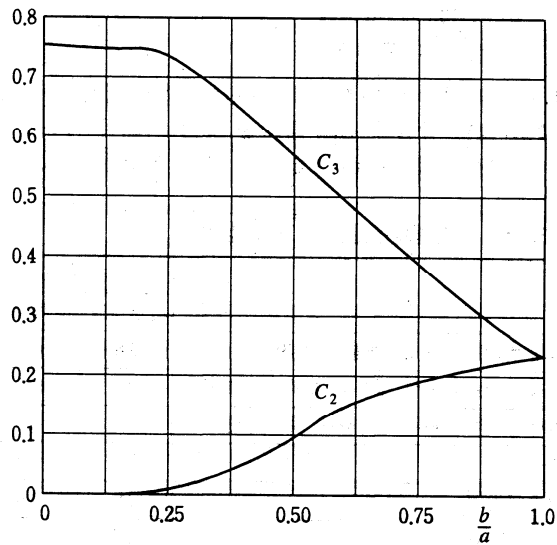

Fig 3.5.4 Factors  $C_2$  and  $C_3$

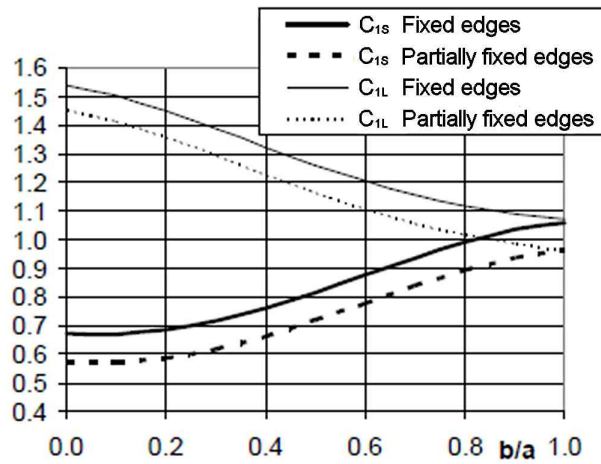

Fig 3.5.5 factor  $C_1$

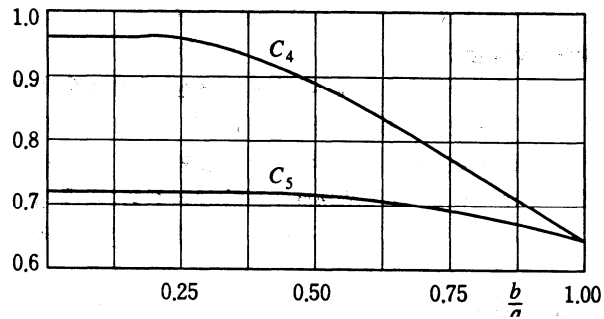

Fig 3.5.6 Factors  $C_4$  and  $C_5$

## 2. Local skin buckling

The critical local buckling stress for skin laminates exposed to compression is given by the following formula :

$$\sigma_{cr} = 0.5(E E_C G_C)^{\frac{1}{3}} \quad (\text{N/mm}^2)$$

## 3. Deflection

The deflection at the midpoint of a flat panel is given by the following formula :

$$w = \frac{10^6 P b^4}{D_2} (C_6 C_8 + \rho C_7) ,$$

$$\rho = \frac{\pi^2 D_2}{10^6 G_C d_f b^2}$$

$C_6$  and  $C_7$  : refer to **Table 3.5.7**.

$C_8$  : factor, as defined in follows.

= 1.0, panels with simply supported edges.

= refer to **Fig 3.5.8**, panels with fixed edges or partially fixed.

$D_2$  : modulus of elasticity, refer to **Table 3.5.3**.

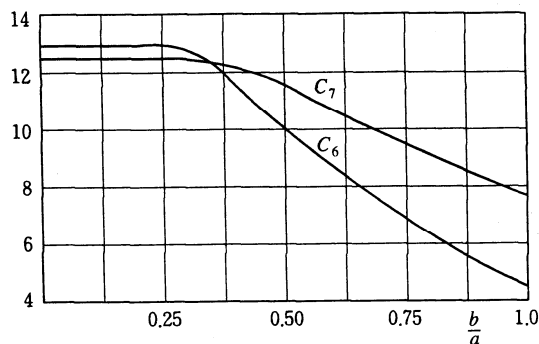

Fig 3.5.7 Factors  $C_6$  and  $C_7$

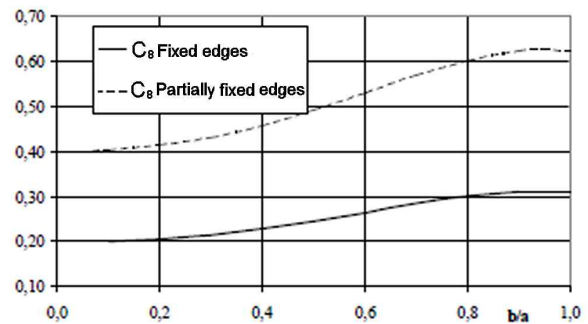

Fig 3.5.8 Factor  $C_8$

Table 3.5.3 Modulus of Elasticity

	$D_2$
For panels with skin laminates with equal thickness and modulus of elasticity	$\frac{E t d_f^2}{2(1-\nu^2)}$
For panels with skin laminates with different thickness and modulus of elasticity	$\frac{E_1 E_2 t_1 t_2 d_f^2}{(1-\nu^2)(E_1 t_1 + E_2 t_2)}$
NOTE : 1 and 2 : inner and outer skin respectively.	

## 4. Allowable stresses and deflections

The maximum normal stresses in skin laminates, core shear stresses and deflection are not to be greater than given values in following **Table 3.5.4**.

**Table 3.5.4 Allowable Stresses and Deflection**

Structural member	$\sigma_n$	$\tau_c$	$w/b$
Bottom panels exposed to slamming	$0.3 \sigma_{nu}^{(1)}$	$0.35 \tau_c^{(2)}$	0.01
Remaining bottom and inner bottom	$0.3 \sigma_{nu}$	$0.4 \tau_c$	0.01
Side structures	$0.3 \sigma_{nu}$	$0.4 \tau_c$	0.01
Deck structures	$0.3 \sigma_{nu}$	$0.4 \tau_c$	0.01
Bulkhead structures	$0.3 \sigma_{nu}$	$0.4 \tau_c$	0.01
Superstructures	$0.3 \sigma_{nu}$	$0.4 \tau_c$	0.01
Deckhouses	$0.3 \sigma_{nu}$	$0.4 \tau_c$	0.01
All structures exposed to long time static loads	$0.20 \sigma_{nu}$	$0.15 \tau_c$	0.005
<p>NOTE:</p> <p>(1) <math>\sigma_{nu}</math> is to be in accordance with the following :  For skin laminates exposed to tensile stress : ultimate tensile stress.  For skin laminates exposed to compressive stress :the smaller of the ultimate compressive stress and critical local buckling stress.</p> <p>(2) The allowable stress level for bottom panels exposed to slamming loads refer to core materials with a shear elongation of at least 20 % an increase of the allowable stress level may be accepted upon special consideration.</p>			

## Section 6 Single Skin Construction

### 601. Consideration of buckling

Buckling strength of single skin panels subjected to longitudinal hull girder strength or local compressional loads will be dealt with individually.

### 602. Minimum requirements to structural single skin plates

1. The reinforcement of single skin laminates is to contain at least 40 % continuous fibres.
2. The mass of reinforcement ( $\text{g/m}^2$ ) in single skin panel should normally not be less than following: However, details including laminating process such as work sheets to be submitted.

$$W \geq W_0(1+k(L-20)) \quad \text{for } L > 20\text{m}$$

$$W = W_0 \quad \text{for } L \leq 20\text{m}$$

$W$  : mass of reinforcement per unit area,  $\text{g/m}^2$

$W_0$  : given in **Table 3.5.5**. (For mixed material reinforcements  $W_0$  can be found by linear interpolation in the table according to the relative percentage of each material with respect to weight per unit area.)

$k$  : given in **Table 3.5.5**.

$L$  : length between perpendiculars.

**Table 3.5.5**  $W_o$  and  $k$

Item	$W_o$ (g/m <sup>2</sup> )	$k$
Hull bottom, side and transom below deepest WL or chine whichever is higher	4200	0.025
Hull side and transom above deepest WL or chine whichever is higher	4200	0.025
Stem and keel to 0.01 L from centreline	7500	0.025
Chine and transom corners to 0,01 L from chine edge	5800	0.025
Bottom aft in way of rudder, shaft braces, and shaft penetrations	6600	0.025
Weather deck not intended for cargo	4200	0.0
Cargo deck	5400	0.013
Accommodation deck	2900	0.0
Structural/watertight bulkheads/ double bottom	4200	0.0
Tank bulkheads	4500	0.0
Other bulkheads	2500	0.0
Superstructures and deckhouses	4200	0.013

### 603. Laterally loaded single skin laminates

#### 1. Assumptions

- (1) The formulas given below are valid under the following assumptions.
  - (A) The principal directions of reinforcement are parallel to the edges of the panel.
  - (B) The difference in the modulus of elasticity in the two principal direction of reinforcement is not more than 20 %.
  - (C) The load is uniformly distributed.
- (2) For laminates not complying with the above (1) are to be in accordance with the discretion of the Society.

#### 2. Laminates exposed to combined bending and membrane stresses.

- (1) For a given design pressure the thickness requirements are related to a laminate deflection factor  $d(=w/t)$  and an allowable combined stresses (bending stress + membrane stress).
- (2) The required thickness to meet a specific value of  $d$  in association with a given design pressure is given by the following formula :

$$t = 178 b \left( \frac{P}{\delta E (C_1 + \delta^2 C_2)} \right)^{\frac{1}{4}} \quad (\text{mm})$$

$C_1$  and  $C_2$  : refer to **Table 3.5.9**.

- (3) The combined stresses (bending stress + membrane stress) corresponding to the thickness found in (2) is given the following formula :

$$\sigma_c = \left( \frac{t}{1000 b} \right)^2 \delta E \left[ C_1 C_2 + C_4 (C_2^2)^{\frac{1}{3}} \right] \quad (\text{N/mm}^2)$$

$C_1$  and  $C_2$  : refer to **Fig 3.5.9**.

$C_3$  and  $C_4$  : refer to **Fig 3.5.10**.

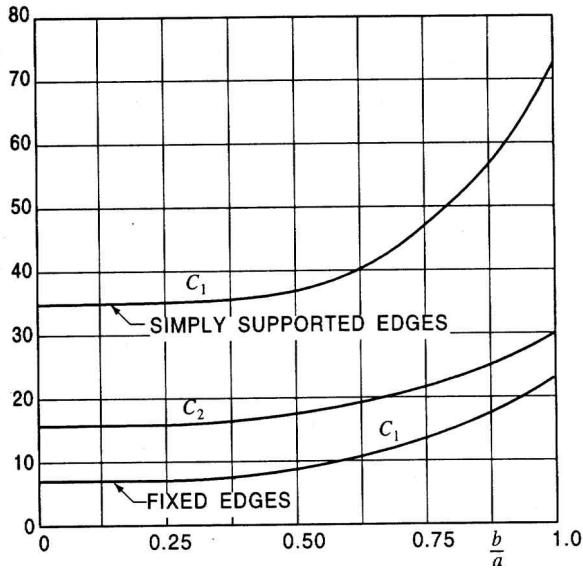

Fig 3.5.9 Factors  $C_1$  and  $C_2$

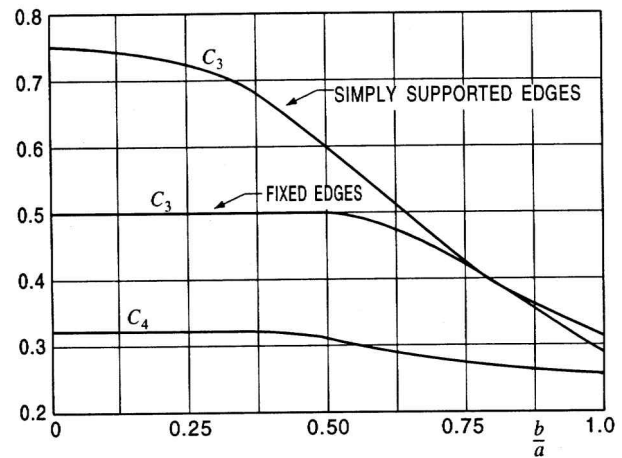

Fig 3.5.10 Factors  $C_3$  and  $C_4$

### 3. Allowable stresses and deflections

The maximum combined stresses (bending stress + membrane stress) and deflections are not to be greater than given values in the **Table 3.5.6**.

**Table 3.5.6 Allowable Stresses and Deflection**

Structural member	$\sigma_c$	$\delta$
Bottom panels exposed to slamming	$0.3 \sigma_{mu}$	1.0
Remaining bottom and inner bottom	$0.3 \sigma_{mu}$	0.9
Side structures	$0.3 \sigma_{mu}$	0.9
Deck structures	$0.3 \sigma_{mu}$	0.9
Bulkhead structures	$0.3 \sigma_{mu}$	0.9
Superstructures	$0.3 \sigma_{mu}$	0.9
Deckhouses	$0.3 \sigma_{mu}$	0.9
All structures exposed to long time static loads	$0.2 \sigma_{mu}$	0.5

## 604. Stiffeners

### 1. Section modulus

(1) The section modulus of longitudinals, beams, frames and other stiffeners subject to lateral pressure is not to be less than that obtained from the following formula :

$$Z = \frac{mPSl^2}{\sigma} \quad (\text{cm}^3)$$

$m$  : bending moment factor, defined in **Sec 7, Table 3.5.10** for load and boundary conditions, and **Table 3.5.8** for structural members.



- $S$  : spacing of stiffeners (m).  
 $l$  : span of the stiffeners (m).  
 $\sigma$  : allowable stress, defined in **Table 3.5.7**.

(2) When calculating the section modulus of top hat stiffeners the effect of possible variations in the modulus of elasticity through the section should be taken into account. Effective flange is to be determined in accordance with **704. Par 2**.

**Table 3.5.7 Allowable Stresses**

Structural member	$\sigma$
Bottom plates exposed to slamming	$0.25 \sigma_{nu}$
Remaining bottom and inner bottom	$0.25 \sigma_{nu}$
Side structures	$0.25 \sigma_{nu}$
Deck structures	$0.25 \sigma_{nu}$
Bulkhead structures	$0.25 \sigma_{nu}$
Superstructures	$0.25 \sigma_{nu}$
Deckhouses	$0.25 \sigma_{nu}$
All structures exposed to long time static loads	$0.15 \sigma_{nu}$

**Table 3.5.8 Bending Moment Factor ( $m$ )**

structures	$m$
Continuous longitudinal members	85
Non-continuous longitudinal members	100
Transverse members	100
Vertical members, and fixed	100
Vertical members, simply supported	135
Bottom longitudinal members	85
Bottom Transverse members	100
Side longitudinal members	85
Side vertical members	100
Deck longitudinal members	85
Deck Transverse members	100
W.T. bulkhead stiffeners, fixed ends	65
W.T. bulkhead stiffeners, fixed one end (lower)	85
W.T. bulkhead stiffeners, simply supported ends	125
Tank and cargo bulkhead, fixed ends	100
Tank and cargo bulkhead, simply supported ends	135
Deckhouse stiffeners	100
Casing stiffeners	100

## Section 7 Transverses and Girders

### 701. General

In this section, the general requirements for simple girders and procedures for the calculations of complex girder systems are given. The buckling strength of girders will be dealt with individually considered.

### 702. Symbols

In this chapter the symbols in formulas are as follows.

$S$  : girder span (m), the web height of in-plane girders may be deducted.

$b$  : breadth of load area (m), refer to **Table 3.5.9**.

$P$  : design pressure, defined in **Ch 2**.

$P_a$  : design axial force (kN).

$\sigma$  : nominal allowable bending stress due to lateral pressure (N/mm<sup>2</sup>).

$\tau$  : nominal allowable shear stress (N/mm<sup>2</sup>).

$\tau_b$  : nominal allowable bond shear stress (N/mm<sup>2</sup>).

$\tau_w$  : web thickness (mm).

$h_w$  : web height (mm).

$b_f$  : flange breadth (mm).

**Table 3.5.9 Breadth of Load Area**

	$b$
For ordinary girders	$0.5(l_1 + l_2)$ (m)
For hatch side coamings	$2(B_1 - b_2)$ (m)
For hatch end beams	$0.4b_3$ (m)
NOTE:	
$l_1$ and $l_2$ : the span (m) of the supported panels.	
$B_1$ : breadth of craft (m) measured at the middle of hatchway.	
$b_2$ : breadth of hatch (m) measured at the middle of hatchway.	
$b_3$ : distance (m) between hatch end beam and nearest deep transverse girder or transverse bulkhead.	

### 703. Continuity of strength members

1. Structural continuity is to be maintained at the junction of primary supporting members of unequal stiffness by fitting well rounded brackets. Brackets ending at unsupported sandwich panels are to be tapered smoothly to zero and the panels skin laminate to be locally reinforced at the end of the bracket. Girders are to be fitted with bracket or tapered to zero at their ends, (refer to, **Fig 3.5.11**).
2. Where practicable, deck pillars are to be located in line with pillars above or below. Massive or high density core inserts are to be fitted at the foot of pillars.
3. Below decks and platforms, strong transverses are to be fitted between verticals and pillars, so that rigid continuous frame structures are formed.

### 704. Bending and shear

#### 1. General

- (1) The requirements for section modulus and web area given in this chapter are applicable to simple girders supporting stiffeners or other girders exposed to linearly distributed lateral pressure. It is assumed that the girder satisfies the basic assumptions of simple beam theory and that the

supported members are approximately evenly spaced and simply supported at both ends. Other loads will have to be specially considered.

- (2) When boundary conditions for individual girders are not predictable due to dependance of adjacent structures, direct calculations according to the discretion of the Society will be required.

## 2. Effective breadth

The effective panel flange area is defined as **Fig 3.5.12**. For top-hat girders supporting sandwich panels only the skin laminate at which the girder is fitted should be considered as effective breadth.

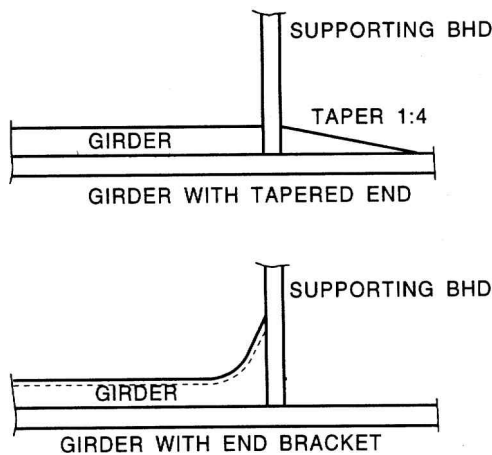
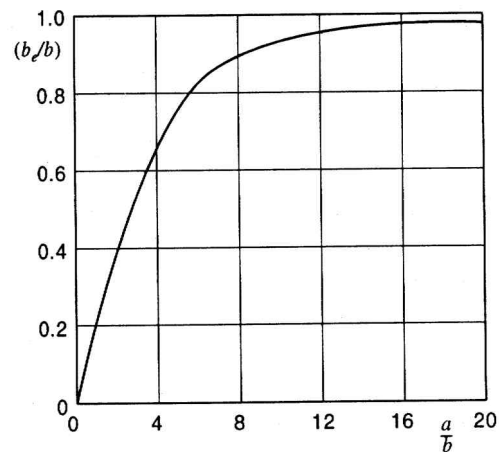

Fig 3.5.11 Ends of Girders



$a$  is the distance between points of zero bonding moments.

For simply supported girder  $S$ :

For girders fixed at both ends  $0.6 S$ .

Fig 3.5.12 Effective Breadth ( $b_e$ )

## 3. Effective web

- (1) Holes in girders will generally be accepted provided the shear stress level is acceptable and the buckling strength is sufficient. Holes are to be kept well clear of end of brackets and locations where shear stresses are high.
- (2) For ordinary girder cross-sections the effective web area is to be taken as following formula :

$$A_w = 0.01 h_n t_w \quad (\text{cm}^2)$$

$h_n$  : net girder height (mm), after deduction of cutouts in the cross-section considered. If an opening is located at a distance less than  $h/3$  from the cross-section considered,  $h_n$  is to taken as the smaller of the net height and the net distance through the opening, refer to **Fig 3.5.13**.

- (3) Where the girder flange is not perpendicular to the considered cross section in the girder, the effective web area is to be taken as following formula, refer to **Fig 3.5.14**.

$$A_w = 0.01 h_n t_w + 1.3 A_{FL} \sin 2\theta \sin \theta \quad (\text{cm}^2)$$

$h_n$  : as defined in previous (2).

$A_{FL}$  : flange area ( $\text{cm}^2$ ).

$\theta$  : angle of slope of continuous flange.

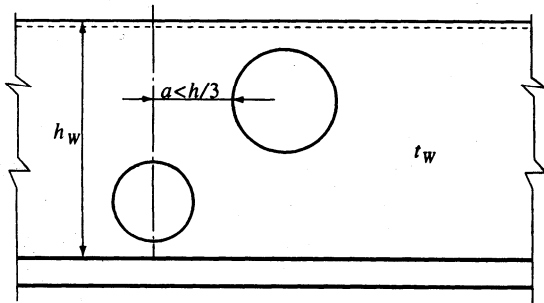

Fig 3.5.13 Effective Web Area in Way of Openings

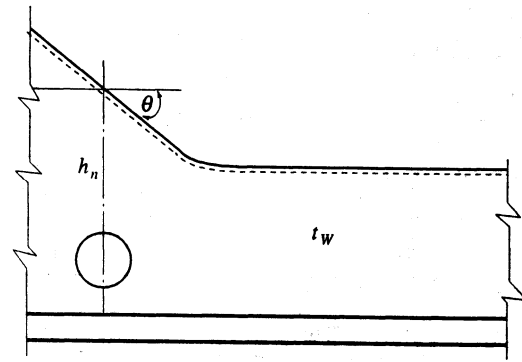

Fig 3.5.14 Effective Web Area in Way of Brackets

#### 4. Effective bond area

For girders attached to other structural members at their supports by secondary bonding the effective bond area is determined by the following formula, (refer to Fig 3.5.15).

$$A_B = BH - bh \quad (\text{cm}^2)$$

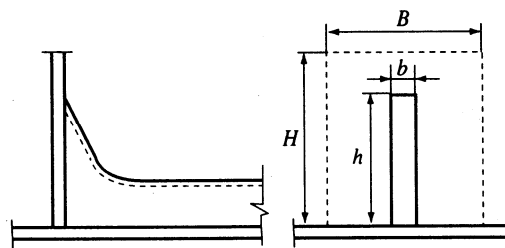

Fig 3.5.15 Effective Bond Area

#### 5. Scantlings of girders

(1) The section modulus for girders subjected to lateral pressure is not to be less than that obtained from the following formula :

$$Z = \frac{mPbS^2}{\sigma} \quad (\text{cm}^3)$$

$m$  : bending moment factor, defined in (5).

$$\sigma = 0.21\sigma_u$$

When calculating the section modulus of top hat profiles the effect of possible variations in the modulus of elasticity throughout the section should be taken into account.

(2) The web area of girders subject to lateral pressure is not to be less than that obtained from the following formula :

$$A_W = \frac{10k_s P_a b S}{\tau} \quad (\text{cm}^2)$$

$k_s$  : shear force factor, defined in (4).

$$\tau = 0.25\tau_u$$

- (3) The bond area, between girders and their supporting structure, at the girders ends is not to be less than that obtained from the following formula :

$$A_B = \frac{10k_s P_d b S}{\tau_b} \quad (\text{cm}^2)$$

$k_s$  : shear force factor, defined in (4).

$$\tau_b = 0.25 \tau_u$$

$\tau_{bu}$  : the ultimate bond shear stress for the secondary bonding.

- (4) The  $m$  and  $k_s$  values are given for some defined load and boundary conditions in **Table 3.5.10**, not defined in previous Table,  $m$ -values are directly from general elastic bending theory. For girders where brackets are fitted or the flange area has been partly increased due to large bending moment, a larger  $m$ -value may be accepted outside the strengthened region.
- (5) The  $m$  and  $k_s$  values referred to in (1) and (2) are normally to be as **Table 3.5.11** for the various structural members. ↓

**Table 3.5.10** Values of  $m$  and  $k_s$

Load and boundary conditions			Boundary moment and shear force factors		
Positions			1	2	3
1 Support	2 Field	3 Support	$m_1$ $k_{s1}$	$m_2$ -	$m_3$ $k_{s3}$
			85 0.50	42	85 0.50
			0.38	70	125 0.63
			0.50	125	0.05
			65 0.30	43	100 0.70
			0.20	60	135 0.80
			0.33	130	0.67

Table 3.5.11 Factors  $m$  and  $k_s$

		$m$	$k_s$
Bottom	Transverses	100	0.63
	Floors	100	
	Longitudinal girders	100	
Side	Longitudinal girders	100	0.54
	Transverses, upper end	100	0.54
	Transverses, lower end	100	0.72
	Deck girders	100	0.63
Bulkhead	Horizontal girders	100	0.54
	Vertical girders, upper end	100	0.54
	Vertical girders, lower end	100	0.72

**PART 4**  
**HULL EQUIPMENT**

## CHAPTER 1 RUDDERS

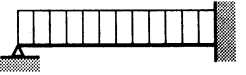
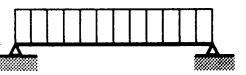
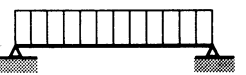
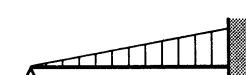
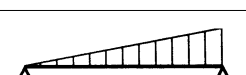
### Section 1 General

#### 101. Application

1. The requirements in this chapter apply to single plate rudders and double plate rudders of stream line section and ordinary shape, rudders having no bearing below the neck bearing, (refer to **Fig 4.1.1**).
2. Rudder other than those specified in **Par 1**, are to comply with the requirement in **Pt 4, Ch 1. of Rules for the Classification of Steel Ships**.
3. Requirements not specified in this chapter are to comply with the requirements in **Pt 4, Ch 1. of Rules for the Classification of Steel Ships**.

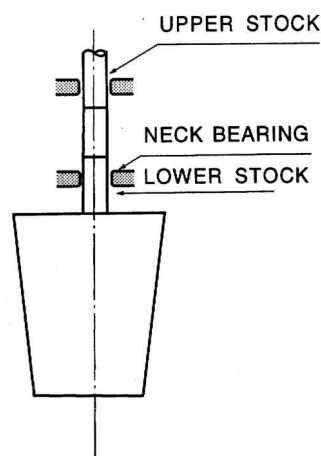

Fig 4.1.1 Spade rudder

#### 102. Materials

1. Rudders stocks, coupling bolts, keys and cast parts of rudders are to be made of rolled steel, steel forging or carbon steel casting, conforming to the requirements in **Pt 2, Ch 1. of Rules for the Classification of Steel Ships**. For rudder stocks, coupling bolts and keys, the minimum yield stress is not to be less than  $200 \text{ (N/mm}^2\text{)}$ . The requirements in this chapter are based on a material's yield stress of  $235 \text{ (N/mm}^2\text{)}$ . If material is used having a yield stress differing from  $235 \text{ (N/mm}^2\text{)}$  the material factor,  $K$  is to be determined according to **Table 4.1.1**.
2. When the rudder stock diameter is reduced by the application of steels with yield stresses exceeding  $235 \text{ (N/mm}^2\text{)}$ , special consideration is to be given to deformation of the rudder stock to avoid excessive pressures at the edges of bearings.
3. Welded members of rudders such as rudder plates, rudder frames, rudder main pieces, and edge bars are to be made of rolled steel for hull conforming to the requirements in **Pt 2, Ch 1. of Rules for the Classification of Steel Ships**. The required scantlings may be reduced when high tensile steels are applied. When reducing the scantling, the material factor  $K$  is to be as in **Table 4.1.2**.



**Table 4.1.1 Material Factor  $K$ (for steel forging and carbon steel casting)**

$\sigma_Y$ (N/mm <sup>2</sup> )	$K$
$\sigma_Y > 235$	$K = \left[ \frac{235}{\sigma_Y} \right]^{0.75}$
$\sigma_Y \leq 235$	$K = \left[ \frac{235}{\sigma_Y} \right]^{1.0}$
NOTE: $\sigma_Y$ = yield stress (N/mm <sup>2</sup> ) of material used, and not to exceed 0.7 $\sigma_T$ or 450 (N/mm <sup>2</sup> ) whichever is smaller in value. $\sigma_T$ = minimum tensile strength of material used (N/mm <sup>2</sup> ).	

**Table 4.1.2 Material Factor  $K$ (for rolled steel)**

Material	$K$
RA, RB, RD or RE	1.0
RA32, RD 32 or RE 32	0.78
RA 36, RD 36 or RE 36	0.72

**103. Sleeves and bushes**

Bearings from the bottom of the rudder to well above the load line are to be provided with sleeves and bushes.

**Section 2 Rudder Force**

**201. Rudder force**

- The rudder force  $F_R$  upon which the rudder scantlings are based is obtained from the following formula.

$$F_R = 0.05 (H^2 + 2A) V_R^2 \quad (\text{kN})$$

$H$  : mean height of that part of the rudder which is situated abaft the centre line of the rudder stock

$A$  : total area of rudder

$V_R$  : maximum service speed. However, if the maximum output of the propelling machinery exceeds the normal output which corresponds to the contracted speed by 15 % or more, is to be increased by the percentage in **Table 4.1.3**.

**Table 4.1.3  $V_R$  Increase Percentage (%)**

Maximum engine output above normal (%)	15	20	25	30	35	40
$V_R$ increase (%)	3	5	7	9	11	12

- For rudders which at no angle of helm work in the slipstream behind a propeller, the rudder force may be taken as 80 % of that obtained from the formula in **Par 1**.

## Section 3 Rudder Torque

### 301. Rudder torque

The torque of general type rudder is to be obtained from the following formula.

$$T_R = F_R r \quad (\text{kN} \cdot \text{m})$$

$F_R$  : as defined in **201**.

$r$  : distance (m) from the center of rudder force on the rudder to the centerline of the rudder stock, determined by the following formula.

$$r = b(a - e) \quad (\text{m})$$

For the ahead condition, however,  $r$  is not to be less than  $r_{\min}$  obtained from the formula.

$$r_{\min} = 0.1 b$$

$b$  : mean breadth (m) of rudder determined by the coordinate system in **Fig 4.1.2**

$a$  : as defined in **Table 4.1.4**

$e$  : the balance factors of the rudder obtained from the following formula.

$$e = \frac{A_f}{A}$$

$A_f$  : portion of the rudder plate area situated ahead of the centerline of the rudder stock (m<sup>2</sup>)

$A$  : as defined in **201**.

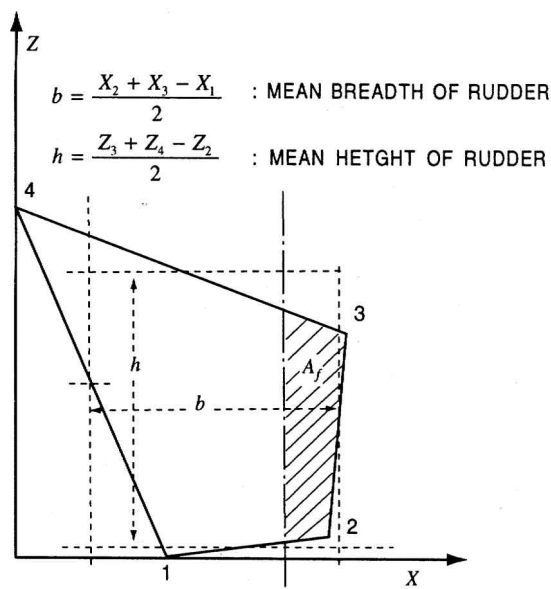

Fig 4.1.2 Coordinate System of Rudders

Table 4.1.4 Factor  $a$

Course of rudder	$a$
Ahead condition	0.33
Astern condition	0.66

## Section 4 Rudder Strength Calculation

### 401. Rudder strength calculation

- The rudder strength is to be sufficient to withstand the rudder force and rudder torque as given in **Sec 2** and **Sec 3**. When the scantling of each part of a rudder is determined, the following moments and forces are to be considered.
  - For rudder body : bending moment and shear force
  - For rudder stock : bending moment and torque
  - For rudder stock bearing : supporting force
- The bending moments, shear forces and supporting forces under consideration are to be determined by a direct calculation or approximate simplified method as deemed appropriate by the Society.

## Section 5 Rudder Stocks

### 501. Upper stocks

The upper stock diameter  $d_u$  required for the transmission of the rudder torque is to be determined so that the torsional stress not exceed  $68/K_S$  (N/mm<sup>2</sup>). The dimensions of the upper stock diameter may be determined by the following formula.

$$d_u = 43 \sqrt[3]{T_R K_S} \quad (\text{mm})$$

$T_R$  : as defined in **301**.

$K_S$  : material factor for rudder stock, as given in **102**.

### 502. Lower stocks

If the lower stock is subjected to combined torque and bending, the equivalent stress in the lower stock is not to exceed  $118 / K_S$  (N/mm<sup>2</sup>).

$$\sigma_e = \sqrt{\sigma_b^2 + 3 \tau_t^2} \quad (\text{N/mm}^2)$$

$\sigma_b$  and  $\tau_t$  : the bending stress and torsional stress acting on the lower stock, determined as follows respectively.

$$\sigma_b = \frac{10.2M}{d_l^3} \times 10^3 \quad (\text{N/mm})$$

$$\tau_t = \frac{5.1 T_R}{d_l^3} \times 10^3 \quad (\text{N/mm})$$

$M$  : bending moment(N · m) at the section of the rudder stock considered.

$T_R$  : as defined in **301**.

When the horizontal section of the lower stock forms a circle, the lower stock diameter  $d_l$  may be determined by the following formula.

$$d_l = d_u \sqrt[6]{1 + \frac{4}{3} \left( \frac{M}{T_R} \right)^2} \quad (\text{mm})$$

$d_u$  : upper stock diameter(mm) as given in **501**.

## Section 6 Rudder Plates, Rudder Frames and Rudder Main Pieces

### 601. Rudder plate

The rudder plate thickness  $t$  is not to be less than that obtained from the following formula :

$$t = 5.5 S \beta \sqrt{\left( d + \frac{F_R \times 10^{-1}}{A} \right) K_{pl} + t_c} \quad (\text{mm})$$

$\beta$  : as defined in the following formula.

$$\beta = \sqrt{1.1 - 0.5 \left( \frac{S}{a} \right)^2}, \quad \text{maximum : } 1.0 \left( \frac{a}{S} \geq 2.5 \right)$$

$t_c$  : 2.0 (for steel), or 0 (for stainless steel, composite material and aluminium).

$S$  : spacing of horizontal or vertical rudder frames, whichever is smaller (m).

$a$  : spacing of horizontal or vertical rudder frames, whichever is greater (m).

$K_{pl}$  : material factor of rudder plate as given in **102**.

$d$  : as specified in **Pt 3, Ch 1, 106**.

### 602. Rudder frames

1. The rudder body is to be stiffened by horizontal and vertical rudder frames enabling it to act as a bending girder.
2. The standard spacing of horizontal rudder frames,  $S_f$  is to be obtained from the following formula.

$$S_f = 0.2 \left( \frac{L}{100} \right) + 0.4 \quad (\text{m})$$

3. The standard distance from the vertical rudder frame forming the rudder main piece to the adjacent vertical rudder frame is to be 1.5 times the spacing of the horizontal rudder frames.
4. The thickness of rudder frames is not to be less than 8 mm or 70 % of the thickness of the rudder plates as given in **601**, whichever is greater.

### 603. Rudder main pieces

1. Vertical rudder frames forming the rudder main piece are to be arranged forward and afterward of the centerline of the rudder stock at a distance approximately equal to the thickness of the rudder where the main piece consists of two rudder frames, or at the centerline of the rudder stock where the main piece consists of one rudder frame.
2. The section modulus of the main piece is to be calculated in conjunction with the vertical rudder frames specified in **Par 1** and rudder plates attached thereto. The effective breadth of the rudder plates normally taken into calculation are to be as follows :
  - (1) Where the main piece consists of two rudder frames, the effective breadth is 0.2 times the length of the main piece.
  - (2) Where the main piece consists of one rudder frame, the effective breadth is 0.16 times the length of the main piece.
3. The section modulus and the web area of a horizontal section of the main piece are to be such that bending stress, shear stress and equivalent stress will not exceed the following stress values, respectively.

$$\sigma_b = \frac{100}{K_m} \quad (\text{N/mm}^2)$$

$$\tau = \frac{50}{K_m} \quad (\text{N/mm}^2)$$

$$\sigma_e = \sqrt{\sigma_b^2 + 3\tau^2} = \frac{120}{K_m} \quad (\text{N/mm}^2)$$

$K_m$ : material factor for the rudder main piece as given in **102**.

4. The upper part of the main piece is to be constructed so as to avoid structural discontinuity.

### 604. Connections

Rudder plates and frames are to be effectively connected and free from defects.

### 605. Paintings and drainage

The internal surface of the rudder is effectively coated with paint, and a means for drainage is to be provided at the bottom of rudder.

## Section 7 Couplings between Rudder Stocks and Main Pieces

### 701. Horizontal flange couplings

1. Coupling bolts are to be reamer bolts.
2. Couplings are to comply with the requirements in **Table 4.1.5**.

**Table 4.1.5 The Minimum Requirements for Horizontal Flange Couplings**

Parameter	Requirement
$n$	6
$d_b$	$0.62 \sqrt{\frac{d^3 K_b}{n e_m K_s}}$
$t_f$	$d_b \sqrt{\frac{K_f}{K_b}}$ (not less than $0.9 d_b$ ) <sup>(1)</sup>
$w_f$	$0.67 d_b$
<p><math>n</math> : total number of bolts.  <math>d_b</math> : bolt diameter (mm).  <math>d</math> : stock diameter (mm), the greater of the diameters <math>d_u</math> or <math>d_l</math> according to <b>501</b>. and <b>502</b>. (mm).  <math>e_m</math> : mean distance (mm) of the bolt axes from the centre of the bolt system.  <math>K_s</math> : material factor for the rudder stock as given in <b>102</b>.  <math>K_b</math> : material factor for the bolts as given in <b>102</b>.  <math>K_f</math> : material factor for the coupling flange as given in <b>102</b>.  <math>t_f</math> : the thickness (mm) of the coupling flanges.  <math>w_f</math> : the width (mm) of the material outside the bolt holes of the coupling flanges.</p>	
<p>NOTE:  (1) In way horizontal flange couplings, <math>t_f</math> are to be calculated from <math>d_b</math> and determined by a number of bolts not exceeding 8.</p>	

### 702. Cone couplings

1. Cone couplings without hydraulic arrangements (oil injection and hydraulic nut, etc.) for mounting and dismantling the coupling are to comply with the following :
  - (1) The couplings are to have a taper on diameters of 1:8 ~ 1:12 and be secured by the slugging nut (refer to **Fig 4.1.3**).
  - (2) The taper length  $l$  of rudder stocks fitted into the rudder plate is generally not to be less than 1.5 times the rudder stock diameter  $d_o$  at the top of the rudder.
  - (3) For the couplings between stock and rudder, a key is to be to the discretion of the Society.
  - (4) The dimensions of the slugging nut as specified in (1) above are to be as follows, (refer to **Fig 4.1.3**).

$$d_g \geq 0.65 d_o \quad (\text{mm})$$

$$h_n \geq 0.6 d_s \quad (\text{mm})$$

$$d_n \geq 1.2 d_e, \text{ whichever is greater}$$

$d_g$  : external thread diameter (mm).

$h_n$  : length of nut (mm).

$d_n$  : outer diameter of nut (mm).

- (5) The nuts fixing the rudder stocks must have efficient locking devices such as lock nut, nut stopper, etc. (refer to **Fig 4.1.3**).

(6) Couplings of rudder stocks are to be properly protected from corrosion.

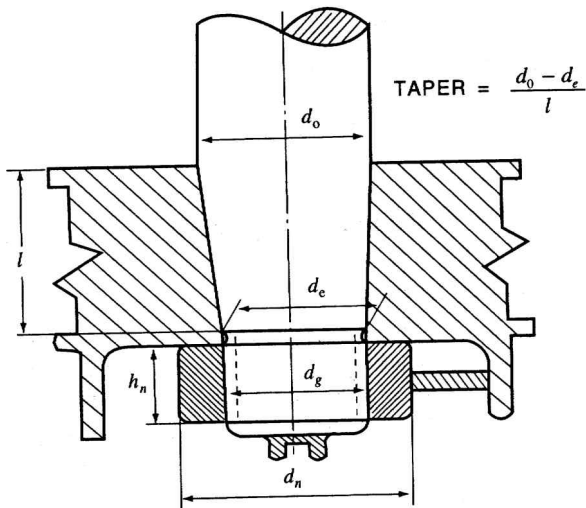

Fig 4.1.3 Cone Coupling without Hydraulic Arrangement

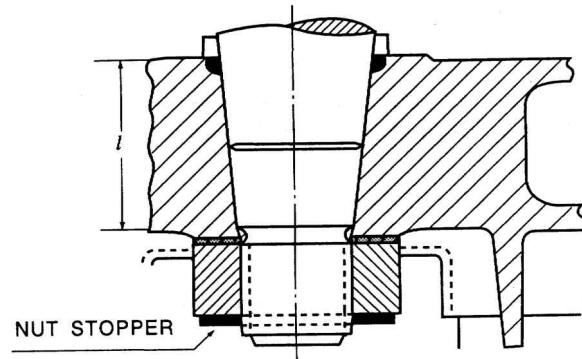

Fig 4.1.4 Cone Coupling with Hydraulic Arrangement

2. Cone couplings with hydraulic arrangements (oil injection and hydraulic nut, etc.) for mounting and dismounting the coupling are to comply with the following :
  - (1) Couplings are to have a taper on diameters of 1:12 ~ 1:20. The push-up force and push-up length are to be at the discretion of the Society.
  - (2) Nuts fixing the rudder stocks must have efficient locking devices. However, a plate for securing the nut against the rudder body is not to be provided.
  - (3) Couplings of rudder stocks are to be protected from corrosion.
  - (4) The dimensions of the securing nuts are to be as specified in **Par 1**, (4).

## Section 8 Bearings of Rudder Stocks

### 801. Minimum bearing surface

The bearing surface  $A_b$  (defined as the projected area : bearing length  $\times$  outside diameter of sleeve) is not to be less than that obtained from the following formula :

$$A_b = \frac{B}{q_a} \quad (\text{mm}^2)$$

$B$  : reaction force in bearing (N).

$q_a$  : allowable surface pressure (N/mm<sup>2</sup>) as given in **Table 4.1.6**. When verified by tests, however, value different from those in this Table may be taken.

**Table 4.1.6**

Bearing material	$q_a$ (N/mm <sup>2</sup> )
Lignum vitae	2.5
White metal (oil-lubricated)	4.5
Synthetic materials with hardness between 60 and 70, Shore HSD <sup>(1)</sup>	5.5
Steel <sup>(2)</sup> , bronze and hot pressed bronzegraphite materials	7.0
NOTE:	
(1) Indentation hardness test at the temperature of 23°C and humidity of 50 %, according to a recognized standard. Synthetic bearings are to be of approved type.	
(2) Stainless and wear-resistant steel in an approved combination with a stock liner.	

### 802. Length of bearings

The length of the bearing surface  $h_b$  is not to be greater than  $1.2 d_{sl}$  (mm).

$d_{sl}$  = diameter obtained from the external surface of the sleeve of rudder stocks

### 803. Bearing clearances

For metal bearings clearances are not to be less than  $d_{bs}/1000+1.0$  (mm) in the diameter.

$d_{bs}$  : the internal diameter of bush (mm).

### 804. Thickness of bush and sleeve

The thickness of any bush or sleeve  $t$  is not to be less than that obtained from the following formula :

$$t = 0.01\sqrt{B} \quad (\text{mm})$$

However,  $t$  is not to be less than  $t_{min}$  as follows.

$t_{min} = 8$  mm for metallic materials and synthetic materials.

$t_{min} = 22$  mm for lignum vitae.



---

## Section 9 Rudder Accessories

### 901. Rudder carriers

Suitable rudder carriers are to be provided for supporting the weight of rudder according to the form and the weight of the rudder, and care is to be taken to provide efficient lubrication at the support.

### 902. Jumping stoppers

Suitable arrangements are to be provided to prevent the rudder from jumping due to wave shocks.  
↓

## CHAPTER 2 HULL APPENDAGES

### Section 1 General

#### 101. Application

The requirements in this chapter apply to hull appendages necessary for satisfactory performing of the following functions : propulsion, steering, dynamic lift, etc., such appendages except for the rudder include rudder post, shaft brackets, foils. The requirements include structural strength of hull foundations for the above items, and for appended propulsion units such as waterjets.

#### 102. Definitions

- (1) Redundancy is the ability of a component or system to maintain or restore its function when one failure has occurred. Redundancy can be achieved for instance by installation of more units or alternative means for performing a function.
- (2) Operational condition is operation within sea state/speed restrictions for which the strength of the craft has been approved.
- (3) Dynamic lift is support of craft other than hydrostatic support.

#### 103. Approval of plans and documents

1. The following plans are to be submitted for approval.
  - (1) Structure plan of rudder post
  - (2) Structure plan of shaft brackets
  - (3) Detail plan of waterjet components
  - (4) Detail plan of waterjet shaft and tunnel
  - (5) Structure plan of foil
  - (6) Detail plan of hull foundations supporting appendages
2. The plans are to give full details of scantlings and their arrangement as well as the data necessary for verifying scantling calculations. Material specifications, welding and particulars about heat treatment are also required.

### Section 2 Materials and Workmanship

#### 201. Materials

The materials for members specified in this chapter are to comply with the requirements in **Pt 2** and **Pt 2, Ch 1.** of **Rules for the Classification of Steel Ships.**

#### 202. Material protection

1. When the appendage, or parts connected to it, is made from material different from the hull, such that a risk for galvanic corrosion arises, an approved coating system and/or approved cathodic protection will be required.
2. Fatigue resistance in sea water may have to be documented upon request.

#### 203. Welded constructions

1. Weld is to be full penetration weld only. Necessary preheating is to be applied for parts of substantial thickness, according to approved procedure.
2. Non-destructive testing is to be carried out on the following weld :
  - (1) Connection appendage/hull
  - (2) Connections between separate parts of the appendage (e.g., shaft boss/bracket arm)
  - (3) Important hull weld

- (4) Connection weld for ears for hydraulic cylinders and important link members
3. All weld are to be ground flush with the corners rounded well.

#### 204. Cast constructions

Surface finish is to be closely examined, after removal of lifting ears etc.

#### 205. FRP/sandwich constructions

1. Only approved raw materials are to be used. Lamination plans and procedure are to be approved before production starts.
2. Any overlamination of metal parts is to take place after thorough grinding of metal surfaces according to approved procedure.

### Section 3 Arrangement of Appendages

#### 301. Functional requirements

1. Within operational conditions, propulsion, steering and dynamic lift are not to be impaired by the craft's motions and accelerations. The arrangement should provide for maneuverability beyond the operational restrictions.
2. The arrangement is to be such that within the range of speed, any sudden manoeuvre will not lead to dangerous situations, including loss of control.

#### 302. Protection and accessibility

1. Water intakes to tunnels (e.g. for waterjet installations) are to be designed so as provide protection against clogging, protection which does not require that a grid is fixed on the waterjet duct inlet. Any outside protruding links, hydraulic equipment or other parts function from listed in **101**. are to be protected from mechanical damage.
2. Cathodic protection is to be arranged to the extent considered necessary.
3. Hollow constructions like rudders, welded shaft brackets, etc. are to be hydraulically tested with an internal test pressure of 0.2 kgf/cm<sup>2</sup> Drainage are to be provided. Following the pressure test, internal surfaces are to be covered by a corrosion resistant covering.
4. Items listed in **Par 1**. are to be accessible for inspection and immediate remedial action.
5. Housings for great systems, waterjet impellers, etc. are to be bolted to the hull to facilitate removal for servicing.

### Section 4 Design Loads and Supporting Structure

#### 401. Design loads

1. The following principles are to be applied when design loads are established.
  - (1) The application part is the weakest structure
  - (2) Progressive strength of components, so that hydrodynamic lift generating part is weakest link
  - (3) All relevant cases of asymmetrical loading during maneuvering
  - (4) Absence of ice
2. Specific loading criteria are given for the different applications.
3. Design loads are to be submitted together with documentation for approval.

#### 402. Foundations and strengthening

1. Major load carrying members are to be supported by properly aligned members inside the shell plating (floors, additional intercostal stiffeners).
2. It is essential that the supporting structure extends well outside the area of the supported appendage, and is well integrated with the craft's primary structure.
3. For appendages welded to the hull, major load carrying members may be required to be carried continuously through the shell plating to connect with the internal primary structure.
4. Shell plating in way of any appendage is to have a thickness not less than 1.5 times of thickness for shell plating at that location.
5. Floors, bottom girders and other internal structures are to have welding/bonding requirements increased by 50 %.

#### 403. Connections

1. Flanges and machined areas prepared for bolted connections are to be of substantial thickness, normally not less than 3 times the thickness for the shell plate at that location. The extent of substantial thickness flange plating are to be such that it is directly supported by internal structure (e.g., passing closest floor plating forward and aft of flange).
2. Machining of the bolted area is to take place after all welding in the area is completed.
3. Bolts are to be pretensioned according to an accepted standard.
4. When chockfast or similar is used, specification of type and pretension of bolts is to be documented.
5. After mounting, it is to be ensured that all gaps and corners are filled with compound. Smooth waterflow is to be ensured, to avoid undesirable cavitation creating surface erosion.

### Section 5 Rudder Posts

#### 501. Design loads and acceptable stress levels

1. Design rudder force as given in **Ch 1** is to be applied as design load.
2. When calculating normal and shear stresses for the rudder post cross section, acceptable stress levels are as for rudders
3. For slender rudder posts or rudder posts of unusual design, comprehensive calculation of structural strength will be required.

### Section 6 Shaft Brackets

#### 601. Design loads and acceptable stress levels

1. The following load conditions are to be considered :
  - (1) Most unfavourable side forces in a turn at full speed.
  - (2) Maximum bending moments and forces arising at full power.
  - (3) Maximum bending moments and forces arising with one propeller blade tip outside  $0.9 R$  missing.

#### 602. Twin arm brackets

1. Twin brackets are to have an angle between the legs of at least  $50^\circ$
2. Minimum plate thickness of at least 1.5 times rule requirement for shell plating.

### 603. Single arm brackets

Minimum plate thickness is to be at least 2 times the rule requirement for shell plating.

## Section 7 Foils

### 701. Approval of plans and documents

The following documentation is to be submitted for approval.

- (1) Arrangement drawing
- (2) Calculation of design loads
- (3) Calculation of stresses and deflections

## Section 8 Waterjets

### 801. Design loads

1. The following loading conditions are normally to be considered.
  - (1) Maximum ahead thrust
  - (2) Maximum side forces and moment
  - (3) Maximum external forces and moment in astern condition
2. The aft supporting area is to be adequately strengthening to sustain the design loads defined in **Par 1**.

### 802. Duct design

1. Tunnel supporting structures of shaft bearings are to adequately strengthening to main structures.
2. The tunnel plate thickness is to be at least 1.5 times the rule requirements for shell plating and adequately strengthening to avoid the large panel. ⚡

## CHAPTER 3 EQUIPMENT NUMBER AND EQUIPMENT

### Section 1 General

#### 101. General and Application [See Guidance]

1. The requirements in this chapter apply to equipment and installation for anchoring and mooring.
2. All craft, according to the equipment number given in **Sec 3**, are to be provided with anchors, chain cables, ropes, etc. which are not less than given in **Table 4.3.2**.
3. Anchors, chain cables, ropes, etc. for crafts having an equipment number of less than 30 or more than 500 are to be as determined by the Society.
4. The bower anchors given in **Table 4.3.2** are to be connected to their cables and stored on board ready for use.
5. The anchors, chain cables and ropes (equipment) which are to be tested and inspected for craft classed with this Society are to comply with the requirements of this chapter.
6. All craft are to be provided with suitable appliances for the handling of anchors.
7. The inboard end of chain cable is to be secured to the hull through a strong eye plate by means of shackle or by other equivalent means.
8. Provisions not mentioned in this chapter are to comply with **Pt 4, Ch 8**. of **Rules for the Classification of Steel Ships** or are to be in accordance with the Guidance.

#### 102. Materials

The materials for equipment specified in this chapter are to comply with each section and **Pt 2, Ch 1**. of **Rules for the Classification of Steel Ships**.

#### 103. Process of manufacture

The process of manufacture for equipment specified in this chapter is to comply with the requirements in each section.

#### 104. Tests and inspections

1. All equipment described in this chapter is to be tested and inspected in the presence of the Society's Surveyor in accordance with the requirements of this chapter and are to comply with the requirements for the tests and inspections.
2. Where equipment having characteristics differing from those described in this chapter are to be tested and inspected according to the approved specification other testing.
3. The tests and inspections for equipment may be dispensed with when they have appropriate certificates accepted by the Society.

#### 105. Execution of tests and inspections

1. The manufacturers shall provide the Surveyor with all necessary facilities and access the parts of the works necessary to verify that the approved process is adhered to.
2. All tests and inspections of equipment are to be carried out at the manufacturing site prior to delivery.

#### 106. Marking of accepted equipment

Equipment which satisfactorily complies with the requirements in this chapter are to be stamped in accordance with the provisions in each section.

### 107. Towing

1. Towing arrangements shall enable the craft to be towed in worst conditions.
2. The design towing force  $F_T$  is given by the following formula :

$$F_T = 480 THP \quad (\text{N})$$

$THP$  : towing horsepower at  $n$  knots  
( $n_{\min} = 5Kn$ ,  $n_{\max} = 10Kn$ )

3. Stresses for towing bollards are normally to give equivalent stress  $\sigma_c$  not exceeding  $160/K$  ( $\text{N}/\text{mm}^2$ ). The equivalent stress, for bollards in combined bending and shear may be taken as following formula.

$$\sigma_c = \sqrt{\sigma^2 + 3\tau^2} \quad (\text{N}/\text{mm}^2)$$

$\sigma$  : bending stress ( $\text{N}/\text{mm}^2$ ).

$\tau$  : shear stress ( $\text{N}/\text{mm}^2$ ).

$K$  : material factor as given in **Ch 1. 102.**

4. The towing arrangements and all bollards, eyebolts, fair leads and bitts should be constructed and attached to the hull that in the event of their damage, the watertight integrity of the craft is not impaired.

## Section 2 Structural Arrangement for Anchoring Equipment

### 201. General

1. The anchors are normally to be housed in hawse pipes of suitable size and form to prevent movement of the anchor and chain due to wave action.
2. The arrangements are to provide an easy lead of the chain cable from the windlass to the anchors.
3. Upon release of the brake, the anchor is to start falling immediately by its own weight.
4. At the upper and lower ends of hawse pipes, there are to be chafing lips.
5. The radius of curvature at the upper end should be such that at least 3 links of chain bear simultaneously on the rounded part. Alternatively, roller fairleads of suitable design may be fitted.
6. Where hawse pipes are not fitted, alternative arrangements will be specially considered.
7. The shell plating in way of the hawse pipes is to be increased in thickness and the framing reinforced as necessary to ensure a rigid fastening of the hawse pipes to the hull.
8. The chain locker is to have adequate capacity and suitable form to provide a proper stowage of the chain cable, and an easy direct lead for the cable into the chain pipes when the cable is fully stowed. When chain cable is substituted by wire or synthetic fibre ropes, the installation of chain locker may be exempted.
9. The chain locker boundaries and access openings are to be watertight and be made to minimize the probability of the chain locker being flooded in bad weather. Adequate drainage facilities of the chain locker are to be adopted.
10. Provisions are to be made for securing the inboard ends of chain to the structure. This attachment is to be able to withstand a force of not less than 15 %, nor more than 30 %, of the minimum breaking strength of the chain cable.
11. The fastening of the chain to the craft is to be made in such a way that in case of emergency when anchor and chain have to be sacrificed, the chain can readily be made to slip from an ac-

cessible position outside the chain locker.

12. The windlass and chain stoppers are to be effectively bedded to the deck. The deck plating in way of windlass and chain stopper is to be increased in thickness and supported by pillars carried down to rigid structures.
13. Crafts with bulbous bow or other protruding hull parts are to be reinforced in areas exposed to anchor/chain.

## Section 3 Equipment Number

### 301. Equipment number

1. The equipment number is obtained from the following formula :

$$E = \Delta^{\frac{2}{3}} + 2 Bh + 0.1 A$$

$\Delta$  : molded displacement (*t*) to the load line.

*h*, *A*: values specified in the following (1), (2), (3).

- (1) *h* is the value is obtained from the following formula :

$$h = f + \sum h' \sin \theta \quad (\text{m})$$

*f* : vertical distance (m) at the midship from the load line to the top of the uppermost continuous deck beam at side.

*h'* : height (m) from the uppermost continuous deck to the top of uppermost superstructures or deckhouses having a breadth greater than *B*/4. In the calculation of *h'* sheer and trim may be ignored.

*q* : angle of inclination aft of each front bulkhead.

- (2) *A* is the value obtained from the following formula.

$$A = fL + \sum h''l \quad (\text{m}^2)$$

*f* : as defined in previous (1).

$\sum h''l$  : summing up of the products of the height *h''* and length *l* (m) of superstructures, deckhouses or trunks which are located above the uppermost continuous deck within the length of craft also have a breadth greater than *B*/4 and a height greater than 1.5 m.

- (3) In the application of (1) and (2), screens and bulwarks more than 1.5 metres in height are to be regarded as parts of superstructure or deckhouses.
- (4) For catamarans the cross-sectional area of the tunnel above the waterline may be deducted from *Bh* in the previous formula.

### 302. Equipment reductions

The equipment is in general to be in accordance with the requirements given in **Table 4.3.2**, reduced as per **Table 4.3.1** in accordance with service restriction notation.



**Table 4.3.1 Equipment Reductions for Service Restriction Notation (2018)**

Class notation	Bower anchors		Stud-link chain cables
	Number	Mass change per anchor	Length change
SA0, SA1	1	No reduction	No reduction
SA2, SA3	1	-30 %	No reduction
SA0, SA1	2	-30 %	+60 %
SA2, SA3	2	-30 %	+60 %
NOTE: SA4 and SA5 may be specially considered.			

## Section 4 Anchors

### 401. Applications

The anchors on craft dealt with in this chapter are to comply with the requirements below or be of equivalent quality.

### 402. General

#### 1. Anchor types

- (1) H.H.P. (high holding power) anchor
- (2) S.H.H.P. (super high holding power) anchor

2. When two anchors are selected, the mass of individual anchors may vary by  $\pm 7\%$  of the values given in **Table 4.3.2**, provided that the total mass of anchors is not less than would have been required for anchors of equal mass.
3. The mass of the head is not to be less than 60 % of the values in **Table 4.3.2**.

### 403. Materials

Materials used for anchors are to comply with **Pt 4, Ch 8.** of **Rules for the Classification of Steel Ships**.

### 404. Drop and hammering tests

Drop and hammering tests are to comply with **Pt 4, Ch 8.** of **Rules for the Classification of Steel Ships**.

### 405. Proof tests

Proof tests of anchor are to comply with **Pt 4, Ch 8.** of **Rules for the Classification of Steel Ships**. The proof test load, however, for high holding power anchor is to be the load specified for an ordinary anchor of which the mass is equal to 2 times the actual total mass of a high holding power anchor.

### 406. Additional requirements for S.H.H.P. anchors

1. S.H.H.P. anchors for which approval is sought, are to be tested by requirements in Guidance for Approval of Manufacturing Process and Type Approval, ETC. to show that they have a holding power per unit of mass at least 4 times that of an ordinary stockless anchor.
2. If approval is sought for a range of anchor sizes, at least two sizes are to be tested. The mass of

the larger anchor to be tested is not to be less than 1/10 of that of largest anchor for which approval is sought. The smaller of the two anchors to be tested is to have a mass not less than 1/10 of that of the larger anchor to be tested.

#### 407. Marking

1. Where anchors have satisfactorily passed the tests and inspections, they are to be stamped with the Society's brand in compliance with **Pt 4, Ch 8.** of **Rules for the Classification of Steel Ships.**
2. In case of high holding power anchors, "SH" is to be stamped in front of the Society's brand in addition to the stamps specified in **Par 1.**

### Section 5 Anchor Chain Cables

#### 501. General

1. Anchor chain cables are to comply with **Pt 4, Ch 8.** of **Rules for the Classification of Steel Ships.**
2. Wire rope or synthetic fibre rope may be used instead of stud link chain cable, provided that they have at least the same breaking strength.
3. If ordinary, short link chain cable or wire rope is used instead of stud link chain cable, the same breaking strength will be required.
4. When chain cable is substituted by wire or synthetic fibre rope, a short length of chain cable is to be fitted between the anchor and wire rope. The length is to be the distance between anchor in stowed position and windlass, and not less than  $0.2 L$  (m). However, shorter length may be considered on a case by case basis, provided that the weight of chain is not reduced.

### Section 6 Wire Ropes

#### 601. Application

Wire ropes are to comply with **Pt 4, Ch 8.** of **Rules for the Classification of Steel Ships.** ↓

Table 4.3.2 Bower Anchors, Chain Cables and Ropes

Equipment letter	Equipment number		Bower anchors			Stud link chain cable for bower anchors <sup>(1)</sup>					Mooring line		
			Mass (kg)			Total Length (mm)	Diameter			Breaking load (kN)	Number	Length (m)	Breaking load (kN)
	Exceeding	Not exceeding	Number	HHP	SHHP		Grade 1	Grade 2	Grade 3				
HS1	30	40	1	93	62	115	12.5			66	2	40	32
HS2	40	50	1	119	79	115	12.5			66	2	40	32
HS3	50	60	1	146	97	130	14	12.5		82	3	40	34
HS4	60	70	1	171	114	130	14	12.5		82	3	40	34
HS5	70	80	1	198	138	130	16	14		107	3	50	37
HS6	80	90	1	224	149	130	16	14		107	3	50	37
HS7	90	100	1	251	167	150	17.5	16		127	3	55	39
HS8	100	110	1	276	184	150	17.5	16		127	3	55	39
HS9	110	120	1	303	202	150	19	17.5		150	3	55	44
HS10	120	130	1	329	219	150	19	17.5		150	3	55	44
HS11	130	140	1	356	237	165	20.5	17.5		175	3	60	49
HS12	140	150	1	383	255	165	20.5	17.5		175	3	60	49
HS13	150	160	1	408	272	165	22	19		200	3	60	54
HS14	160	175	1	441	294	165	22	19		200	3	60	54
HS15	175	190	1	480	320	180	24.5	20.5		237	3	60	59
HS16	190	205	1	521	347	180	24.5	20.5		237	3	60	59
HS17	205	220	1	560	373	180	26	22	20.5	278	4	60	64
HS18	220	240	1	606	404	180	26	22	20.5	278	4	60	64
HS19	240	260	1	659	439	200	28	24	22	321	4	60	69
HS20	260	280	1	711	474	200	28	24	22	321	4	60	69
HS21	280	300	1	764	509	215	30	26	24	368	4	70	74
HS22	300	320	1	816	544	215	30	26	24	368	4	70	74
HS23	320	340	1	869	579	215	32	28	24	417	4	70	78
HS24	340	360	1	926	617	215	32	28	24	417	4	70	78
HS25	360	380	1	974	649	230	34	30	26	468	4	70	88
HS26	380	400	1	1028	685	230	34	30	26	468	4	70	88
HS27	400	425	1	1086	724	230	36	32	28	523	4	70	98
HS28	425	450	1	1152	768	230	36	32	28	523	4	70	98
HS29	450	475	1	1226	817	230	36	32	28	523	4	70	108
HS30	475	500	1	1284	856	230	38	34	30	581	4	70	108

To be continued next page.

Table 4.3.2 Bower Anchors, Chain Cables and Ropes (continued)

Equip- ment letter	Equipment number		Bower anchors			Stud link chain cable for bower anchors <sup>(1)</sup>					Mooring line		
			Mass (kg)			Total Length (mm)	Diameter			Breaking load (kN)	Num- ber	Length (m)	Breaking load (kN)
	Exce- - eding	Not exce- - eding	Num- ber	HHP	SHHP		Grade 1	Grade 2	Grade 3				
HS31	500	550	1	1403	935	248	40	34	30	640	4	80	123
HS32	550	600	1	1535	1024	264	42	36	32	703	4	80	132
HS33	600	660	1	1694	1129	264	44	38	34	769	4	80	147
HS34	660	720	1	1853	1235	264	46	40	36	837	4	80	157
HS35	720	780	1	2012	1341	281	48	42	36	908	4	85	172
HS36	780	840	1	2171	1447	281	50	44	38	981	4	85	186
HS37	840	910	1	2329	1553	281	52	46	40	1060	4	85	201
HS38	910	980	1	2515	1676	297	54	48	42	1140	4	85	216
HS39	980	1060	1	2700	1800	297	56	50	44	1220	4	90	230
HS40	1060	1140	1	2912	1941	297	58	50	46	1290	4	90	250
HS41	1140	1220	1	3124	2082	314	60	52	46	1380	4	90	270
HS42	1220	1300	1	3335	2224	314	62	54	48	1470	4	90	284
HS43	1300	1390	1	3574	2382	314	64	56	50	1560	4	90	309
HS44	1390	1480	1	3812	2541	330	66	58	50	1660	5	90	324
HS45	1480	1570	1	4050	2700	330	68	60	52	1750	5	95	324
HS46	1570	1670	1	4315	2876	330	70	62	54	1840	5	95	333
HS47	1670	1790	1	4632	3088	347	73	64	56	1990	5	95	353
HS48	1790	1930	1	4950	3300	347	76	66	58	2150	5	95	378

NOTE :  
(1) Chain cable may be substituted by wire or synthetic fibre rope, according to 501.

## CHAPTER 4 HATCHWAYS, WINDOWS AND OTHER OPENINGS

### Section 1 Hatchways and Other Deck Openings

#### 101. Application

Hatchways and other openings are to comply with the following :

- (1) Hatchways closed by weathertight covers
  - (A) Coaming heights are in general not to be less than 100 mm for hatches to weathertight spaces on decks above the datum, and 250 mm elsewhere. For craft of 30 m in length and under, coaming heights may be reduced to the maximum which is consistent with the safe working of the craft;
  - (B) The height of these coamings may be reduced, or the coamings omitted entirely, on condition that this Society is satisfied that the safety of the ship is not thereby impaired in any sea conditions up to the worst intended conditions.
  - (C) Where coamings are provided, they are to be of substantial construction and the arrangements for securing and maintaining weather tightness shall ensure that the tightness can be maintained in any sea conditions up to the worst intended conditions.
- (2) Machinery space openings
  - (A) Machinery space openings are to be properly framed and efficiently enclosed by casings of ample strength and, where the casings are not protected by other structures, their strength shall be specially considered. Access openings in such casings shall be fitted with weathertight doors.
  - (B) Heights of sills and coaming are, in general, not to be less than 100 mm for openings to weathertight spaces on decks above the datum, and 380 mm elsewhere. For craft of 30 m in length and under, these heights may be reduced to the maximum which is consistent with the safe working of the craft.
  - (C) Machinery space ventilator openings are to comply with the requirements of **Sec 201.** in this Chapter.
- (3) Miscellaneous openings in exposed decks
  - (A) Manholes and flush scuttles on the datum or within superstructures other than enclosed superstructures are to be closed by substantial covers capable of being made watertight. Unless secured by closely spaced bolts, the covers shall be permanently attached.
  - (B) Service hatches to machinery, etc. may be arranged as flush hatches provided that the covers are secured by closely spaced bolts, are kept closed at sea, and are equipped with arrangements for portable guardrails.
  - (C) Openings in exposed decks leading to spaces below the datum or enclosed superstructures other than hatchways, machinery space openings, manholes and flush scuttles shall be protected by an enclosed superstructure, or by a deckhouse or companionway of equivalent strength and weather tightness.
  - (D) The height above the deck of sills to the doorways in companionways are, in general, not to be less than 100 mm for doors to weathertight spaces on decks above the datum, and 250 mm elsewhere. For craft of 30 m in length and under sill heights may be reduced to the maximum which is consistent with the safe working of the craft.

### Section 2 Bulwarks, Freeing Ports, Side Scuttles, Ventilators

#### 201. Application

Bulwarks, freeing port, side scuttles, ventilators are to comply with the followings and **Pt 4, Ch 4.** of **Rules for the Classification of Steel Ships.**

- (1) Ventilators
  - (A) Ventilators to spaces below the datum or decks of enclosed superstructures are to have substantially constructed coamings efficiently connected to the deck. Coaming heights are in general not to be less than 100 mm for ventilators to weathertight spaces on decks above the datum, and 380 mm elsewhere. For craft of 30 m in length and under, coaming heights may be reduced to the maximum which is consistent with the safe working of the craft.

- (B) Ventilators the coamings of which extend to more than one metre above the deck or which are fitted to decks above the datum need not be fitted with closing arrangements unless they face forward.
- (C) Except as provided in the above mentioned (B), ventilator openings are to be provided with efficient weathertight closing appliances.
- (D) Ventilator openings are to face aft or athwartships wherever practicable.

(4) Freeing ports

- (A) Where bulwarks on weather decks form wells, ample provision is to be made for rapidly freeing the decks of water and for draining them. The minimum freeing port area ( $A$ ) on each side of the craft for each well on the weather deck of the main hull(s) are to be:
  - (a) where the length of bulwark ( $l$ ) in the well is 20 m or less:

$$A = 0.7 + 0.035 l \quad (\text{m}^2)$$

- (b) where  $l$  exceeds 20 m:

$$A = 0.070 l \quad (\text{m}^2)$$

and, in no case,  $l$  need be taken as greater than  $0.7 L$ .

- (B) If the bulwark is more than 1.2 m in average height, the required area is to be increased by 0.004 square metres per metre of length of well for each 0.1 m difference in height. If the bulwark is less than 0.9 m in average height, the required area is to be decreased by 0.004 square metres per metre of length of well for each 0.1 m difference in height.
- (C) Such freeing ports are to be located within the height of 0.6 m above the deck and the lower edge is to be within 0.02 m above the deck.
- (D) All such openings in the bulwarks are to be protected by rails or bars spaced approximately 230 mm apart. If shutters are fitted to freeing ports, ample clearance is to be provided to prevent jamming. Hinges are to have pins or bearings of non-corrodible material. If shutters are fitted with securing appliances, these appliances are to be of approved construction.
- (E) Craft, having superstructures which are open in front or both ends, is to comply with the provisions of the above mentioned (A).
- (F) In craft, having superstructures which are open at the aft end, the minimum freeing port area is to be:

$$A = 0.3 b \quad (\text{m}^2),$$

where:

$b$  : the breadth of the craft at the exposed deck (m).

- (G) Ro-Ro craft fitted with bow loading openings leading to open vehicle spaces is to comply with the provisions of **Pt 3, Ch 1, Sec 407**.

## Section 3 Windows

### 301. General

1. Windows in sides and ends of superstructures and deckhouses are to be of toughened safety glass and firmly mounted in stiff aluminium frames so that the glass is placed inside the outer point of side.
2. For craft with service restriction SA4, rubber frames may be accepted, provided the cross section is designed to increase the grip on the glass as the lateral pressure from outside is increased.
3. Materials other than toughened safety glass, except for front windows in wheelhouse, may be considered by the Society. The thickness is then to be adapted to the strength of the material concerned.
4. Window glass panes with heating wires are to be considered with regard to their reduced strength.
5. The cutouts for windows are to have well-rounded corners.

### 302. Thickness of glasses

1. The thickness of toughened safety glass panes is not to be less than that obtained from the following formula :

$$t = \frac{b}{K_w} \sqrt{\beta p} \quad (\text{mm})$$

$b$  : small dimension of window openings (mm).

$K_w$ : 200, for toughened safety glass

190, for polycarbonate

$p$  : lateral pressure defined in **Pt 3, Ch 2, 304**.

$\beta$  : factor, taken from **Fig 4.4.1**, dependent on the aspect ratio of the window.

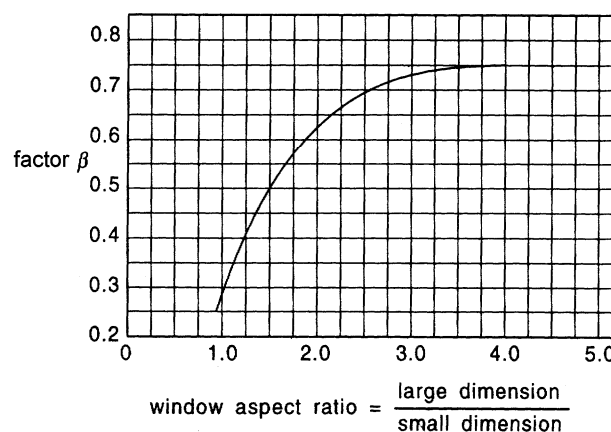

Fig 4.4.1 Diagram for Factor  $\beta$  for Windows

2. The thickness of toughened safety glass panes may be reduced from that given by the formula in **Pt 3, Ch 2, 304**, when it is documented by a pressure test that the window fitted in the type of frame to be used is able to withstand a test pressure of 4 times the lateral design pressure according to previous **Par 1** above without the window dropping out of the frame or leakage occurring. The thickness is not to be less than 5 mm.
3. Large glass doors or windows in the aft end of superstructures or deckhouses will be specially considered.

- Windows of other materials than toughened safety glass ; i.e., polycarbonate, are to be tested in the type of frame to be used to a test pressure of 4 times the lateral design pressure according to **Pt 3, Ch 2**. It is to be documented that the window shows no sign of defects as specified in **Par 2**. Windows firmly fixed in the frames by bolting, gluing or other equivalent methods may be tested to a pressure of 2.5 times the lateral design pressure according to **Pt 3, Ch 2**. The thickness is not to be less than 5 mm.

### 303. Deadlights

- The number of deadlights in relation to number of windows depending on the service restriction notation, is to be as given in **Table 4.4.3**.

**Table 4.4.3 Number of Deadlights**

Location	Service area restriction notation			
	SA0	SA1	SA2	SA3
Superstructure front 1 tier	100 %	100 %	50 %	25 %
Superstructure side	1 to each type of window 1 extra to dominating type of window			0
Deckhouse front 2 tier and above	1 to each type of window 1			0
Deckhouse side 2 tier and above	1 to each type of window 1			0
NOTE: SA 4 may be specially considered.				

- Deadlights are to be interchangeable port and starboard.
- Deadlights are to be stowed in such a way as to provide quick mounting. Deadlights for which there is 100 % requirement, are to provide protection for intact windows. Other deadlights are to provide temporary replacement of damaged windows and may be mounted internally or externally over window openings. ↓



**PART 5**  
**MACHINERY INSTALLATIONS**

---

## CHAPTER 1 GENERAL

### Section 1 General

#### 101. Application

1. In case of high speed craft engaged on international voyages, the HSC Code is to be applied.
2. Other requirements for machinery installations not specified in this part are, in principle, to be in accordance with relevant requirements in **Rules for the Classification of Steel Ships**, other equivalent rules, or standards deemed appropriate by this Society. **【See Guidance】**

#### 102. Equivalency

In case of machinery installations that are not appropriate to the requirements of this part, they may be accepted, if the Society considers them appropriate.

#### 103. Construction in general

1. Machinery is to be designed, constructed and installed so as to minimize any danger to the safety of ships and people in working conditions.
2. Rotating parts, moving parts, high temperature parts or electrically charged parts of machinery are to suitably protect from injury those who watch, operate or approach the equipment. to avoid injury.
3. Machinery is to be constructed so it does not produce gases which will be harmful to operators or have fire risk. It is to be installed in well ventilated place.
4. Machinery is to be constructed and arranged in ways that make it easy to repair and inspect. ↓

## CHAPTER 2 AUXILIARIES AND PIPING ARRANGEMENT

### Section 1 General

#### 101. General

The materials to be used in piping systems are to be suitable for the medium and service for which the system is intended. Unless specifically mentioned in this chapter, all metallic materials with melting points above 900°C may be used.

#### 102. Materials for piping arrangement

1. Copper and copper alloy pipes, valves and pipe fittings
  - (1) Copper and copper alloy pipes, valves and pipe fittings are not to be used for piping arrangements having design temperatures above the limits below. However, special bronze, suitable for high temperature service under the approval of the Society, may be used for piping arrangements having design temperatures up to 260°C.
    - (A) Copper and aluminium brass : 200°C
    - (B) Copper nickel : 300°C
  - (2) Pipes for starting air are not to be of copper or copper alloys when the outer diameter exceeds 44.5 mm.
2. Rigid plastic pipes may be used for Class III piping systems. However, service limitations and relevant data will be required by the Society. **【See Guidance】**
3. Aluminium pipes may be used for Class III piping systems. However, service limitations and relevant data will be specified by the Society. **【See Guidance】**

### Section 2 Bilge and Drainage Systems

#### 201. General

1. An efficient bilge pumping system is to be provided, capable of pumping from and draining any watertight compartment other than a space permanently appropriate for the carriage of liquid and for which other efficient means of pumping are provided, under all practical conditions.
2. Where fixed pressure water-spraying fire-extinguishing systems or other systems which will supply large quantities of water are fitted, an arrangement is to be fitted in the compartment to ensure that such water is discharged directly overboard.

#### 202. Bilge pumping system

1. At least one bilge suction which is effectively located is to be provided for every watertight compartment.
2. Arrangement is to be made whereby bilge in a watertight compartment may find its way to the bilge suction.
3. Where, in relation to particular compartments, bilge discharge is considered difficult, the bilge pumping system may be omitted, but it is to be demonstrated that the safety of the craft will not be impaired.
4. At least two bilge suction are to be provided in every machinery space, and all bilge suction pipes are to be provided with mud boxes which can be inspected and cleaned at easily accessible positions above the floor level of the machinery space.
5. In every watertight compartment where only portable bilge pumps are used to discharge bilge, means which are easily accessible to connect and operate bilge pumps are to be provided.

### 203. Prevention of flooding through bilge pipe

1. Bilge and ballast systems are to be provided with screw-down non-return valves so that water can not flow from overboard or ballast system to machinery spaces, cargo holds or other similar watertight compartments, or from one watertight compartment to others.
2. Screw-down non-return valves are to be provided between each branch bilge suction and distribution chest.

### 204. Bilge pumps

1. All craft are to be provided with at least two bilge pumps, of which one is to be used only for bilge discharge. All available pumps, which have relevant capacity and are not intended for oil transfer on board, may be considered as the second bilge pumps. **[See Guidance]**
2. Fixed or movable bilge pumps can be used, but pumps not less than 1.5 m<sup>3</sup>/hr, are to be power-driven.
3. The capacity  $Q$  of each bilge pump is to be not less than required by the following formula :

**[See Guidance]**

$$Q = 3.75(1 + L/36)^2 \quad (\text{m}^3/\text{hr})$$

$L$  : length of craft on design waterline (m).

4. The Society may accept bilge pumps having capacity less than required by **Par 3**, but not less than required by the following formula or 1 m<sup>3</sup>/hr, whichever is the more.

$$Q = 0.05 LW \quad (\text{m}^3/\text{hr})$$

$LW$  : light weight (ton)

5. In bilge pumping arrangements where a bilge main is not provided then, with the exception of the forward spaces forward of public spaces and crew accommodation, at least one submersible pump is to be provided for each space. In addition, at least one portable pump is to be provided, supplied from the emergency supply if electric, for use on individual spaces.
6. Manual pumps, if fitted, are to be located on the bulkhead deck or upward.
7. Internal diameters of suction branches are not to be less than 25 mm, and suction branches are to be fitted with effective strainers.
8. Every valve or cock is to be fitted with open/close indicator so that can be seen at its operating place.

## Section 3 Air, Sounding and Filling Pipes

### 301. Air pipes

1. All compartments and tanks arranged with filling and/or drainage arrangements are to have an air pipe.
2. All tanks containing flammable liquids, or which can be pumped up or filled from the sea, are to have air pipes extending above the weather deck.
3. Air pipes from fuel and lubricating oil systems are to be carried up to a position where water cannot enter, and be so arranged that vapor or overflow cannot be ignited.
4. All air pipes extending to exposed decks are to have a height from the deck to the point where water may have access below of at least 300 mm where the deck is less than 0.05  $L$  above the

design waterline, and 150 mm on all other decks.

5. Air pipes for tanks not fitted with overflow pipes are to have a cross sectional area not less than 125 % of the filling pipes.
6. Air pipes may discharge through the side of the superstructure provided that this is at a height of at least  $0.02 L$  above any waterline when the intact craft is heeled to an angle of  $15^\circ$  or  $0.02 L$  above the highest waterline at all stages of flooding as determined by the damaged stability calculations, whichever is higher.
7. All air pipes are to be equipped with approved weathertight closing devices that close automatically.

### 302. Sounding and filling pipes

1. All compartments and tanks arranged with filling and/or drainage arrangements are to have means for ascertaining the level of liquid.
2. All tanks containing flammable liquids or which can be pumped up or filled from the sea are to have sounding pipe carried up to the open air fitted with screw cap or equivalent. Other approved level indicator or remote sounding arrangement may replace sounding pipe.
3. Filling pipes to tanks containing flammable liquids are to terminate on the weather deck and are to be so arranged that possible spill cannot escape to the inside of the vessel, but will be collected inside a suitable arranged coaming.
4. All filling pipes to fuel and lubricating oil tanks are to have screw caps, plugs or similar arrangement preventing water from entering such tanks.

## Section 4 Ship-side Valves and Overboard Discharges

### 401. Scupper, inlets and discharges

1. A sufficient number of scuppers, arranged to provide effective drainage, are to be fitted to all tanks.
2. Scuppers on weather portions of decks and scuppers leading from superstructures or deckhouses not provided with closing appliances are usually to be led overboard.
3. Scuppers led through the deck or shell are to have strength equivalent to that of surrounding hull structure, and due regard is to be taken to the corrosion resistance of the piping material.
4. Scupper pipes are to be well stayed to prevent any vibrations. Sufficient possibility for extension of the pipes is to be provided when necessary.
5. Scuppers from spaces below the freeboard deck or spaces within closed superstructures may be led to bilges, and in this case, scuppers are to comply with the requirements given for discharges.
6. Scuppers from exposed superstructure deck, led through the craft's sides and not having closeable valves, are to have strength as required in **402. 4.**
7. Discharges led through the shell either from spaces below the freeboard deck or from spaces within superstructures and deckhouses on the freeboard deck, fitted with effective watertight doors, are to be provided with efficient means for preventing water from passing inboard. Normally, each separate discharge is to have one automatic check valve with positive means of closing it from a position above freeboard deck.
8. The vertical distance from the design waterline to the inboard end of the discharge pipe exceeds  $0.01L$ , the discharge may have two automatic non-return valves without positive means of closing, provided that the inboard valve is always accessible for examination under service conditions. Where that vertical distance exceeds  $0.02 L$ , a single automatic non-return valve without positive means of closing may be accepted. The means for operating the positive action valve is to be readily accessible and provided with an indicator showing whether the valve is open or closed.
9. Valves on scuppers from weathertight compartments included in the stability calculations are to be operable from the operating compartment.

10. In manned machinery spaces, main and auxiliary sea inlets and discharges in connection with the operation of machinery may be controlled locally. Such controls are to be readily accessible and are to be provided with indicators showing whether the valves are open or closed. In unmanned machinery spaces, main and auxiliary sea inlets and discharges in connection with the operation of machinery are to be operable from the operating compartment. **[See Guidance]**

#### 402. Ship-side valves and fittings

1. All sea inlets and discharges are to have easily operable valves of an approved type connected to the side or bottom of the craft by a substantial flange connection or equivalent.
2. The choice of material combination, dimensions and corrosion protection of the sea inlet and discharge valves connection to the sides and bottom of the craft, is to be arranged so that flooding due to damage of such fittings is avoided.
3. Exhaust outlets through the side of the craft are to be so arranged that ingress of water into the engine is avoided.
4. The thickness and diameter of piping between hull plating and closeable or non-return valve are to be chosen so as to achieve equivalent strength as the surrounding hull structure. Due regard is to be taken to the corrosion resistance of the piping material.

## Section 5 Fuel Oil System

### 501. Arrangement of fuel oil tanks

1. Fuel oil tanks for emergency diesel engines are to be located on or above the weather deck outside the engine housing or compartment and as close to the engine as practicable.
2. The fuel oil tanks are preferably to be part of the craft's structure and are to be located (except for double bottom tanks) outside fire hazard area.
3. For craft constructed of FRP or aluminium alloy, fuel oil tanks being constructed of same material are not to be installed in fire hazard area, nor to form part of the boundary to such spaces. But, fuel oil tanks with A-60 class insulation may be installed in fire hazard area.
4. Daily service tanks of steel or equivalent material may be permitted in fire hazard areas. All pipes connected to such tanks below the highest tank liquid level are to be arranged with remote quick-closing valves.

### 502. Piping conveying fuel or other flammable fluids

1. Piping conveying fuel or other flammable fluids are not to pass through passenger, cargo and crew compartments. Flexible fuel oil pipes are to be suitable for service conditions and are not to penetrate watertight bulkheads.
2. All fuel or other flammable liquid piping leading into fire hazard area are to be arranged with shut-off valves located outside the fire hazard area and easily to be accessible.

### 503. Fuel oil pumps and filters (2020)

1. Fuel oil pumps of internal combustion engines are to be in accordance with the requirements in **Pt 5, Ch 6, 903. 1 of Rules for the Classification of Steel Ships.**
2. Fuel oil filters of internal combustion engines are to be in accordance with the requirements in **Pt 5, Ch 6, 903. 2 of Rules for the Classification of Steel Ships.**

---

---

## Section 6 Lubricating Oil System

### 601. Lubricating oil pumps and filters (2020)

1. Lubricating oil pumps of internal combustion engines are to be in accordance with the requirements in **Pt 5, Ch 6, 802.** of **Rules for the Classification of Steel Ships.**
2. Fuel oil filters of internal combustion engines are to be in accordance with the requirements in **Pt 5, Ch 6, 804.** of **Rules for the Classification of Steel Ships.**
3. Where engines which do not require lubrication before starting, the stand-by lubricating oil pumps may be omitted.

## Section 7 Cooling Water System

### 701. Cooling water pumps (2020)

1. Cooling water pumps are to be in accordance with the requirements in **Pt 5, Ch 6, 701.** and **702.** of **Rules for the Classification of Steel Ships.**

## Section 8 Ventilation Systems

### 801. Ventilation systems of machinery spaces

1. A mechanical ventilation system with suitable inlets and outlets, including dampers, is to be provided for the machinery space.
  2. Calculated air quantity required is to be based on the sum of the air required for diesel engines and boilers, as well as the requirements for exhaustion of heat emitted from machinery and electrical equipment. In no case is air supply to be less than the sum of needed combustion air plus 50 %.
- ↓

---

## CHAPTER 3 PRIME MOVERS, POWER TRANSMISSION SYSTEMS AND LIFT DEVICES, ETC.

### Section 1 General

#### 101. Application

1. Internal combustion engines, gas turbines, shafting, power transmission systems, pressure vessels, etc. are to comply with the relevant requirements in **Rules for the Classification of Steel Ships** or other equivalent rules. **【See Guidance】**
2. The drawing approval and inspection for lift devices, including lifting fans are to be to the satisfaction of the Society. ↓



**PART 6**  
**ELECTRICAL EQUIPMENT AND CONTROL**  
**SYSTEMS**

## CHAPTER 1 ELECTRICAL EQUIPMENT

### Section 1 General

#### 101. Application

1. Requirements for electrical equipment not specified in this chapter are, in principle, to be in accordance with **Rules for the classification of Steel Ships**.
2. In case of high speed craft engaged on international voyages, the HSC code is to be applied.  
**[See Guidance]**
3. For ships not engaged on international voyages, the requirements in this chapter may be used as appropriate.

### Section 2 Electrical Equipment

#### 201. Earthing of non-metallic craft

1. To minimize the risk of fire, structural damage, electrical shock and radio interference due to lightning strike or electrostatic discharge, all metal parts of the craft are to be bonded together, in so far as possible in consideration of galvanic corrosion between dissimilar metals, to form a continuous electrical system, suitable for the earth return of electrical equipment and to connect the craft to the water when water-borne. The bonding of isolated components inside the structure is not generally necessary, except in fuel tanks.
2. Each pressure fueling point is to be provided with a means of bonding the fueling equipment to the craft.
3. Metallic pipes capable of generating electrostatic discharges, due to the flow of liquids and gases, are to be bonded so as to be electrically continuous throughout their length and they are to be adequately earthed.
4. Primary conductors for lightning discharge currents are to have a minimum cross section of 70 mm<sup>2</sup> in copper, or an equivalent surge carrying capacity in aluminium.
5. Secondary conductors provided for the equalization of static discharges, bonding of equipment, etc., but not for carrying lightning discharges, are to have a minimum cross section of 5 mm<sup>2</sup> copper or an equivalent surge current carrying capacity in aluminium.
6. The electrical resistance between bonded objects and the basic structure is not to exceed 0.02 ohms except where it can be demonstrated that a higher resistance will not cause a hazard. The bonding part is to have sufficient cross-sectional area to carry the maximum current likely to be imposed on it without excessive voltage drop.

#### 202. Emergency electrical equipment

1. The emergency source of electrical power in cargo craft is to be capable of supplying simultaneously at least the following services for the periods specified, having regard for starting currents and the transitory nature of certain loads, if they depend upon an electrical source for their operation and this requirement substitutes for **Pt 6, Ch 1, 203. 2 (2) of Rules for the Classification of Steel Ships**.
  - (1) For a period of 12 hours, emergency lighting
    - (A) At the stowage positions of life-saving appliances.
    - (B) At all escape routes such as alleyways, stairways, exits from accommodation and service spaces, embarkation points, etc.
    - (C) In the public spaces, if any.
    - (D) In the machinery spaces and main emergency generating spaces including their control positions.

- (E) In control stations.
  - (F) At the stowage positions for fireman's outfits, and
  - (G) At the steering gear.
  - (2) For a period of 12 hours
    - (A) The navigation lights and other lights required by the International Regulations for Preventing Collisions at Sea in force.
    - (B) Electrical internal communication equipment for announcements during evacuation.
    - (C) Fire detection and general alarm system and manual fire alarms, and
    - (D) Remote control devices of fire-extinguishing system, if electrical.
  - (3) For a period of 4 hours of intermittent operation
    - (A) The daylight signalling lamps, if they have no independent supply from their own accumulator battery, and
    - (B) The craft's whistle, if electrically driven.
  - (4) For a period of 12 hours
    - (A) The navigational equipment as required by chapter 13 of HSC code. Where such provision is unreasonable or impracticable, the Society may waive this requirement for craft of less than 5,000 tons gross tonnage,
    - (B) Essential electrically powered instruments and controls for propulsion machinery, if alternate sources of power are not available for such devices,
    - (C) One of the fire pumps required by **Pt 7, Ch 2, 201. 8,**
    - (D) The sprinkler pump and drencher pump, if fitted,
    - (E) The emergency bilge pump required by **Pt 5** and all the equipment essential for the operation of electrically powered remote controlled bilge valves, and
    - (F) Craft radio facilities and other loads as set out in 14.12.2 of HSC code.
  - (5) For a period of 10 minutes  
Power drives for directional control devices including those required to direct thrust forward and astern, unless there is a manual alternative acceptable to the Society.
2. The emergency source of electrical power in passenger craft is to be capable, having regard to starting currents and the transitory nature of certain loads, of supplying simultaneously at least the following services for the periods specified hereinafter, if they demand upon an electrical source for their operation and this requirement substitutes for **Pt 6, Ch 1, 203. 2 (2)** of **Rules for the Classification of Steel Ships**.
- (1) For category A craft, the emergency source of power is to be capable of supplying the following services simultaneously. **【See Guidance】**
    - (A) For a period of 5 hours, emergency lighting
      - (a) At the stowage positions of life-saving appliances,
      - (b) At all escape routes such as alleyways, stairways, exits from accommodation and service spaces, embarkation points, etc.
      - (c) In the public spaces,
      - (d) In the machinery spaces and main emergency generating spaces including their control positions,
      - (e) In control stations,
      - (f) At the stowage positions for firemen's outfits, and
      - (g) At the steering gear.
    - (B) For a period of 5 hours
      - (a) Main navigation lights, except for "not under command" lights,
      - (b) Electrical internal communication equipment required for announcements for passengers and crew during evacuation,
      - (c) Fire detection and general alarm system, and manual fire alarms, and
      - (d) Remote control devices of fire-extinguishing systems, if electrical.
    - (C) For a period of 4 hours of intermittent operation
      - (a) Daylight signalling lamps, if they have no independent supply from their own accumulator battery, and
      - (b) The craft whistle, if electrically driven.
    - (D) For a period of 5 hours
      - (a) Craft radio facilities and other loads as set out in 14.12.2 of HSC code, and
      - (b) Essential electrically powered instruments and controls for propulsion machinery, if alternate sources of power are not available for such devices.
    - (E) For a period of 12 hours

- The "not under command" lights.
- (F) For a period of 10 minutes  
Power drives for directional control devices including those required to direct thrust forward and astern, unless there is a manual alternative acceptable to the Society complying with 5.2.3 of HSC code.
- (2) For category B craft, the emergency source of power is to be capable of supplying the following services simultaneously
- (A) For a period of 12 hours, emergency lighting
- (a) At the stowage positions of life-saving appliances,
  - (b) At all escape routes such as alleyways, stairways, exits from accommodation and service spaces, embarkation points, etc,
  - (c) In the passenger compartments,
  - (d) In the machinery spaces and main emergency generating spaces including their control positions,
  - (e) In control stations,
  - (f) At the stowage positions for firemen's outfits, and
  - (g) At the steering gear.
- (B) For a period of 12 hours
- (a) The navigation lights and other lights required by the International Regulations for Preventing Collisions at Sea,
  - (b) Electrical internal communication equipment for announcements for passengers and crew required during evacuation,
  - (c) Fire detection and general alarm system and manual fire alarms, and
  - (d) Remote control devices of fire-extinguishing systems, if electrical.
- (C) For a period of 4 hours of intermittent operation
- (a) Daylight signalling lamps, if they have no independent supply from their own accumulator battery, and
  - (b) The craft whistle, if electrically driven
- (D) For a period of 12 hours
- (a) The navigational equipment as required by chapter 13 of HSC code. Where such provision is unreasonable or impracticable, the Society may waive this requirement for craft of less than 5,000 tons gross tonnage,
  - (b) Essential electrically powered instruments and controls for propulsion machinery, if alternate sources of power are not available for such devices,
  - (c) One of the fire pumps required by **Pt 7, Ch 2, 201. 8,**
  - (d) The sprinkler pump and drencher pump, if fitted,
  - (e) The emergency bilge pump required by Pt 5 and all the equipment essential for the operation of electrically powered remote controlled bilge valves, and
  - (f) Craft radio facilities and other loads as set out in 14.12.2 of HSC code.
- (E) For a period of 30 minutes  
Any watertight doors, required by chapter 2 of HSC code to be power operated, together with indicators and warning signals.
- (F) For a period of 10 minutes  
Power drives for directional control devices including those required to direct thrust forward and astern, unless there is a manual alternative acceptable to the Society complying with 5.2.3 of HSC code.
3. In addition to the emergency lighting required by 2 (1) (A) and (2) (A) above on every passenger craft with special category spaces
- (1) All passenger public spaces and alleyways are to be provided with supplementary electric lighting that can operate for at least 3 hours under any condition of heel when all other sources of electric power have failed. The illumination provided is to be such that the approach to the means of escape can be readily seen. The source of power for the supplementary lighting is to consist of accumulator batteries located within the lighting units that are continuously charged, where practicable, from the emergency switchboard. Alternatively, any other means of effective lighting may be accepted. Supplementary lighting is to be such that any lamp failure will be immediately apparent. Accumulator batteries are to be replaced at intervals having regard for the specified service life in the ambient service condition, and
  - (2) A portable rechargeable battery operated lamp is to be provided in every crew space alleyway, recreational space and every working space which is normally occupied unless supplementary

emergency lighting, as required by (1) above, is provided

4. Transitional sources of emergency electrical power are to comply with **Pt 6, Ch 1, 203. 4** of **Rules for the Classification of Steel Ships** and the following requirements instead of **Pt 6, Ch 1, 1404. (2) (B)** of the Rules.
  - (1) Power to operate the watertight doors, but not necessarily simultaneously, unless an independent temporary source of stored energy is provided. The power source is to have sufficient capacity to operate each door at least three times; i.e., closed – open – closed, against an adverse list of 15°; and
  - (2) Power to the control, indication and alarm circuits for the watertight doors for 30 minutes.
5. The emergency generator and its prime mover and any emergency accumulator battery are to be so designed and arranged as to ensure that they will function at full rated power when the craft is upright and when the craft has an expected list or trimming including damage cases in chapter 2 of HSC code, or is in any combination of angles within those limits.
6. As the substitute requirement for **Pt 6, Ch 1, 203. 1 (2)** of **Rules for the Classification of Steel Ships**, the emergency source of electrical power, associated transforming equipment, if any, transitional source of electrical power, emergency switchboard and emergency lighting switchboard are to be located above the waterline in the final condition of damage as referred to in chapter 2 of HSC code, operable in that condition and readily accessible. The location of the emergency source of electrical power, associated transforming equipment, if any, the transitional source of emergency power, the emergency switchboard and the emergency electrical lighting switchboards in relation to the main source of electrical power, associated transforming equipment, if any, and the main switchboard are to be such as to ensure that a fire or other casualty in spaces containing main source of electrical power, associated transforming equipment, if any, and the main switchboard or in any machinery space will not interfere with the supply, control and distribution of emergency electrical power.
7. Where the main source of electrical power is located in two or more compartments which are not contiguous, each of which has its own self-contained systems, including power distribution and control systems, completely independent of each other and such that a fire or other casualty in any one of the spaces will not affect the power distribution from the others, or to the services required by **Par 1** or **2 (1)** or **(2)**, the requirements of **Par 6** and **Pt 6, Ch 1, 203. 1 (1)** and **(4)** of **Rules for the Classification of Steel Ships** may be considered as met without an additional emergency source of electrical power, provided that
  - (1) There is at least one generating set, meeting the requirements of **Par 5** above and each with sufficient capacity to meet the requirements of **Par 1** or **2 (1)** or **(2)**, in each of at least two non-contiguous spaces,
  - (2) The arrangements required by (1) above in each such space are equivalent to those required by **Pt 6, Ch 1, 203. 3 (1)**, **5** and **6 (1)** to **(3)** of **Rules for the Classification of Steel Ships** so that a source of electrical power is available at all times to the services required by **Par 1** or **2 (1)** or **(2)** and by **Par 7** and
  - (3) The generator sets referred to in (1) above and their self-contained systems are installed in accordance with **Par 6**.

### 203. Stabilization system of craft [See Guidance]

1. Where stabilization system of a craft is essentially dependent on one device as with a single rudder or pylon, which is itself dependent on the continuous availability of electric power, it should be served by at least two independent circuits, one of which is to be fed either from the emergency source of electric power or from an independent power source located in such a position as to be unaffected by fire or flooding affecting the main source of power. Failure of either supply is not to cause any risk to the craft or passengers during switching to the alternative supply and such switching arrangements are to meet the requirements in 5.2.5 of HSC code. These circuits are to be provided with short circuit protection and an overload alarm.
2. Protection against excess current may be provided, in which case it is to be for not less than twice the full load current of the motor or circuit so protected, and is to be arranged to accept the appropriate starting current with a reasonable margin. Where three-phase supply is used, an alarm is to be provided in a readily observed position in the craft's operating compartment that will indicate failure of any one of the phases.

3. Where such systems are not essentially dependent on the continuous availability of electric power but at least one alternative system, not dependent on the electric supply is installed, then the electrically powered or controlled system may be fed by a single circuit protected in accordance with **Par 2**.
4. The requirements of chapters 5 and 16 of HSC code for power supply of the directional control system and stabilization system of the craft are to be met. ↓

## CHAPTER 2 CONTROL SYSTEMS

### Section 1 General

#### 101. Application

1. Requirements for electrical equipment not specified in this chapter are, in principle, to be in accordance with **Rules for the Classification of Steel Ships**.
2. In case of high speed craft engaged on international voyages, the HSC code is to be applied.  
【See Guidance】

### Section 2 Automatic and Remote Control Systems

#### 201. Control center of craft 【See Guidance】

1. A control center is to be arranged from which control and surveillance of the craft can be exercised both under normal conditions and in an emergency.
2. Controls and indicating instruments are to be provided for the following functions
  - Steering
  - Propulsive power
  - Fire extinguishing primary system
  - Ventilation fans
  - Ventilation dampers against fire
  - Fuel oil pumps and fuel quick closing valves
  - Bilge system in machinery spaces
  - Alarms

#### 202. Stabilization control system

1. In case of failure of any automatic equipment or stabilization device, or its power drive, the parameters of craft motion are to remain within safe limits.
2. Craft fitted with an automatic stabilization system are to be provided with an automatic safety control unless redundancy in the system provides equivalent safety. Where an automatic safety control is fitted, provision is to be made to override it and to cancel the override from the main control position.
3. The parameters and the levels at which any automatic safety control is to give the command to decrease speed and put the craft safely into the displacement or other safe mode are to be chosen with regard to the safe values of heel, trim, yaw and a combination of trim and draught appropriate to the particular craft and service such as the possible consequences of power failure for propulsion, lift or stabilization devices.
4. The parameters and the degree of stabilization of the craft provided by the automatic stabilization system are to be chosen with due regard to the purpose and service conditions of the craft. ↓

**PART 7**  
**FIRE PROTECTION, DETECTION AND**  
**EXTINCTION**



## CHAPTER 1 FIRE PROTECTION

### Section 1 General

#### 101. Application

1. Requirements for fire protection not specified in this chapter are, in principle, to be in accordance with **Pt 8, Ch 1 of Rules for the Classification of Steel Ships**.
2. For crafts not engaged on international voyages, those crafts are to comply with relevant governmental regulation.

#### 102. Definitions

1. Fire-resisting divisions are those divisions formed by bulkheads and decks which comply with the following.
  - (1) They are to be constructed of non-combustible or fire-restricting materials.
  - (2) They are to be suitably stiffened.
  - (3) They are to be constructed so as to be capable of preventing the passage of smoke and flame up to the end of the appropriate fire protection time.
  - (4) Where required, they are to maintain load-carrying capabilities up to the end of the appropriate fire protection time.
  - (5) They are to have thermal properties such that the average temperature on the unexposed side will not rise more than 139°C above the original temperature, nor will the temperature, at any one point, including any joint, rise more than 180°C above the original temperature during the appropriate fire protection time.
2. Fire-restricting materials are those materials which have properties complying with the following.
  - (1) Low flame-spread characteristics,
  - (2) Limited heat flux, due regard being paid to the risk of ignition of furniture in the compartment,
  - (3) Limited rate of heat release, due regard being paid to the risk of spread of fire to an adjacent compartment, and
  - (4) Gas and smoke are not to be emitted in quantities that could be dangerous to the occupants of the craft.
3. Auxiliary machinery spaces are spaces containing internal-combustion engines with power output up to and including 110 kW driving generators, sprinkler, drencher or fire pumps, bilge pumps, etc., oil filling stations, switchboards of aggregate capacity exceeding 800 kW, similar spaces and trunks to such spaces.
4. Auxiliary machinery spaces having little or no fire risk are spaces such as refrigerating, stabilizing, ventilation and air-conditioning machinery, switchboards of aggregate capacity 800 kW or less, similar spaces and trunks to such spaces.
5. Control stations are those spaces in which the craft's radio or navigating equipment or the emergency source of power and emergency switchboard are located, or where the fire recording or fire control equipment is centralized, or where other functions essential to the safe operation of the craft, such as propulsion control, public address, stabilization systems, etc., are located.
6. Category A craft is any high-speed passenger craft
  - (1) Operating on a route where it has been demonstrated to the satisfaction of the flag and port States that there is a high probability that, in the event of an evacuation at any point on the route, all passengers and crew can be rescued safely within the least of
    - the time to prevent persons in survival craft from exposure causing hypothermia in the worst conditions,
    - the time appropriate with respect to environmental conditions and geographical features of the route, or
    - 4 hours, and
  - (2) carrying not more than 450 passengers.

7. Category B craft is any high-speed passenger craft, other than a category A craft, with machinery and safety systems arranged such that, in the event of damage disabling any essential machinery and safety systems in one compartment, the craft retains the capability to navigate safely.

### 103. General requirements

1. The use of fuel with a flashpoint below 43°C is not recommended. However, fuel with a lower flashpoint, but not lower than 35°C, may be used in gas turbines subject to compliance with the requirements in **206**.
2. Craft repair and maintenance is to be carried out in accordance with the requirements given in chapters 18 and 19 of the HSC Code.
3. Enclosed spaces such as cinemas, discotheques, and similar spaces are not permitted. Refreshment kiosks which do not contain cooking facilities with exposed heating surfaces may be permitted. Galleys, if fitted, are to be in full compliance with Reg. II-2 of SOLAS.
4. Dangerous goods may be carried, provided they are in compliance with the relevant provisions of Reg. II-2/19 SOLAS.

## Section 2 Structural Fire Protection

### 201. Classification of space use and structural fire protection times **[See Guidance]**

The application for **Table 7.1.1** and **Table 7.1.2** specifying the structural fire protection times for separating bulkheads and decks is to be in accordance with the following grouping of space use. However, the title of each category is intended to be typical rather than restricted.

- (1) Areas of major fire hazard include the following spaces:
  - Machinery spaces
  - Spaces containing dangerous goods
  - Special category spaces and ro-ro spaces
  - Store-rooms containing flammable liquids
  - Galleys
  - Sales shops having a deck area of 50 m<sup>2</sup> or greater and containing flammable liquids for sale
  - Trunks in direct communication with the above spaces.
- (2) Areas of moderate fire hazard include the following spaces:
  - Auxiliary machinery spaces, as defined in **102. 3**.
  - Bond stores containing packaged beverages with alcohol content not exceeding 24 % by volume
  - Service spaces
  - Crew accommodations containing sleeping berths
  - Sales shops having a deck area of less than 50 m<sup>2</sup> containing a limited amount of flammable liquids for sale and where no dedicated store is provided separately
  - Sales shops having a deck area of 50 m<sup>2</sup> or greater not containing flammable liquids
  - Trunks in direct communication with the above spaces.
- (3) Areas of minor fire hazard include the following spaces: **[See Guidance]**
  - Auxiliary machinery spaces, as defined in **102. 4**.
  - Cargo spaces
  - Fuel tank compartments
  - Public spaces and refreshment kiosks **[See Guidance]**
  - Tanks, voids and areas of little or no fire risk
  - Sales shops other than those specified in (1) and (2)
  - Corridors in passenger areas and stairway enclosures
  - Crew accommodation other than that mentioned in above (2)
  - Trunks in direct communication with the above spaces.
- (4) Control stations are as defined in **102. 6**.
- (5) Evacuation stations and external escape routes include the following areas:
  - External stairs and open decks used for escape routes
  - Muster stations, internal and external

- Open deck spaces and enclosed promenades forming lifeboat and liferaft embarkation and lowering stations
  - The craft's side to the waterline in the lightest seagoing condition, superstructure and deck-house sides situated below and adjacent to liferaft's and evacuation slide's embarkation areas
- (6) Open spaces include the following areas:
- Open space locations other than evacuation stations and external escape routes and control stations.

**Table 7.1.1 Structural Fire Protection Times for Separating Bulkheads and Deck of Passenger Craft**

		A	B	C	D	E	F
Areas of major fire hazard	A	60 <sub>1,2</sub>	30	3	3,4	3	-
		60 <sub>1,2</sub>	60 <sub>1</sub>	60 <sub>1,8</sub>	60 <sub>1</sub>	60 <sub>1</sub>	60 <sub>1,7,9</sub>
Areas of moderate fire hazard	B		30 <sub>2</sub>	3	3,4	3	-
			30 <sub>2</sub>	30 <sub>8</sub>	60	30	3
Areas of minor fire hazard	C			3	3,4	3	-
				3	30 <sub>8,10</sub>	3	3
Control stations	D				3,4	3	-
					3,4	3,4	3
Evacuation stations and escape routes	E					3	-
						3	3
Open spaces	F						-

**NOTES:**

The figures on either side of the diagonal line represent the required structural fire protection time for the protection system on the relevant side of the division. The small note numbers are as specified below:

1. the upper side of the decks of special category spaces need not be insulated.
2. Where adjacent spaces are in the same alphabetical category and a note 2 appears, a bulkhead or deck between such spaces need not be fitted if deemed unnecessary by the Society. For example, a bulkhead need not be required between two store-rooms. A bulkhead is, however, required between a machinery space and a special category space even though both spaces are in the same category.
3. No structural fire protection requirements. However, smoke-tight non-combustible or fire-restricting material is required.
4. Control stations which are also auxiliary machinery spaces are to be provided with 30 minutes structural fire protection.
5. There are no special requirements for material or integrity of boundaries where only a dash appears in the tables.
6. The fire protection time is 0 minute and the time for prevention of passage of smoke and flame is 30 minutes as determined by the first 30 minutes of the standard fire test.
7. When steel construction is used, fire-resisting divisions need not comply with **102. 1. (5)**.
8. When steel construction is used, fire-resisting divisions adjacent to void spaces need not comply with **102. 1. (5)**.
9. The fire protection time may be reduced to 0 min for those parts of open ro-ro spaces which are not essential parts of the craft's main load bearing structure, where passengers have no access to them and the crew need not have access to them during any emergency.
10. On category A craft, this value may be reduced to 0 min where the craft is provided with only a single public space (excluding lavatories) protected by a sprinkler system and adjacent to the operating compartment.

**Table 7.1.2 Structural Fire Protection Times for Separating Bulkheads and Deck of Cargo Craft**

	A	B	C	D	E	F
Areas of major fire hazard	A 60 <sub>1,2</sub> / 60 <sub>1,2</sub>	B 60 <sub>1</sub> / 30	C 60 <sub>1,8</sub> / 3	D 60 <sub>1</sub> / 3,4	E 60 <sub>1</sub> / 3	F 60 <sub>1,7,9</sub> / -
Areas of moderate fire hazard	B 60 <sub>1</sub>	B 6,2	C 3	D 60 / 3,4	E 3	F -
Areas of minor fire hazard	C 3	C 3	C 3	D 30 <sub>8</sub> / 3,4	E 3	F 3
Control stations	D 3,4	D 3,4	D 3,4	D 3,4	E 3	F 3
Evacuation stations and escape routes	E 3	E 3	E 3	E 3	E 3	F 3
Open spaces	F -	F -	F -	F -	F -	F -
NOTES: Refer to notes of <b>Table 7.1.1</b> .						

## 202. Structure

1. The requirements below apply to all craft irrespective of construction material. The structural fire protection times for separating bulkheads and decks are to be in accordance with **Table 7.1.1** and **7.1.2**, and the structural fire protection times are all based on providing protection for a period of 60 minutes as referred to in 4.8.1 of HSC code. If any other lesser structural fire protection time is determined for category A craft and cargo craft by 4.8.1 of HSC code, than the times given in **203. 2** and **3** may be amended pro-rata. In no case should the structural fire protection time be less than 30 minutes. **[See Guidance]**
2. The hull, superstructure, structural bulkheads, decks, deckhouses and pillars are to be constructed of approved non-combustible materials having adequate structural properties. The use of other fire-restricting materials may be permitted as in compliance with the requirements of this chapter.

## 203. Fire-resisting divisions **[See Guidance]**

1. Areas of major and moderate fire hazard are to be enclosed by fire-resisting divisions except where the omission of any such division would not affect the safety of the craft. These requirements need not apply to those parts of the structure in contact with water at the lightweight condition, but due regard is to be given to the effect of temperature of hull in contact with water and to heat transfer from any uninsulated structure in contact with water to the insulated structure above water.
2. Fire resisting bulkheads and decks are to be constructed to resist exposure to the standard fire test for a period of 30 minutes in areas of moderate fire hazard, and for 60 minutes in areas of major fire hazards except as provided in **202. 1**.
3. Main load-carrying structures within major and moderate fire hazard areas are to be arranged to distribute load such that there will be no collapse of the construction of the hull and superstructure when it is exposed to fire during the appropriate fire protection time. The load-carrying structure is also to comply with the requirements of **Par 4** and **5** below.
4. If the structures specified in **Par 2** are made of aluminium alloy, their installation is to be such that the temperature of the core does not rise more than 200 °C above the ambient temperature in accordance with the times given in **202. 1** and **203. 2**.
5. If the structures specified in **Par 3** are made of combustible material, their installation is to be such that their temperatures will not rise to a level where deterioration of the construction will occur during exposure to the composite standard fire test to such an extent that the load-carrying capability, in accordance with the times given in **202. 1** and **203. 2**, will be impaired.

6. The construction of all doors, and door frames in fire-resisting divisions, with the means of securing them when closed, is to provide resistance to fire as well as to the passage of smoke and flame equivalent to that of the bulkheads in which they are situated. Watertight doors of steel need not be insulated. Where a fire-resisting division is penetrated by pipes, ducts, controls, electrical cables or for other purposes, arrangements and necessary testing are to be made to ensure that the fire-resisting integrity of the division is not impaired. **【See Guidance】**

#### 204. Restricted use of combustible materials

1. All separating divisions, ceilings or linings if not a fire-resisting division, are to be of non-combustible or fire-restricting materials.
2. Where insulation is installed in areas in which it could come into contact with any flammable fluids or their vapours, its surface is to be impermeable to such flammable fluids or vapours. The exposed surfaces of vapour barriers and adhesives used in conjunction with insulation materials are to have low flame-spread characteristics.
3. Furniture and furnishings in public spaces and crew accommodation are to comply with the following standards:
  - (1) All case furniture is to be constructed of approved non-combustible or fire-restricting materials, except that a combustible veneer with a calorific value not exceeding  $45 \text{ MJ/m}^2$  may be used on the exposed surface of such articles;
  - (2) All other furniture such as chairs, sofas and tables are to be constructed with frames of non-combustible or fire-restricting materials;
  - (3) All draperies, curtains and other suspended textile materials are to be of approved materials and have qualities of resistance to the propagation of flame.
  - (4) All upholstered furniture and all bedding components are to be of approved materials and have qualities of resistance to the ignition and propagation of flame.
  - (5) All deck finish materials are of approved materials.
4. The following surfaces are, as a minimum standard, to be constructed of materials having low flame-spread characteristics **【See Guidance】**
  - (1) Exposed surfaces in corridors and stairway enclosures, and of bulkheads, wall and ceiling linings in all accommodation and service spaces and control stations,
  - (2) Concealed or inaccessible spaces in accommodation, service spaces and control stations.
5. Any thermal and acoustic insulation material, if not fire-resisting division or fire-resisting material, is to be of non-combustible material.
6. Materials used in the craft, when exposed to fire, are not to emit smoke or toxic gases in quantities that could be dangerous to humans.
7. Void compartments, where low density combustible materials are used to provide buoyancy, are to be protected from adjacent fire hazard areas by fire-resisting divisions, in accordance with **Table 7.1.1** and **7.1.2**. Also, the space and its closures are to be gastight, but it is to be ventilated to atmosphere. **【See Guidance】**
8. In compartments where smoking is allowed, suitable non-combustible ash containers are to be provided. In compartments where smoking is not allowed, adequate notices are to be displayed.
9. The exhaust gas pipes are to be arranged so that the risk of fire is kept to a minimum. To this effect, the exhaust system is to be insulated and all the compartments and structures which are contiguous with the exhaust system, or those which may be affected by increased temperatures caused by waste gases in normal operation or in an emergency, are to be constructed of non-combustible material or be shielded and insulated with non-combustible material to protect from high temperatures.
10. The design and arrangement of the exhaust manifolds or pipes are to be such as to ensure the safe discharge of exhaust gases.

#### 205. Arrangement

1. Internal stairways which serve more than two decks of accommodation are to be enclosed at all

levels with smoke-tight divisions of non-combustible or fire-restricting materials, and where only two decks are served, such enclosures are to be provided on at least one level. Stairways may be fitted in the open in a public space, provided they are wholly within public space. **[See Guidance]**

2. Lift trunks are to be fitted so as to prevent the passage of smoke and flame from one deck to another, and are to be provided with a means of closing to permit the control of draught and smoke.
3. In accommodation and service spaces, control stations, corridors and stairways air spaces enclosed behind ceilings, panelling or linings are to be suitably divided by close fitting draught stops not more than 14 m apart. **[See Guidance]**

## 206. Fuel and other flammable fluid tanks and systems

1. Tanks containing fuel and other flammable fluids are to be separated from passenger, crew, and baggage compartments by suitably ventilated and drained vapour-proof enclosures or cofferdams.
2. Fuel oil tanks are not to be located in or contiguous to major fire hazard areas. However, flammable fluids of a flashpoint not less than 60°C may be located within such areas provided the tanks are made of steel or other equivalent material.
3. Every oil fuel pipe which, if damaged, would allow oil to escape from a storage, settling or daily service tank is to be fitted with a cock or valve directly on the tank capable of being closed from a position outside the space concerned in the event of a fire occurring in the space in which such tanks are situated.
4. Pipes, valves and couplings conveying flammable fluids are to be of steel or such alternative material permitted by the Society, in respect of strength and fire integrity having regard to the service pressure and the spaces in which they are installed. Wherever practicable, the use of flexible pipes is to be avoided.
5. Pipes, valves and couplings conveying flammable fluids are to be arranged as far from hot surfaces or air intakes of engine installations, electrical appliances and other potential sources of ignition as is practicable and be located or shielded so that the likelihood of fluid leakage coming into contact with such sources of ignition is kept to a minimum.
6. Fuel with a flashpoint below 35°C is not to be used. In every craft in which fuel with a flashpoint below 43°C is used, the arrangements for the storage, distribution and utilization of the fuel are to be such that, having regard to the hazard of fire and explosion which the use of such fuel may entail, the safety of the craft and of persons on board is preserved. In addition to the requirements of **Pars 1 to 5**, the arrangements are to comply with the following:
  - (1) Tanks for the storage of such fuel are to be located outside any machinery space and at a distance of not less than 760 mm inboard from the shell side and bottom plating, and from decks and bulkheads,
  - (2) Arrangements are to be made to prevent overpressure in any fuel tank or in any part of the oil fuel system, including the filling pipes. Any relief valves and air or overflow pipes are to discharge to a safe position,
  - (3) The spaces in which fuel tanks are located are to be mechanically ventilated using exhaust fans providing not less than six air changes per hour. The fans are to be such as to avoid the possibility of ignition of flammable gas air mixtures. Suitable wire mesh guards are to be fitted over inlet and outlet ventilation openings. The outlets for such exhausts are to be discharged to a safe position. 'No Smoking' signs are to be posted at the entrances to such spaces,
  - (4) Earthed electrical distribution systems are not to be used, with the exception of earthed intrinsically safe circuits,
  - (5) Suitable certified safe type electrical equipment is to be used in all spaces where fuel leakage could occur, including ventilation system. Only electrical equipment and fittings essential for operational purposes are to be fitted in such spaces.

## 207. Ventilation

1. The main inlets and outlets of all ventilation systems are to be capable of being closed from outside the spaces being ventilated. In addition, such openings to areas of major fire hazard are to be capable of being closed from a continuously manned control station.

2. All ventilation fans are to be capable of being stopped from outside the spaces which they serve, and from outside the spaces in which they are installed. Ventilation fans serving major fire hazard areas are to be capable of being operated from a continuously manned control station. The means provided for stopping the power ventilation to the machinery space are to be separated from the means provided for stopping ventilation of other spaces. **[See Guidance]**
3. Major fire hazard areas and main passenger spaces serving as muster stations are to have separate ventilation systems and ventilation ducts. Ventilation ducts for major fire hazard areas are not to pass through other spaces, and ducts for ventilation of other spaces are not to pass through major fire hazard areas. Ventilation outlets from areas of major fire hazard are not to terminate within a distance of 1 m from any control station, evacuation station or external escape route. In addition, exhaust ducts from galley ranges are to be fitted with:
  - (1) Grease trap readily removable for cleaning unless an alternative approved grease removal system is fitted;
  - (2) Fire damper located in the lower end of the duct which is automatically and remotely operated, and in addition a remotely operated fire damper located in the upper end of the duct;
  - (3) Fixed means for extinguishing a fire within the duct;
  - (4) Remote control arrangements for shutting off the exhaust fans and supply fans, for operating the fire dampers mentioned in (2) and for operating the fire-extinguishing system, which is to be placed in a position close to the entrance to the galley. Where a multi-branch system is installed, means are to be provided to close all branches exhausting through the same main duct before an extinguishing medium is released into the system; and
  - (5) Suitably located hatches for inspection and cleaning.
4. Where, of necessity, a ventilation duct passes through a fire-resisting or smoke-tight division, a fail safe automatic closing fire damper is to be fitted adjacent to the division. The duct between the division and the damper is to be of steel or other equivalent material and insulated to the same standard as required for the fire-resisting division.
5. Where ventilation systems penetrate decks, the arrangements are to be such that the effectiveness of the deck in resisting fire is not thereby impaired and precautions are to be taken to reduce the likelihood of smoke and hot gases passing from one deck space to another through the system.
6. All dampers fitted on fire-resisting or smoke-tight divisions are also to be capable of being manually closed from each accessible side of the division in which they are fitted, and remotely closed from the continuously manned control station.
7. Ducts are to be made of non-combustible or fire restricting material. Short ducts, however, may be of combustible materials subject to the following conditions:
  - (1) Their cross-section does not exceed 0.02 m<sup>2</sup> ;
  - (2) Their length does not exceed 2 m;
  - (3) They may only be used at the terminal end of the ventilation system;
  - (4) They are not to be situated less than 600 mm from an opening in a fire-resisting or fire-restricting division; and
  - (5) Their surfaces have low flame spread characteristics.

#### 208. Protection of special category spaces and ro-ro spaces

Boundaries of special category spaces and ro-ro spaces are to be insulated in accordance with **Tables 7.1.1** and **7.1.2**. Indicators are to be provided on the navigating bridge which are to indicate when any door leading to or from the special category space and ro-ro spaces is closed.

#### 209. Openings in fire-resisting divisions **[See Guidance]**

1. Except for the hatches between cargo, special category, store, and baggage spaces and between such spaces and the weather decks, all openings are to be provided with permanently attached means of closing which are to be at least as effective for resisting fires as the divisions in which they are fitted.
2. It is to be possible for each door to be opened and closed from each side of the bulkhead by one person only. **[See Guidance]**
3. Fire doors bounding major fire hazard areas and stairway enclosures are to satisfy the following

requirements.

- (1) The doors are to be self-closing and be capable of closing with an angle of inclination of up to 3.5° opposing closure, and are to have an approximately uniform rate of closure of no more than 40 seconds and no less than 10 seconds with the craft in the upright position. The approximate uniform rate of closure for sliding fire doors is to be of no more than 0.2 m/s and no less than 0.1 m/s with the craft in the upright position.
  - (2) Remote-controlled sliding or power-operated doors are to be equipped with an alarm that sounds at least 5 seconds but not more than 10 seconds before the door begins to move and continue sounding until the door is completely closed. Doors designed to reopen upon contacting an object in their paths are to reopen sufficiently to allow a clear passage of at least 0.75 m, but no more than 1 m.
  - (3) All doors are to be capable of remote and automatic release from a continuously manned central control station, either simultaneously or in groups, and also individually from a position at both sides of the door. Indication is to be provided at the fire control panel in the continuously manned control station whether each of the remote-controlled doors is closed. The release mechanism is to be so designed that the door will automatically close in the event of disruption of the control system or central power supply. Release switches are to have an on-off function to prevent automatic resetting of the system. Hold-back hooks not subject to control station release are to be prohibited.
  - (4) Local power accumulators for power-operated doors are to be provided in the immediate vicinity of the doors to enable the doors to be operated at least 10 times (fully opened and closed) using the local controls.
  - (5) Double-leaf doors equipped with a latch necessary to their fire integrity are to have a latch that is automatically activated by the operation of the doors when released by the system.
  - (6) Doors giving direct access to special category spaces which are power-operated and automatically closed need not be equipped with alarms and remote-release mechanisms required (2) and (3) above.
  - (7) A door closed remotely from the continuously manned control station is to be capable of being re-opened at both sides of the door by local control. After such local opening, the door is automatically to close again.
  - (8) Disruption at one door of the control system or main source of electric power is not to impair the safe functioning of the other doors.
  - (9) The components of the local control system is to be accessible for maintenance and adjusting.
  - (10) Power operated doors are to be provided with a control system of an approved type which is to be able to operate in case of fire, this being determined in accordance with the Fire Test Procedures Code. This system is to satisfy the following requirements:
    - (A) the control system is to be able to operate at a temperature of at least 200°C for at least 60 min, served by the power supply;
    - (B) the power supply for all other doors not subject to fire is to not be impaired; and
    - (C) at temperatures exceeding 200°C the control system is to be automatically isolated from the power supply and shall be capable of keeping the door closed up to at least 945°C.
4. The requirements for integrity of fire-resisting divisions of the outer boundaries facing open spaces of a craft are not to apply to glass partitions, windows and side scuttles. Similarly, the requirements for integrity of fire-resisting divisions facing open spaces are not to apply to exterior doors in superstructures and deckhouses.
5. Doors in smoke-tight divisions are to be self-closing. Doors which are normally kept open are to close automatically or by remote control from a continuously manned control station.



## Section 3 Additional Requirements for High Speed Passenger Craft

### 301. Arrangement

1. For category B craft, the public spaces are to be divided into zones according to the following.

**[See Guidance]**

- (1) The craft is to be divided into at least two zones. The mean length of each zone is not to exceed 40 m.
  - (2) For the occupants of each zone there is to be an alternative safe area to which it is possible to escape in case of fire. The alternative safe area is to be separated from other passenger zones by smoke-tight divisions of non-combustible materials or fire-restricting materials extending from deck to deck. The alternative safe area can be another passenger zone provided the additional number of passengers may be accommodated in an emergency.
  - (3) The alternative safe area is to, as far as practicable, be located adjacent to the passenger zone it is intended to serve. There are to be at least two exits from each passenger zone, located as far away from each other as possible, leading to the alternative safe area. Escape routes are to be provided to enable all passengers and crew to be safely evacuated from the alternative safe area.
2. Category A craft need not be divided into zones.
  3. Control stations, life-saving appliance stowage positions, escape routes and places of embarkation into survival craft are not, as far as practicable, to be located adjacent to any major or moderate fire hazard areas.

### 302. Ventilation

The ventilation fans of each zone in the accommodation spaces are also to be capable of being independently controlled from a continuously manned control station.

## Section 4 Additional Requirements for High Speed Cargo Craft

### 401. Control station

Control stations, life-saving appliances stowage positions, escape routes and places of embarkation into survival craft are to be located adjacent to crew accommodation areas.

### 402. Cargo Spaces

Cargo spaces, except open deck areas or refrigerated holds, are to be provided with an approved automatic smoke-detection system and protected by an approved fixed quick-acting fire-extinguishing system operable from the control station.

## Section 5 Additional Requirements for Craft and Cargo Spaces intended for the Carriage of Dangerous Goods

### 501. Application

For crafts intended for the carriage of dangerous goods and engaged on international voyage, the HSC Code is to be applied. ↓

## CHAPTER 2 FIRE DETECTION AND EXTINCTION

### Section 1 General

#### 101. Application

1. The requirements of this chapter, in principle, apply to the crafts to which the Ship's Safety Law of Korea do not apply.
2. Other requirements for fire detection and extinction not specified in this chapter are, in principle, to be in accordance with **Pt 8 of Rules for the Classification of Steel Ships**.
3. For crafts not engaged on international voyages, the requirements in this chapter may be used as appropriate but the crafts are to be equipped with necessary equipment to prevent occurrence and spread of fire.

#### 102. General requirements

Where a fire is detected, the crew immediately puts into action the fire-fighting procedures, informs the base port of the accident and prepares for the escape of passengers to alternative safe area or compartment, or, if necessary, for the evacuation of passengers.

### Section 2 Fire Detection and Extinction

#### 201. Fire detection and extinguishing systems

1. Areas of major and moderate fire hazard and other enclosed spaces not regularly occupied within public spaces and crew accommodation, such as toilets, stairway enclosures, corridors and escape routes are to be provided with an approved automatic smoke detection system and manually operated call points to indicate at the control station the location of outbreak of a fire in all normal operating conditions of the installations. Detectors operated by heat instead of smoke may be installed in galleys. Main propulsion machinery room(s) is to, in addition, have detectors sensing other than smoke and be supervised by TV cameras monitored from the operating compartment. Manually operated call points are to be installed throughout the public spaces, crew accommodation, corridors and stairway enclosures, service spaces and where necessary control stations. One manually operated call point is to be located at each exit from these spaces and from areas of major fire hazard.
2. The fixed fire detection and fire alarm systems are to comply with the following.
  - (1) General requirements
    - (A) Any required fixed fire detection and fire alarm system with manually operated call points are to be capable of immediate operation at all times.
    - (B) Power supplies and electric circuits necessary for the operation of the system are to be monitored for loss of power or fault conditions as appropriate. Occurrence of a fault condition is to initiate a visual and audible fault signal at the control panel which is to be distinct from a fire signal.
    - (C) Not less than two sources of power supply for the electrical equipment used in the operation of the fixed fire detection and fire alarm systems, one of which is an emergency source. The supply is to be provided by separate feeders reserved solely for that purpose. Such feeders are to run to an automatic change-over switch situated in, or adjacent to, the control panel for the fire detection system.
    - (D) Detectors and manually operated call points are to be grouped into sections. The activation of any detector or manually operated call point is to initiate a visual and audible fire signal at the control panel and indicating units. If the signals have not received attention within two minutes, an audible alarm is to be automatically sounded throughout the crew accommodation and service spaces, control stations and machinery spaces. There is to be no time delay for the audible alarms in crew accommodation areas when all the control stations are unattended. The alarm sounder system need not be an integral part of the detection system.

- (E) The control panel is to be located in the operating compartment or in the main fire control station.
- (F) Indicating units are, as a minimum, to denote the section in which a detector or manually operated call point has operated. At least one unit is to be so located that it is easily accessible to responsible members of the crew at all times, when at sea or in port, except when the craft is out of service. One indicating unit is to be located in the operating compartment if the control panel is located in the space other than the operating compartment.
- (G) Clear information is to be displayed on or adjacent to each indicating unit about the spaces covered and the location of the sections.
- (H) Where the fire-detection system does not include means of remotely identifying each detector individually, no section covering more than one deck within public spaces, crew accommodation, corridors, service spaces and control stations is normally to be permitted except a section which covers an enclosed stairway. In order to avoid delay in identifying the source of fire, the number of enclosed spaces included in each section is to be limited. In no case is to more than 50 enclosed spaces be permitted in any section. If the detection system is fitted with remotely and individually identifiable fire detectors, the sections may cover several decks and serve any number of enclosed spaces.
- (I) In passenger craft, if there is no fire detection system capable of remotely and individually identifying each detector, a section of detectors is not to serve spaces on both sides of the craft nor on more than one deck and neither should it be situated in more than one zone according to **Ch 1, 301. 1**, if it is satisfied that the protection of the craft against fire will not thereby be reduced, may permit such a section of detectors to serve both sides of the craft and more than one deck. In passenger craft fitted with individually identifiable fire detectors, a section may serve spaces on both sides of the craft and on several decks.
- (J) A section of fire detectors which covers a control station, a service space, a public space, crew accommodation, corridor or stairway enclosure is not to include a machinery space of major fire hazard.
- (K) Detectors are to be operated by heat, smoke or other products of combustion, flame, or any combination of these factors. Detectors operated by other factors indicative of incipient fires may be considered by the Society provided that they are no less sensitive than such detectors. Flame detectors are only to be used in addition to smoke or heat detectors.
- (L) Suitable instructions and component spares for testing and maintenance are to be provided.
- (M) The function of the detection system is to be tested periodically by means of equipment producing hot air at the appropriate temperature, or smoke or aerosol particles having the appropriate range of density or particle size or other phenomena associated with incipient fires to which the detector is designed to respond. All detectors are to be of a type such that they can be tested for correct operation and restored to normal surveillance without the renewal of any component.
- (N) The fire detection system is not to be used for any other purpose, except that closing of fire doors and similar functions may be permitted at the control panel.
- (O) Fire detection systems with a zone address identification capability are to be so arranged that.
  - (a) A loop cannot be damaged at more than one point by a fire, **[See Guidance]**
  - (b) Means are provided to ensure that any fault (e.g., power break; short circuit; earth) occurring in the loop is not to render the whole loop ineffective, **[See Guidance]**
  - (c) All arrangements are made to enable the initial configuration of the system to be restored in the event of failure (electrical, electronic, informatic), and
  - (d) The first initiated fire alarm is not to prevent any other detector to initiate further fire alarms.
- (2) Installation requirements
  - (A) Manually operated call points are to be readily accessible in the corridors of each deck such that no part of the corridor is more than 20 m from a manually operated call point.
  - (B) Where a fixed fire detection and fire alarm system is required for the protection of spaces other than stairways, corridors and escape routes, at least one detector complying with (1), (K) is to be installed in each such space.
  - (C) Detectors are to be located for optimum performance. Positions near beams and ventilation ducts or other positions where patterns of air flow could adversely affect performance and positions where impact or physical damage is likely are to be avoided. In general, detectors which are located on the overhead are to be a minimum distance of 0.5 m away from

bulkheads.

- (D) The maximum spacing of detectors is to be in accordance with the table below.

Type of detector	Maximum floor area per detector	Maximum distance apart between centres	Maximum distance away from bulkheads
Heat	37 m <sup>2</sup>	9 m	4.5 m
Smoke	74 m <sup>2</sup>	11 m	5.5 m

The Society may require or permit other spacings based upon test data which demonstrate the characteristics of the detectors.

- (E) Electrical wiring which forms part of the system is to be so arranged as to avoid machinery spaces of major fire hazard, and other enclosed spaces of major fire hazard except, where it is necessary, to provide for fire detection of fire alarm in such spaces or to connect to the appropriate power supply.

(3) Design requirements

- (A) The system and equipment is to be suitably designed to withstand supply voltage variation and transients, ambient temperature changes, vibration, humidity, shock, impact and corrosion normally encountered in crafts.
- (B) Smoke detectors required by (2), (B) above are to be certified to operate before the smoke density exceeds 12.5 % obscuration per metre, but not until the smoke density exceeds 2 % obscuration per metre. Smoke detectors to be installed in other spaces are to operate within sensitivity limits to the satisfaction of the Society having regard to the avoidance of detector insensitivity or oversensitivity.
- (C) Heat detectors are to be certified to operate before the temperature exceeds 78°C but not until the temperature exceeds 54°C, when the temperature is raised to those limits at a rate less than 1°C per minute. At higher rates of temperature rise, the heat detector is to operate within temperature limits, having regard for the avoidance of detector insensitivity or over-sensitivity.
- (D) The permissible temperature for the operation of heat detectors may be increased to 30°C above the maximum deckhead temperature in drying rooms and similar spaces of a normal high ambient temperature.
- (E) Flame detectors referred to in (1), (K) are to have a sensitivity sufficient to determine flame against an illuminated space background and a false signal identification system.

3. A fixed fire detection and fire alarm system for periodically unattended machinery spaces (including machinery spaces in which watchkeeping personnel is not in place continuously or in which personnel location is impossible due to narrow structures under the Society's consideration, hereinafter the same applies) is to comply with the following.

- (1) The fire detection system is to be so designed, and the detectors so positioned as to detect rapidly the onset of fire in any part of those spaces and under any normal conditions of operation of the machinery and variations of ventilation as required by the possible range of ambient temperatures. Except in spaces of restricted height, and where their use is especially appropriate, detection system using only thermal detectors is not to be permitted. The detection system is to initiate audible and visual alarms distinct in both respects from the alarms of any other system not indicating fire, in sufficient places to ensure that the alarms are heard and observed on the navigating bridge and by a responsible engineer officer. When the operating compartment is unmanned, the alarm is to sound in a place where a responsible member of the crew is on duty.
- (2) After installation, the system is to be tested under varying conditions of engine operation and ventilation.

4. Areas of major fire hazard are to be protected by an approved fixed fire-extinguishing system operable from the control position which is adequate for the fire hazard that may exist. The system is to comply with **201. 6** and be capable of local manual control and remote control from the continuously manned control stations. **[See Guidance]**

5. In all craft where gas is used as the extinguishing medium, the quantity of gas is to be sufficient

to provide two independent discharges. The second discharge into the space is only to be activated manually from a position outside the space being protected. Where the space has a local fire-suppression system installed to protect fuel oil, lubricating oil and hydraulic oil located near exhaust manifolds, turbo chargers or similar heated surfaces on main and auxiliary internal combustion engines, a second discharge need not be required. **[See Guidance]**

## 6. Requirements for fixed fire-extinguishing systems

### (1) General

- (A) The use of a fire-extinguishing medium which, either by itself or under expected conditions of use, will adversely affect the earth's ozone layer, and/or gives off toxic gases in such quantities as to endanger people, is not to be permitted.
- (B) The necessary pipes for conveying fire-extinguishing medium into protected spaces are to be provided with control valves so marked as to indicate clearly the spaces to which the pipes are led. Non-return valves are to be installed in discharge lines between cylinders and manifolds. Suitable provision is to be made to prevent inadvertent admission of the medium into any space.
- (C) The piping for the distribution of fire-extinguishing medium is to be arranged, and discharge nozzles so positioned, that a uniform distribution of medium is obtained.
- (D) Means are to be provided to close all openings which may admit air to, or allow gas to escape from, a protected space.
- (E) Where the volume of free air contained in air receivers in any space is such that, if released in such space in the event of fire, such release of air within that space would seriously affect the efficiency of the fixed fire-extinguishing system, the provision of an additional quantity of fire-extinguishing medium is to be required.
- (F) Means are to be provided for automatically giving audible warning of the release of fire-extinguishing medium into any space in which personnel normally work or to which they have access. The alarm is to operate for a suitable period before the medium is released, but not less than 20s. Visible alarm is to be arranged in addition to the audible alarm.
- (G) The means of control of any fixed gas fire-extinguishing system are to be readily accessible and simple to operate, and are to be grouped together in as few locations as possible at positions not likely to be cut off by a fire in a protected space. At each location there are to be clear instructions relating to the operation of the system having regard to the safety of personnel.
- (H) Automatic release of fire-extinguishing medium is not permitted. **[See Guidance]**
- (I) Where the quantity of extinguishing medium is required to protect more than one space, the quantity of medium available need not be more than the largest quantity required for any one space so protected.
- (J) Pressure containers required for the storage of fire-extinguishing medium are to be located outside protected spaces in accordance with (M) below. Pressure containers may be located inside the space to be protected if in the event of accidental release persons will not be endangered.
- (K) Means are to be provided for the crew to safely check the quantity of medium in the containers.
- (L) Containers for the storage of fire-extinguishing medium and associated pressure components are to be designed in accordance with **Pt 5, Ch 5 of Rules for the Classification of Steel Ships** with regard to their locations and maximum ambient temperatures expected in service.
- (M) When the fire-extinguishing medium is stored outside a protected space, it is to be stored in a room which is to be situated in a safe and readily accessible position and is to be effectively ventilated. Any entrance to such a storage room is preferably to be from the open deck, and in any case should be independent of the protected space. Access doors are to open outwards, and bulkheads and decks including doors and other means of closing any opening therein, which form the boundaries between such rooms and adjoining enclosed spaces, are to be gas tight. Such storage rooms are to be treated as control stations.
- (N) Spare parts for the system are to be stored on board or at a base port.
- (O) If the release of a fire extinguishing medium produces significant over or under pressurization in the protected space, means are to be provided to limit the induced pressures to acceptable limits to avoid structural damage.

### (2) Carbon dioxide systems

- (A) For cargo spaces, the quantity of carbon dioxide available is, unless otherwise provided, to

- be sufficient to give a minimum volume of free gas equal to 30 % of the gross volume of the largest cargo space so protected in the craft.
- (B) For machinery spaces, the quantity of carbon dioxide carried is to be sufficient to give a minimum volume of free gas equal to the larger of the volumes of (a) or (b) below.
- (a) 40 % of the gross volume of the largest machinery space so protected, the volume to exclude that part of the casing above the level at which the horizontal area of the casing is 40 % or less of the horizontal area of the space concerned taken midway between the tank top and the lowest part of the casing.
- (b) 35 % of the gross volume of the largest machinery space protected, including the casing.
- (c) For the purpose of this requirement, the volume of free carbon dioxide is to be calculated at  $0.56 \text{ m}^3/\text{kg}$ .
- (d) For machinery spaces, the fixed piping system is to be such that 85 % of the gas can be discharged into the space within 2 minutes.
- (e) Two separate controls are to be provided for releasing carbon dioxide into a protected space and to ensure the activation of the alarm. One control is to be used to discharge the gas from its storage containers. A second control is to be used for opening the valve of the piping which conveys the gas into the protected spaces.
- (f) The two controls are to be located into a release box clearly identified for the particular space. If the box containing the controls is to be locked, a key to the box is to be in a break-glass type enclosure conspicuously located adjacent to the box. The percentages in (a) and (b) above may be reduced to 35 % and 30 % respectively for cargo craft of less than 2,000 tons gross tonnage; provided also that if two or more machinery spaces are not entirely separate they are to be considered as forming one space.
7. Control stations, public spaces, crew accommodation, corridors and service spaces are to be provided with portable fire extinguishers of approved type and design. At least five portable extinguishers are to be provided, and so positioned, as to be readily available for immediate use. In addition, at least one extinguisher suitable for machinery space fires is to be positioned outside each machinery space entrance.
8. Fire pumps, and appropriate associated equipment, or alternative effective fire extinguishing systems are to be fitted as follows.
- (1) At least two independently driven pumps are to be arranged. Each pump is to have at least two thirds the capacity of a bilge pump as determined by Pt 5 but not less than  $25 \text{ m}^3/\text{h}$ . Each fire pump is to be able to deliver sufficient quantity and pressure of water to simultaneously operate the hydrants as required by (4) below. **【See Guidance】**
- (2) The arrangement of the pumps is to be such that in the event of a fire in any one compartment all the fire pumps will not be put out of action. **【See Guidance】**
- (3) Isolating valves to separate the section of the fire main within the machinery space containing the main fire pump or pumps from the rest of the fire main are to be fitted in an easily accessible and tenable position outside the machinery spaces. The fire main is to be so arranged that when the isolating valves are shut all the hydrants on the craft, except those in the machinery space referred to above, can be supplied with water by a fire pump not located in this machinery space through pipes which do not enter this space. The spindles of manually operated valves are to be easily accessible and all valves are to be clearly marked. **【See Guidance】**
- (4) Hydrants shall be so arranged so that any location on the craft can be reached by the water jets from two fire hoses from two different hydrants, one of the jets being from a single length of hose. Ro-ro spaces hydrants are to be located so that any location within the space can be reached by two water jets from two different hydrants, each jet being supplied from a single length of hose.
- (5) Each fire hose is to be of non-perishable material and have a maximum length approved by the Administration, Fire hoses, together with any necessary fittings and tools, are to be kept ready for use in conspicuous positions near the hydrants. All fire hoses in interior locations are to be connected to the hydrants at all times. One fire hose is to be provided for each hydrant as required by (4) above.
- (6) Each fire hose is to be provided with a nozzle of an approved dual purpose type (i.e. spray/jet type) incorporating a shutoff.
- (7) Where deep-fat cooking equipment is installed, all such installations are to be fitted with:
- (A) an automatic or manual fixed extinguishing system tested to an appropriate standard acceptable to the Society.

- (B) a primary and back up thermostat with an alarm to alert the operator in the event of failure of either thermostat.
- (C) arrangements for automatically shutting off the electrical power to the deep-fat cooking equipment upon activation of the extinguishing system.
- (D) an alarm for indicating operation of the extinguishing system in the galley where the equipment is installed.
- (E) controls for manual operation of the extinguishing system which are clearly labelled for ready use by the crew.

## 202. Protection of special category and ro-ro spaces

### 1. Fixed fire-extinguishing system

Each special category space and ro-ro spaces are to be fitted with an approved fixed pressure water-spraying system for manual operation which is to protect all parts of any deck and vehicle platform in such space, provided that the Society may permit the use of any other fixed fire-extinguishing system that has been shown by full-scale test in conditions simulating a flowing petrol fire in the space to be not less effective in controlling fires likely to occur in such a space.

### 2. Patrols and detection

- (1) A continuous fire patrol is to be maintained in special category spaces and ro-ro spaces unless a fixed fire detection and fire alarm system, complying with the requirements of **201. 2**, and a television surveillance system are provided. The fixed fire detection system is to be capable of rapidly detecting the onset of fire. The spacing and location of detectors are to be tested taking into account the effects of ventilation and other relevant factors. **[See Guidance]**
- (2) Manually operated call points are to be provided as necessary throughout the special category spaces and ro-ro spaces and one is to be placed close to each exit from such spaces. Manually operated call points are to be spaced so that no part of the space is to be more than 20 m from a manually operated call point.

### 3. Fire-extinguishing equipment

There is to be provided in each special category space and ro-ro space.

- (A) At least three water fog applicators,
- (B) One portable foam applicator unit consisting of an air-foam nozzle of an inductor type capable of being connected to the fire main by a fire hose, together with a portable tank containing 20 l of foam-making liquid and one spare tank. The nozzle is to be capable of producing effective foam suitable for extinguishing an oil fire of at least 1.5 m<sup>3</sup>/min. At least two portable foam applicator units are to be available in the craft for use in such space, and
- (C) Portable fire extinguishers of approved type and design are to be located so that no point in the space is more than approximately 15 m walking distance from an extinguisher, provided that at least one portable extinguisher is located at each access to such space.

### 4. Ventilation system

- (1) There is to be provided an effective power ventilation system for the special category spaces and ro-ro spaces sufficient to give at least 10 air changes per hour while navigating and 20 air changes per hour at the quayside during vehicle loading and unloading operations. The system for such spaces is to be entirely separated from other ventilation systems and is to be operating at all times when vehicles are in such spaces. Ventilation ducts serving special category spaces and ro-ro spaces capable of being effectively sealed are to be separated for each such space. The system is to be capable of being controlled from a position outside such spaces.
- (2) The ventilation is to be such as to prevent air stratification and the formation of air pockets.
- (3) Means are to be provided to indicate in the operating compartment any loss or reduction of the required ventilating capacity.
- (4) Arrangements are to be provided to permit a rapid shutdown and effective closure of the ventilation system in case of fire, taking into account the weather and sea conditions.
- (5) Ventilation ducts, including dampers, are to be made of steel or other equivalent material. Ducts lying inside the served space may be made of non-combustible or fire-restricting material.

### 5. Scuppers, bilge pumping and drainage

In view of the serious loss of stability which could arise due to large quantities of water accumulat-

ing on the deck or decks consequent to the operation of the fixed pressure water-spraying system, scuppers are to be fitted so as to ensure that such water is rapidly discharged directly overboard. Alternatively, pumping and drainage facilities are to be provided additional to the requirements of **Pt 5**. When it is required to maintain watertight or weathertight integrity, as appropriate, the scuppers are to be arranged so that they can be operated from outside the space protected.

#### 6. Precautions against ignition of flammable vapours

- (1) On any deck or platform, if fitted, on which vehicles are carried and on which explosive vapours might be expected to accumulate, except platforms with openings of sufficient size permitting penetration of petrol gases downwards, equipment which may constitute a source of ignition of flammable vapours and, in particular, electrical equipment and wiring, are to be installed at least 450 mm above the deck or platform. Electrical equipment installed at more than 450 mm above the deck or platform is to be of a type so enclosed and protected as to prevent the escape of sparks. However, if the installation of electrical equipment and wiring at less than 450 mm above the deck or platform is necessary for the safe operation of the craft, such electrical equipment and wiring may be installed provided that it is of a type approved for use in an explosive petrol and air mixture.
- (2) Electrical equipment and wiring, if installed in an exhaust ventilation duct, are to be of a type approved for use in explosive petrol and air mixtures and the outlet from any exhaust duct is to be sited in a safe position, having regard to other possible sources of ignition.

### 203. Fire control plans

1. There are to be permanently exhibited, for the guidance of the master and officers of the craft, fire control plans showing clearly for each deck the following positions.

The control stations, the sections of the craft which are enclosed by fire-resisting divisions together with particulars of the fire alarms, fire detection systems, the sprinkler installations, the fixed and portable fire-extinguishing appliances, the means of access to the various compartments and decks in the craft, the ventilating system including particulars of the master fan controls, the positions of dampers and identification numbers of the ventilating fans serving each section of the craft, the location of the international shore connection, if fitted, and the position of all means of control referred to in **Ch 1, 206. 3** and **207. 2.** and **Ch 2, 201. 1** and **4.**

The text of such plans is to be in the official language of the flag State. However, if the language is neither English nor French, a translation into one of those languages is to be included.

#### **[See Guidance]**

2. A duplicate set of fire control plans or a booklet containing such plans is to be permanently stored in a prominently marked weathertight enclosure outside the deckhouse for the assistance of shore side fire-fighting personnel.

### 204. Fire-fighter's outfits **[See Guidance]**

1. All craft, other than category A passenger craft, are to carry at least two fire-fighter's outfits complying with the requirements of **Par 3.** **[See Guidance]**
  - (1) In addition, there are to be provided in category B passenger craft for every 80 m, or part thereof, of the aggregate of the length of all passenger spaces and service spaces on the deck which carries such spaces; or, if there is more than one such deck, on the deck which has the largest aggregate of such length, two fire-fighter's outfits and two sets of personal equipment, each set comprising the items stipulated in **3. (1), (A) to (C)**;
  - (2) In category B passenger craft, for each pair of breathing apparatus there is to be provided one water fog applicator which is to be stored adjacent to such apparatus.
  - (3) Additional sets of personal equipment and breathing apparatus, having due regard to the size and type of the craft, may be required.
2. The fire-fighter's outfits, or sets of personal equipment, are to be so stored as to be easily accessible and ready for use and, where more than one fire-fighter's outfit or more than one set of personal equipment is carried, they are to be stored in widely separated positions.
3. A fire-fighter's outfit is to consist of:



- (1) Personal equipment comprising:
  - (A) Protective clothing of material to protect the skin from the heat radiating from the fire and from burns and scalding by steam or gases. The outer surface is to be water-resistant,
  - (B) Boots and gloves of rubber or other electrically non-conductive material,
  - (C) A rigid helmet providing effective protection against impact,
  - (D) An electric safety lamp (hand lantern) of an approved type with a minimum burning period of 3 hours, and
  - (E) An axe.
- (2) A breathing apparatus of an approved type which may be either:
  - (A) A smoke helmet or smoke mask which is to be provided with a suitable air pump and a length of air hose sufficient to reach from the open deck, well clear of hatch or doorway, to any part of the holds or machinery spaces. If, in order to comply with this subparagraph, an air hose exceeding 36 m in length would be necessary, a self-contained breathing apparatus is to be substituted or provided in addition, or
  - (B) A self-contained compressed-air-operated breathing apparatus, the volume of air contained in the cylinders of which is to be at least 1,200 l, or other self-contained breathing apparatus which is to be capable of functioning for at least 30 minutes. A number of spare charges, suitable for use with the apparatus provided, are to be available on board.
- (3) For each breathing apparatus, a fireproof lifeline of sufficient length and strength is to be provided capable of being attached by means of a snap hook to the harness of the apparatus or to a separate belt in order to prevent the breathing apparatus becoming detached when the lifeline is operated.

#### 205. Fuel and other flammable fluid tanks and systems

1. A fixed vapour detection system is to be installed in each space through which fuel lines pass, with alarms provided at the continuously manned control station.
2. Every fuel tank is, where necessary, to be provided with "savealls" or gutters which would catch any fuel which may leak from such tanks.
3. Safe and efficient means of ascertaining the amount of fuel contained in any tank are to be provided. Sounding pipes are not to terminate in any space where the risk of ignition of spillage from the sounding pipe might arise. In particular, they are not to terminate in passenger or crew spaces. The use of cylindrical gauge glasses is prohibited, except for cargo craft where the use of oil-level gauges with flat glasses and self-closing valves between the gauges and fuel tanks may be permitted. Other means of ascertaining the amount of fuel contained in any tank may be permitted if such means do not require penetration below the top of the tank, and providing their failure or overfilling of the tank will not permit the release of fuel.
4. During bunkering operations no passenger is to be on board the craft or in the vicinity of the bunkering station. Adequate 'No Smoking' and 'No Naked Lights' signs are to be posted. Vessel-to-shore fuel connections are to be of closed type and suitably grounded during bunkering operations.
5. The provision of fire detection and extinguishing systems in spaces where non-integral fuel tanks are located is to be in accordance with paragraphs **201. 1 to 4**.
6. Refuelling of the craft is to be done at the approved refuelling facilities, detailed in the route operational manual, at which the following fire appliances are provided:
  - (1) A suitable foam applicator system consisting of monitors and foam-making branch pipes capable of delivering foam solution at a rate of not less than 500 l/min for not less than 10 min.
  - (2) Dry powder extinguishers of total capacity not less than 50 kg.
  - (3) Carbon dioxide extinguishers of total capacity not less than 16 kg.

## Section 3 Additional Requirements for High Speed Passenger Craft

### 301. Fixed sprinkler system [See Guidance]

1. Public spaces and service spaces, crew accommodation areas where sleeping berths are provided, storage rooms other than those containing flammable liquids, and similar spaces are to be protected by a fixed sprinkler system. Manually operated sprinkler systems are to be divided into sections of appropriate size and the valves for each section, start of sprinkler pump(s) and alarms are to be capable of being operated from two spaces separated as widely as possible, one of which is to be a continuously manned control station. In category B craft, no section of the system is to serve more than one of the zones required in **Ch 1, 301**.
2. Plans of the system are to be displayed at each operating station. Suitable arrangements are to be made for the drainage of water discharged when the system is activated.
3. For the general guidance of fixed sprinkler systems, refer to **IMO Res. MSC. 44(65)**.
4. Category A craft need not comply with the requirements of **1** and **2** above providing that:
  - (1) Smoking is not permitted.
  - (2) Sales shops, galleys, service spaces, ro-ro spaces and cargo spaces are not fitted.
  - (3) The maximum number of passengers carried does not exceed 200.
  - (4) The voyage duration at operational speed from departure port to destination when fully laden does not exceed 2 hours.

## Section 4 Additional Requirements for High Speed Cargo Craft

### 401. Cargo spaces

Cargo spaces, except open deck areas or refrigerated holds, are to be provided with an approved automatic smoke detection system complying with **201. 2** to indicate at the control station the location of outbreak of a fire in all normal operating conditions of the installations and are to be protected by an approved fixed quick acting fire-extinguishing system complying with **201. 6 (1)** operable from the control station.

### 402. Fixed sprinkler system

1. Crew accommodation where sleeping berths are provided, having a total deck area greater than 50 m<sup>2</sup> (including corridors serving such accommodation), is to be protected by a fixed sprinkler system.
2. Plans of the system are to be displayed at each operating station. Suitable arrangements is to be made for the drainage of water discharged when the system is activated.

## Section 5 Additional Requirements for Craft and Cargo Spaces intended for the Carriage of Dangerous Goods

### 501. Application

For crafts intended for the carriage of dangerous goods and engaged on international voyage, the HSC Code is to be applied. ↓



2023

---

Guidance Relating to the  
Rules for the Classification of  
**High Speed and Light Crafts**

#### APPLICATION OF THE GUIDANCE RELATING TO THE RULES

This "Guidance Relating to the Rules for the Classification of High Speed and Light Crafts" (hereafter called as the Guidance Relating to the Rules) is prepared with the intent of giving details as to the treatment of the various provisions for items required the unified interpretations and items not specified in the Rules, and the requirements specified in the Guidance Relating to the Rules are to be applied, in principle, in addition to the various provisions in the Rules.

As to any technical modifications which can be regarded as equivalent to any requirements in the Guidance Relating to the Rules, their flexible application will be properly considered.

## APPLICATION OF "GUIDANCE RELATING TO THE RULES FOR THE CLASSIFICATION OF HIGH SPEED AND LIGHT CRAFTS"

1. Unless expressly specified otherwise, the requirements in the Guidance apply to Light Craft, or High Speed and Light Craft for which contracts for construction are signed on or after 1 July 2023.
2. The amendments to the rules for 2022 edition and their effective date are as follows:

**Effective Date 1 July 2023**

---

### Annex 3-1 Guidance for the Direct Strength Assessment

4. Direct strength calculation of catamaran(Newly added)

# CONTENTS

<b>PART 1 CLASSIFICATION AND SURVEYS .....</b>	<b>1</b>
<b>CHAPTER 1 CLASSIFICATION .....</b>	<b>1</b>
Section 1 General .....	1
<b>PART 3 HULL STRUCTURES .....</b>	<b>9</b>
<b>CHAPTER 1 DESIGN IN GENERAL .....</b>	<b>11</b>
Section 2 General .....	11
Section 4 Subdivision and Arrangement (2016) .....	11
Annex 3-1 Guidance for the Direct Strength Assessment .....	13
Annex 3-2 Guidance for Buckling Strength Calculation .....	22
<b>CHAPTER 2 DESIGN LOADS .....</b>	<b>37</b>
Section 4 Hull Girder Loads .....	37
<b>CHAPTER 4 STRUCTURE PRINCIPLES IN ALUMINIUM ALLOY .....</b>	<b>39</b>
Section 4 Hull Girder Strength .....	39
<b>CHAPTER 5 STRUCTURE PRINCIPLES IN FRP .....</b>	<b>41</b>
Section 1 General .....	41
<b>PART 4 HULL EQUIPMENT .....</b>	<b>43</b>
<b>CHAPTER 3 EQUIPMENT NUMBER AND EQUIPMENT .....</b>	<b>45</b>
Section 1 General .....	45
<b>PART 5 MACHINERY SYSTEM .....</b>	<b>47</b>
<b>CHAPTER 1 GENERAL .....</b>	<b>49</b>
Section 1 General .....	49
<b>CHAPTER 2 AUXILIARIES AND PIPING ARRANGEMENT .....</b>	<b>51</b>
Section 1 General .....	51
Section 2 Bilge Pumping System .....	51
Section 4 Ship-side Valves and Overboard Discharges .....	52
<b>CHAPTER 3 PRIME MOVERS, POWER TRANSMISSION SYSTEMS AND LIFT DEVICES, ETC. ....</b>	<b>53</b>
Section 1 General .....	53
<b>PART 6 ELECTRICAL EQUIPMENT AND CONTROL SYSTEMS .....</b>	<b>55</b>
<b>CHAPTER 1 ELECTRICAL EQUIPMENT .....</b>	<b>57</b>
Section 1 General .....	57

Section 2	Electric Equipment .....	57
<b>CHAPTER 2</b>	<b>CONTROL SYSTEMS .....</b>	<b>59</b>
Section 1	General .....	59
<b>PART 7</b>	<b>FIRE PROTECTION, DETECTION AND EXTINCTION .....</b>	<b>61</b>
<b>CHAPTER 1</b>	<b>FIRE PROTECTION .....</b>	<b>63</b>
Section 2	Structural Fire Protection .....	63
Section 3	Additional Requirements for High Speed Passenger Craft .....	64
<b>CHAPTER 2</b>	<b>FIRE DETECTION AND EXTINCTION .....</b>	<b>65</b>
Section 2	Fire Detection and Extinction .....	65
Section 3	Additional Requirements for High Speed Passenger Craft .....	66
Section 4	Additional Requirements for High Speed Cargo Craft .....	66

**PART 1**  
**CLASSIFICATION AND SURVEYS**



## CHAPTER 1 CLASSIFICATION

### Section 1 General

#### 101. Application

1. In application to **101. 5** of the Rules, the terms "determined at the discretion of this Society" mean to comply with the requirements specified in the following **2.** through **7.**

#### 2. Application

(1) This requirement is applied to the ships which are subject to Korean Ship Safety Act and Notification having a restricted to domestic service.

(2) For the items not mentioned in this requirements, they are to be comply with related requirements on Korean Ship Safety Act.

#### 3. Definition

(1) "Vehicle area" means the vehicle loading area indicated in vehicle arrangement.

(2) "Vehicle deck" means the deck providing passageway of vehicles or vehicle loading deck providing in vehicle area.

(3) "Open space" means the followings:

(A) The bulkhead is not provided at the end of fore and after, and openings are not provided on the shell plating of vehicle area. In this case, the area of openings on the upper deck of considering area is to be comply with the followings.

$$\frac{a}{A} \geq \frac{1}{2}$$

$a$  = area of opening on the upper deck

$A$  = area of vehicle deck

(B) When the openings are provided on the both side shell plating in vehicle area, the area of opening is comply with the following.

$$\frac{a}{A} + \frac{5}{3} \frac{S_a}{S_A} \geq \frac{1}{2}$$

$a, A$  = as specified in (A)

$S_a$  = area of opening on one side in vehicle area.

$S_A$  = area of shell plating on one side in vehicle area.

(4) "Closed space" means closed space with weathertight other than above mentioned (3)

(5) The weight of mediums stored on board for the fixed fire-fighting systems(e.g. freshwater, CO2, dry chemical powder, foam concentrate, etc.) shall be included in the lightweight and lightship condition given in the **103. (9)** of the **Rules.(2018)**

#### 4. Submission of plans and documentations

For the securing device of vehicle and cargo, the following plans and documentations are to be submitted.

(A) Data which is able to be conformed the foreordinated route of ship, (for examples; conviction certificate of Owner or provisional Approvals for operation issued by the Authority).

(B) Vehicle and cargo loading plan

#### 5. Vehicle area

(1) Either one of the following equipment is to be provided to the ships having a closed space.

(A) CCTV which is capable of monitoring the whole vehicle area on the navigation bridge

(B) Light indicator and audible alarm which is capable of confirming the state of opening/closing of vehicle area entrance door on the navigation bridge

- (2) Indication in vehicle area
  - (A) In the vehicle area, the passageway for the using of access door, stairway, life saving appliances or fire extinguishing appliances is to be provided. This passageway is to be discriminated boundary line with easily visible color.
  - (B) For the ferries, when the lamp or inside door is not provided in location of fore peak bulkhead the warning mark "Vehicles may not be loaded forward the fore peak bulkhead" is to be provided.
  - (C) Vehicle area is to be marked clearly and vehicle load plan including following items is to be posted in the location where they are easily recognized.
    - (a) Maximum load of ship
    - (b) Maximum number of vehicles
    - (c) Notice items in loading vehicle
  - (D) "Notice items in loading vehicle" in (C) (c) is as follows and is to be included in vehicle and cargo load plan.
    - (a) Axle loads are not to exceed 00 ton(axle load is reviewed based on the maximum load 00 ton truck.
    - (b) The total weight of vehicles(including loaded on the vehicle) which is loaded on ship are not to exceed 00 ton(the total weight of vehicles is reviewed based on the number(00 vehicles) of maximum load 00 ton truck.)
    - (c) When the loaded vehicles are increased according to the loading of similar vehicles, proper type and number of movable securing devices which has sufficient strength is to be provided additionally.
    - (d) When similar vehicles are loaded, the loading and arrangement of the vehicles are to be properly to ensure the stability.

## 6. Vehicle load method and securing device

- (1) Vehicle load method
  - (A) Vehicles are to be loaded toward the direction of bow and stern. However, when the sufficient additional treatments for transverse sliding such as wedges etc. are provided, it may not be needed.
  - (B) Vehicles are not to be loaded forward the fore peak bulkhead.
  - (C) The space between loaded vehicles is not to be less than 600 mm.
  - (D) In the vehicle area, boundary line with easily visible color or the protection is to be provided for the access prohibition within 1 m near the access door, stairway and fire extinguishing arrangements.
  - (E) Vehicles are to be arranged to allow sufficient space for the passageway leading to assembly stations and embarkation stations etc. in an emergency.
- (2) Vehicle securing method
  - (A) Vehicles are to be secured to the ship by fixed securing devices(e.g.: D-ring, Clover socket and Deck eye plate etc.) and movable securing devices(e.g.: Web lashing, Turn buckle and Chain etc.) which are comply with the requirements in (4).
  - (B) Securing devices(fixed and movable securing devices) fixing vehicles and general cargos are to be approved by the Society. However, when securing devices are manufactured by approved manufacturer which is approved by the Society according to international standard such as ISO etc., the approval may be replaced by the manufacturer's certificate.
  - (C) Sufficient number of fixed securing devices are to be provided to consider the loading of vehicles which are not marked in vehicle and cargo loading plan.
  - (D) movable securing devices for the ships(1,000 tons gross tonnage and above) engaged in coastal service and it's over are to be provided to more than 1.2 times of approved amount.
  - (E) The securing of vehicle is to be loaded in accordance with vehicle and cargo loading plan. Before and during the voyage, it is to be checked by crews.
  - (F) The securing of vehicle is to be secured by more than 4 wheels or 2 parts of front and rear of vehicle using provided securing devices in vehicle and more than 4 fixed securing devices.
  - (G) For the ships which is only engaged in smooth water and having not more than 30 min. of navigating time, the ships which has less than 1 hour of navigating time in smooth water and coastal area service and loaded with cars, less than 12-seater's passenger vans and 1.5 ton truck (For the ship having a port of call in middle of operation, a port of call as regarded as departure port and arrival port), if they have a sufficient treatments for non-slip as keys etc. with smooth sea condition(wave height is to be less than 1.5 m and wind

speed is to be less than 7 m/sec), vehicles may not be secured.

- (3) Vehicle cargo loading
- (A) The capacity of cargo being loaded on the vehicle is to comply with following requirements.
- The length of loaded cargo is to be less than the length of vehicle plus one tenth of the length of vehicle
  - The width of loaded cargo is to be less than the range which can be checked by rear view mirror.
  - The height of loaded cargo is to be less than 4 m from the ground. Where the truck such as a van etc. having cargo space with roof cover, the height is from the ground to the top of the cover.
- (B) Cargo being loaded on the vehicle is to be secured to ensure the load by the movements of ship which is described in the (4).
- (4) Strength of securing device
- (A) The definitions of terms that are used to assess the strength of the securing devices are as follows.
- $W$  = total weight of vehicle(load + vehicle weight) (ton)
- $x, y, z$  = longitudinal, transverse and vertical distance from the center of rolling and pitching to the center of under consideration vehicle, respectively
- $\phi, \psi$  = rolling and pitching angle of ship as specified in **Table 1** respectively (deg) (see **Fig. 1**)
- $T_r, T_p$  = rolling and pitching cycle of ship as specified in **Table 1** respectively (sec)
- $V$  = vertical force to deck during rolling and pitching of ship (ton) (see **Fig. 1**)
- $H_r$  = force acting to transverse direction which is parallel to deck during rolling of ship (ton) (see **Fig. 1**)
- $H_p$  = force acting to longitudinal direction which is parallel to deck during pitching of ship (ton) (see **Fig. 1**)
- $M_r$  = overturning moments during rolling of ship (ton-m) (see **Fig. 2**)
- $SF_r, SF_p$  = forces acting on vehicle which is parallel to longitudinal and transverse deck respectively (ton)
- $b_m$  = full width of vehicle (m) (see **Fig. 2**)
- $b_t$  = spacing of wheels (m) (see **Fig. 2**)
- $h_m$  = height from deck to the center of gravity of the vehicle (m) (see **Fig. 2**)
- $L_r, L_p$  = sum of the transverse and longitudinal horizontal component which movable securing devices can withstand (ton)
- $M_l$  = sum of the force to resist for vehicle overturning moment by movable securing devices (ton)
- $n$  = number of movable securing devices used for one vehicle
- $\alpha, \beta$  = transverse and longitudinal angle between movable securing devices and deck respectively (deg) (see **Fig. 2**)
- $h$  = height from deck to the point of vehicle securing (m) (see **Fig. 2**)
- $T$  = safety working load of movable securing devices which is divided breaking load with safety factor of **Table 1** (ton)
- $\mu$  = friction coefficients between vehicle and deck, as shown below
- tire(rubber) / non-slipped paint: 0.7
  - tire(rubber) / steel deck: 0.3
  - steel / steel deck: 0.1(when dry)
  - steel / steel deck: 0.0(when wet)
  - timber / steel deck: 0.3
- (B) The loads acting on the securing device is to be determined in consideration of the movements of ship which is described in the **Table 1**.

Table 1 Ship motion

Rolling		Pitching		Safety factor
degree	cycle 3)	degree	cycle	
10°	cycle of ship	5°	5 sec	4 over

(Note)

- $KG'$  is the value obtained from the following formula.  

$$KG' = 0.5(KG + KB)$$

$KG$  = the vertical position of the centric of the ship  
 $KB$  = the vertical position of the buoyancy centric of the ship
- The centric of pitching is to be longitudinal position of the centric of the ship.
- The rolling cycle of the ship may be taken from  $T_R$  of **Pt 3, Ch 2, 203. 2.** of the Rule.

(C) Each component of the loads caused by motions of the ship is shown in **Fig. 1** and **Table 2**.

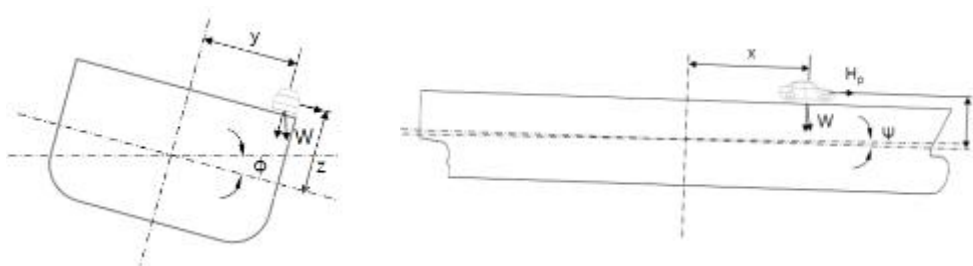

Fig. 1 Motions of the ship

Table 2 Load components

Type		Load components (ton)		
		Vertical force	Horizontal force	
			transverse	longitudinal
Static load	Rolling	$W \cos \phi$	$W \sin \phi$	–
	Pitching	$W \cos \psi$	–	$W \sin \psi$
	Combination	$W \cos (0.71 \phi) \cos (0.71 \psi)$	$W \sin (0.71 \phi)$	$W \sin (0.71 \psi)$
Dynamic load	Rolling	$0.07024 W \frac{\phi}{T_r^2} y$	$0.070247 W \frac{\phi}{T_r^2} z$	–
	Pitching	$0.07024 W \frac{\psi}{T_p^2} x$	–	$0.07024 W \frac{\psi}{T_p^2} z$

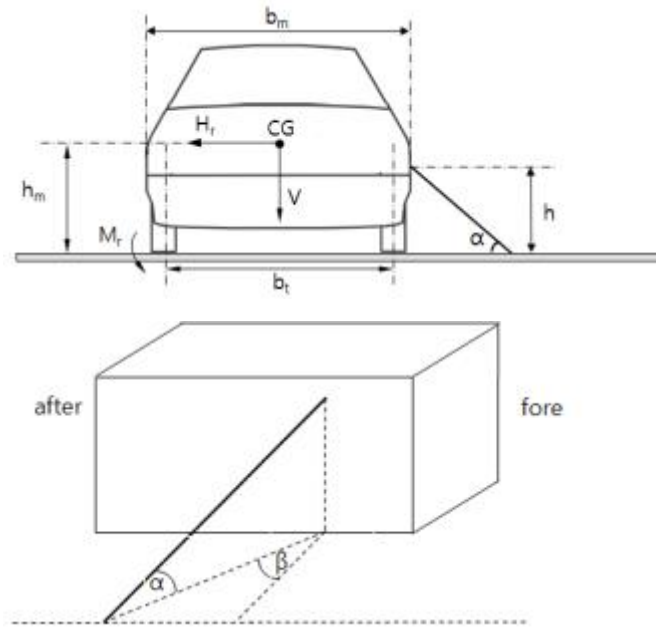

Fig. 2 Various dimensions during vehicle securing

- (D) The forces caused by motions of the ship are as follows.  
(a) Vertical force: the smallest among  $V_1$ ,  $V_2$  and  $V_3$

$$V_1 = W \left[ \cos(0.71\phi) \cos(0.71\psi) - 0.07024 \frac{\phi}{T_r^2} y - 0.07024 \frac{\psi}{T_p^2} x \right]$$

$$V_2 = W \left[ \cos\phi - 0.07024 \frac{\phi}{T_r^2} y \right]$$

$$V_3 = W \left[ \cos\psi - 0.07024 \frac{\psi}{T_p^2} x \right]$$

- (b) Transverse horizontal force:

$$H_r = W \left[ \sin\phi + \frac{0.07024\phi}{T_r^2} z \right]$$

- (c) Longitudinal horizontal force:

$$H_p = W \left[ \sin\psi + \frac{0.07024\psi}{T_p^2} z \right]$$

- (E) The loads to be considered as acting on the vehicle are to be determined according to following formula.

- (a) Transverse horizontal force

$$SF_r = H_r - \mu V$$

- (b) Longitudinal horizontal force

$$SF_p = H_p - \mu V$$

- (c) Rolling overturning moments

$$M_r = H_r \times h_m - 0.5 V \times b_m$$

- (F) The forces caused by motions of the ship are as follows.

- (a) Transverse horizontal component:

$$L_r = \sum_{i=1}^{n/2} T_i \cdot (\cos\alpha_i \cdot \cos\beta_i + \mu\sin\alpha_i)$$

- (b) Longitudinal horizontal component:

$$L_p = \sum_{i=1}^{n/2} T_i \cdot (\cos\alpha_i \cdot \sin\beta_i + \mu\sin\alpha_i)$$

- (c) overturning moments horizontal component:

$$M_l = \sum_{i=1}^{n/2} T_i \cdot (0.5(b_m + b_l)\sin\alpha_i + h \cdot \cos\alpha_i\cos\beta_i)$$

- (G) Movable securing devices are to be complied with following formula.

(a) Transverse horizontal component :  $SF_r \leq L_r$

(b) Longitudinal horizontal component :  $SF_p \leq L_p$

(c) overturning moments horizontal component :  $M_r \leq M_l$

- (5) Drawing guidance for vehicle and cargo loading plan

(A) The arrangement and loading method of vehicles intended to load among the vehicles as specified in "Enforcement Regulations of the Automobile Management Act Appendix Table 1" is to be indicated in the loading plan. In this case, where the total weight of the vehicle is within the range of the total weight of the approved vehicle and fixation method and securing strength is suitable, other vehicles, construction machinery as specified in "Presidential Decree for the Construction Machinery Management Act Appendix Table 1" and agricultural machinery as specified in "Enforcement Regulations of the Agricultural Mechanization Promotion Act Appendix Table 1" etc. are to be loaded in accordance with the loading plan.

(B) Notwithstanding the (A) above, where the vehicle type intended to load is decided by the owner of ship especially, the vehicle loading plan reflected the arrangement and loading method of the vehicle is to be approved.

(C) Where intended to load the vehicle other than (A) above, the vehicle loading plan reflected the arrangement and loading method of the vehicle is to be approved additionally.

(D) Vehicle and cargo loading plan is to be included following items.

(a) arrangement and detail of fixed securing devices(types, material, breaking strength etc.)

(b) detail of movable securing devices(material, breaking strength, instructions etc.)

(c) arrangement and securing details for the vehicles intended to load(position of securing point of vehicle and ship, type of movable securing devices)

(d) specification of the vehicles intended to load(length and width of vehicle, vehicle weight including cargo weight)

(e) fire-extinguishing appliances, drainage facilities and passageway

(f) notice in **Par 6** (8) (D)

(g) when cargoes other than vehicles are loaded, the description of loading and securing method

(E) The plan is to be not less than a 1:200 scale.

- (6) Cargo loading other than vehicles

(A) In the vehicle area, unless it is approved by the Society, no cargoes other than vehicles may be loaded. For the cargoes loading other than vehicles, the documents for the closure and loading arrangements by the kinds of cargoes are to be submitted and approved by this Society.

(B) For freight container in one tier, the container is to be secured at their lower 4 corners by fixed securing devices(socket, D-ring, sliding base, lashing plate etc.) which is secured to the ship. For freight container in more than two tiers, the container is to be secured at their lower 4 corners to the upper 4 corners of below container by movable securing devices(twist lock, stacker etc.) or the container is to be secured directly to ship by lashing

rod or turnbuckle. These fixed and movable securing devices are to comply with the requirement in **Guidance Pt 7**, Annex 7-2.

- (C) General cargoes(excluding passenger's personal belongings) except cargoes approved in vehicle and cargo loading plan it's arrangement • loading • securing method is to be loaded in storage facilities to made available for securing and is to be secured to comply with the requirement in (4).

#### 7. Electric equipment

- (1) Installation and utilization of electricity supply cables to loaded vehicle
  - (A) A ship with enclosed vehicle loading space which carries live-fish transporting trucks must be installed with reel lead electricity supply cables which satisfies the below requirements, readily available to supply electricity for every each vehicle it carries.
    - (a) Must have a circuit breaker for overload
    - (b) Cables must be fire resistant
  - (B) A live-fish transporting truck on board the ship must have it's engine turned off during the voyage and acquire the electricity necessary for oxygen supplier from the ship. ↓

**PART 3**  
**HULL STRUCTURES**



---

## CHAPTER 1 DESIGN IN GENERAL

### Section 2 General

#### 203. Direct strength calculations

1. Where scantlings of structural members are determined based on the direct strength calculation, ANNEX 3-1 「**Guidance for the Direct Strength Assessment**」 shall be followed. If the application of the Guidance is considered inappropriate, analysis method, loads and allowable stress as deemed appropriate by the Society may be applied.
2. Based on the results according to the direct strength calculation, the buckling strength of the structural members are to be examined by using the method and allowable stress given in ANNEX 3-2 「**Guidance for the Buckling Strength Calculation**」.

### Section 4 Subdivision and Arrangement (2016)

#### 410. Doors, windows, etc., in boundaries of weathertight spaces

1. (1) In application to **410. 1.** of the Rules, the doors on the superstructure forward end wall of the ships are not to be made by FRP. This requirement is to apply to ships with HSLC notation engaged on domestic voyage only.  
(2) Windows fitted on weather-tight doors are to remain securely fixed. ↓

## Annex 3-1 Guidance for the Direct Strength Assessment

### 1. Direct strength calculation of steel ships

#### (1) General

##### (A) Application

The application of direct stress analysis is governed by:

- (a) In such cases where simplified formulations are not able to take into account special stress distributions, boundary conditions or structural arrangements with sufficient accuracy, direct stress analysis may be required.
- (b) In some cases direct stress calculations may give reduced scantlings, especially when optimization routines are incorporated.

#### (2) Plating

Normally direct strength analysis of laterally loaded plating is not required as part of rule scantling estimation.

#### (3) Stiffeners

##### (A) General

Direct strength analysis of stiffeners may be requested in the following cases:

- (a) stiffeners affected by supports with different deflection characteristics
- (b) stiffeners subject to large bending moments transferred from adjacent structures at supports

##### (B) Calculation procedure

- (a) The calculations are to reflect the structural response of the 2 or 3 dimensional structure considered. Calculations based on elastic beam element models or finite element analyses may normally be applied, with due attention to:
  - boundary conditions
  - shear area and moment of inertia variations
  - effective flange
  - effects of bending, shear and axial deformation
  - influence of end brackets
- (b) Plastic deformation is to be taken into account for the end parts of stiffeners attached on the watertight bulkheads.

##### (C) Loads

- (a) The local lateral loads are to be taken as specified in **Pt 3, Ch 3, Sec. 4 to Sec 8.**
- (b) For double bottom and other cofferdam type structures, a cofferdam bending moment and a shear force inducing stiffener bending moment may have to be considered at the same time.

##### (D) Allowable stresses

- (a) Allowable stress level for stiffeners is given in **Table 3.1.**
- (b) Stiffeners are in no case to have web and flange thickness less than given in **Pt 3, Ch 3, 601.**

**Table 3.1 Allowable Stresses for Stiffeners**

Nominal local bending stress	General	$\sigma = 180 / K \text{ (N/mm}^2\text{)}$
	Watertight bulkheads except collision bulkhead	$\sigma = 245 / K \text{ (N/mm}^2\text{)}$
Combined local bending stress/girder stress / extreme longitudinal stress		$\sigma = 230 \sim 265 / K^{(*)} \text{ (N/mm}^2\text{)}$
Nominal shear stress	General	$\tau = 90 / K \text{ (N/mm}^2\text{)}$
	Watertight bulkheads except collision bulkhead	$\tau = 120 / K \text{ (N/mm}^2\text{)}$
(*) : In case of girder stress, longitudinal stress is as specified in <b>Pt 3, Ch 3, 403.</b>		

(4) Girders

(A) General

- (a) For girders in 2- or 3-dimensional structural system, a complete structural analysis may have to be carried out to demonstrate that the stresses are acceptable when the structure is loaded as described in (C).
- (b) Calculations may have to be carried out for:
- bottom structures
  - side structures
  - deck structures
  - bulkhead structures
  - transverse frame structures in monohull craft supporting deckhouses, containers and other permanent or cargo masses subject to tripping
  - strength of deck along wide hatches
  - other structures when deemed necessary by the Society

(B) Calculation methods

- (a) Calculation methods or computer programs applied are to take account the effects of bending, shear, axial and torsional deformations. The calculations are to reflect the structural response of the 2- or 3-dimensional structure considered, with due attention to boundary conditions. For systems consisting of slender girders, calculations based on beam theory (frame work analysis) may be applied, with due attention to:
- shear area variation
  - moment of inertia variation
  - effective flange
- (b) For rise of floor bottoms, shear in the bottom plating will resist vertical deflection of the keel, with a releasing effect on the longitudinal girder, which may be taken into account.
- (c) For deep girders, bulkhead panels, bracket zones, etc. where results obtained by applying the beam theory are unreliable, finite element analysis or equivalent methods are to be applied.

(C) Design load conditions

- (a) The calculations are to be based on the loads at design level as given in **Pt 3, Ch 2**.
- (b) For sea-going conditions realistic combinations of external and internal dynamic loads and inertia forces are to be considered.
- (c) The mass of deck structures may be neglected when less than 5% of the applied loads are in the vertical direction.

(D) Allowable stresses

- (a) The equivalent stress is defined as:

$$\sigma_e = \sqrt{\sigma_x^2 + \sigma_y^2 - \sigma_x \sigma_y + 3\tau^2}$$

$\sigma_x$  : normal stress in x-direction

$\sigma_y$  : normal stress in y-direction

$\tau$  : Shear stress in the xy-plane

- (b) For girders in general, the following stresses given in **Table 3.2** are normally acceptable.
- (c) For girders subjected to hull girder stresses, the following additional requirement applies.

$$\sigma_e = 90/K \quad (\text{N/mm}^2)$$

plus maximum allowable longitudinal stress according to **Pt 3, Ch 3, Sec 403**.

or maximum allowable transverse stress according to **Pt 3, Ch 3, Sec 406**.

- (d) The actual longitudinal or transverse stress in the girder is taken from the calculation in **Pt 3, Ch 3**.

(E) Allowable deflections

- (a) Requirements for minimum moment of inertia or maximum deflection are to be considered for hatchways, doors or special cases.
- (b) Designers are to pay due attention to deflections in general.
- (c) For weather deck hatch coamings, the horizontal deflection at weather tightening level

should not exceed 25 mm, unless tightness at a greater deflection may be proved. For weathertight and watertight hatches and doors, the relative deflection of cover and hull coamings in the pressure direction should not result in leakage due to loss of packing pressure.

- (d) Deflection limits of girders and coamings of covers and doors themselves are found in **Pt 3, Ch 4** in terms of a moment of inertia requirement.

**Table 3.2 Allowable Stresses for Girders**

	Girders in general	For girders on watertight bulkheads except for the collision bulkhead	For transverse structures and partial longitudinal structures supporting deck-houses, containers etc. in the rolling and pitching conditions
Normal stress( $\sigma$ )	$160/K$ (N/mm <sup>2</sup> )	$220/K$ (N/mm <sup>2</sup> )	$210/K$ (N/mm <sup>2</sup> )
Mean shear stress( $\tau$ )	$90/K$ (N/mm <sup>2</sup> ) with one plate flange	$120/K$ (N/mm <sup>2</sup> ) with one plate flange	$115/K$ (N/mm <sup>2</sup> ) with one plate flange
	$100/K$ (N/mm <sup>2</sup> ) with two plate flanges	$130/K$ (N/mm <sup>2</sup> ) with two plate flanges	$125/K$ (N/mm <sup>2</sup> ) with two plate flanges
Equivalent stress( $\sigma_e$ )	$180/K$ (N/mm <sup>2</sup> )	$240/K$ (N/mm <sup>2</sup> )	$230/K$ (N/mm <sup>2</sup> )

## 2. Direct strength calculation of aluminium alloy ships

### (1) General

#### (A) Application

The application of direct strength analysis is governed by:

- (a) In such cases where simplified formulations are not able to take into account special stress distributions, boundary conditions or structural arrangements with sufficient accuracy, direct strength analysis may be required.
- (b) In some cases direct strength calculations may give reduced scantlings, especially when optimization routines are incorporated.

### (2) Plating

(A) Normally direct strength analysis of laterally loaded plating is not required as part of rule scantling estimation.

(B) Laterally loaded local plate fields may be subject to direct stress analysis applying general 3-dimensional plate theory or finite element calculations. The calculations should take account the boundary conditions of the plate field as well as membrane stresses developed during deflection of the plate.

#### (C) Allowable stresses

- (a) When combining the calculated local bending stress with in-plane stresses the equivalent stress  $\sigma_e$  in the middle of a local plate field is not to exceed  $240/K$  (N/mm<sup>2</sup>). The local bending stress in the same point is in no case to exceed  $160/K$  (N/mm<sup>2</sup>).

$$\sigma_e = \sqrt{\sigma_x^2 + \sigma_y^2 - \sigma_x \sigma_y + 3\tau^2}$$

$\sigma_x$  : sum of local bending stress and in-plane stresses in the  $x$ -direction

$\sigma_y$  : sum of local bending stress and in-plane stresses in the  $y$ -direction

$\tau$  : shear stress in the  $xy$ -plane

- (b) The final thickness is not, however, to be less than the minimum thickness for the structure in question.

- (3) Stiffeners
- (A) General  
Direct strength analysis of stiffeners may be requested in the following cases:
- (a) stiffeners affected by supports with different deflection characteristics
  - (b) stiffeners subject to large bending moments transferred from adjacent structures at supports
- (B) Calculation procedure
- (a) The calculations are to reflect the structural response of the 2 or 3 dimensional structure considered. Calculations based on elastic beam element models or finite element analyses may normally be applied, with due attention to:
    - boundary conditions
    - shear area and moment of inertia variations
    - effective flange
    - effects of bending, shear and axial deformation
    - influence of end brackets
  - (b) Plastic deformation is to be taken into account for the end parts of stiffeners attached on the watertight bulkheads.
- (C) Loads  
The local lateral loads are to be taken as specified in **Pt 3, Ch 2**.
- (D) Allowable stresses  
Allowable stress level for stiffeners is given in **Table 3.3**.

**Table 3.3 Allowable Stresses for Stiffeners**

Nominal local bending stress	$\sigma = 160 / K(\text{N/mm}^2)$
Combined local bending stress or girder stress or longitudinal stress	$\sigma = 220 / K(\text{N/mm}^2)$
Nominal shear stress	$\tau = 90 / K(\text{N/mm}^2)$

- (4) Girders
- (A) General
- (a) For girders in 2- or 3-dimensional structural system, a complete structural analysis may have to be carried out to demonstrate that the stresses are acceptable when the structure is loaded as described in (C).
  - (b) Calculations may have to be carried out for:
    - bottom structures
    - side structures
    - deck structures
    - bulkhead structures
    - transverse frame structures
    - other structures when deemed necessary by the Society
- (B) Calculation methods
- (a) Calculation methods or computer programs applied are to take account the effects of bending, shear, axial and torsional deformations. The calculations are to reflect the structural response of the 2- or 3-dimensional structure considered, with due attention to boundary conditions. For systems consisting of slender girders, calculations based on beam theory (frame work analysis) may be applied, with due attention to:
    - shear area variation
    - moment of inertia variation
    - effective flange
  - (b) For deep girders, bulkhead panels, bracket zones, etc. where results obtained by applying the beam theory are unreliable, finite element analysis or equivalent methods are to be applied.
- (C) Design load conditions
- (a) The calculations are to be based on the loads at design level as given in **Pt 3, Ch 2**. For sea-going conditions realistic combinations of external and internal dynamic loads and inertia forces are to be considered. The mass of deck structures may be neglected when less than 5% of the applied loads are in the vertical direction.

- (b) For transverse web frame analysis, the following combinations of load apply.
- sea pressure on all elements
  - slamming pressure on bottom
- (c) If twin hull, the following three conditions are to be added:
- slamming pressure on bottom from outside and sea pressure on hull outer side
  - slamming pressure on bottom from inside and sea pressure on tunnel side tunnel top
  - slamming pressure on tunnel top and sea pressure on tunnel side and bottom from inside
- For all load cases, deck load pressure from cargo, passengers etc. is to be added.
- (D) Allowable stresses
- (a) The equivalent stress is defined as:

$$\sigma_e = \sqrt{\sigma_x^2 + \sigma_y^2 - \sigma_x \sigma_y + 3\tau^2}$$

$\sigma_x$  : normal stress in x-direction

$\sigma_y$  : normal stress in y-direction

$\tau$  : Shear stress in the xy-plane

- (b) The longitudinal combined stress taken as the sum of hull girder and longitudinal bottom, side or deck girder bending stresses, is normally not to exceed  $190/K$  (N/mm<sup>2</sup>).
- (c) For girders in general, the following stresses given in **Table 3.4** are normally acceptable.

**Table 3.4 Allowable Stresses for Girders**

Normal stress( $\sigma$ )	$160/K$ (N/mm <sup>2</sup> )
Mean shear stress( $\tau$ )	$90/K$ (N/mm <sup>2</sup> ) with one plate flange $100/K$ (N/mm <sup>2</sup> ) with two plate flanges
Equivalent stress( $\sigma_e$ )	$180/K$ (N/mm <sup>2</sup> )

### 3. Direct strength calculation of FRP ships

(1) General

- (A) Direct calculation using the full stiffness and strength properties of the laminates in all directions will be accepted based on the criteria given below.
- (a) Laminates are dimensioned in accordance with the Tsai-Wu composite strength criterion.
- (b) The failure strength ratio,  $R$ , for a ply in the Tsai-Wu failure criterion is expressed as:

$$(F_{ij} \sigma_i \sigma_j) R^2 + (F_i \sigma_i) R - 1 = 0, \quad i, j = 1, 2, 3, 4, 5, 6$$

Where  $R \leq 1$  indicates ply failure.

The terms in the failure criterion are defined in the notes in **Table 3.5**

- (c) All relevant load combinations for the laminate panel are to be considered.
- (2) Allowable stress and deflections
- (A) For direct calculations in accordance with (1) (A) (b), the failure strength ratio,  $R$ , is not to be less than the values given in **Table 3.5**. Core shear stresses in sandwich panels shall be in accordance with **Pt 3, Ch 5, Sec 5**. Panel deflections shall not be greater than specified in **Pt 3, Ch 5, Sec. 5** and **Sec 6**.

### 4. Direct strength calculation of catamaran (2023)

(1) General

- (A) This regulation applies to catamarans.
- (B) When determining the scantling of structural members of catamarans by direct strength calculation, the data necessary for direct strength calculation are to be submitted and ap-

- proved in advance by the Society.
- (C) The allowable stress criteria and buckling strength evaluation criteria according to the materials are in accordance with 1. to 3. of this annex and **Annex 3-2**.
- (2) Direct strength calculation of full ship structure
- (A) Structural modeling
- The direct strength calculation is to be applied for the hull structure that contributes to the hull girder strength.
  - In case of modeling with plate or shell element, in principle, the finite element division is divided into two or more elements between adjacent web frames in the longitudinal direction and by the spacing of longitudinals in the width direction. An example of the full ship structure model is shown in **Figure 3.1.1**.
  - In case aluminum extruded members are used as structural members, the orthotropic elements or composed model with plate and stiffener elements should be used for the members.

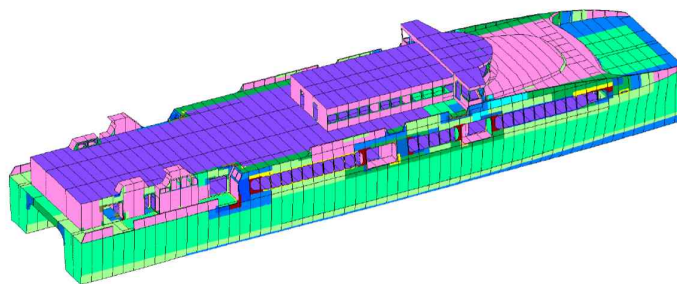

Figure 3.1.1 An example of the full ship structural model

- (B) Boundary conditions
- For the boundary condition given to the full ship analysis model, a simple support can be applied to reflect the actual structural behavior, or an inertia relief condition can be applied with the center of gravity of the hull as the reference point in consideration of the geometric characteristics of the catamaran.
- (C) Load conditions
- Full ship analysis is to be performed for the load cases derived from ship motion analysis acceptable to the Society. If the hull girder loads in **Pt 3, Ch 2, Sec 4 of the Rules** is applied instead of the loads from ship motion analysis, the strength evaluation can be performed for the load cases shown in **Table 3-6**.
  - In accordance with **Pt 3, Ch 2, Sec 3 304. ~ 307. of the Rules**, the hull weight, cargo/passenger load and sea water pressure are to be applied in the structural model in advance applying the hull girder load.
  - For vertical bending moment, the larger moment is to be used compared with the bending moment ( $M_B$ ) due to impact load in **Pt 3, Ch 2, Sec 4, 401. 2 of the Rules** and the hogging/sagging moment ( $M_{hog}$ ,  $M_{sag}$ ) in **401. 4**. In order to apply the vertical bending moment defined in the above regulation to the full ship model, the weight and buoyancy can be distributed in way of longitudinal direction of the hull as shown in the example in **Figure 3.1.2**. In the case of weight, the distributed loads can be applied to the deck by frame spacing, and in the case of buoyancy, the concentrated loads can be applied to the keel position by frame spacing as shown in **Figure 3.1.3**.
  - For the transverse bending moment ( $M_S$ ), the horizontal split force ( $F_y$ ) of **Pt 3, Ch 2, Sec 4, 402. 2. (2) of the Rules** can be applied as shown in **Figure 3.1.4**.
  - The longitudinal/transverse torsional moment of **Pt 3, Ch 2, Sec 4 402. 3 and 4 of the Rules** can be applied to the bulkhead deck or keel by using pitch connecting force( $F_p$ ) as shown in **Figure 3.1.5**. This force is as follows.

$$F_p = 0.5B_{CL} \frac{M_T}{n_{Fp}} \quad , \text{ where } n_{Fp} \text{ is number of frames}$$

Table 3-6 Load cases for longitudinal strength evaluation of catamaran

No.	Load cases		Pt 3, Ch 2 of the Rules
1	Vertical bending moment (Hogging)	$\text{Max}(M_{\text{hog}}, MB)$	401.2.(2), 401.4.(2)
2	Vertical bending moment (Sagging)	$\text{Max}(M_{\text{sag}}, MB)$	401.2.(3), 401.4.(2)
3	Transverse bending moment	MS	402.2.(2)
4	Longitudinal/transverse torsional moment	MP + MT	402.3 및 402.4
5	Load combination 1	$0.8 \text{ Max}(M_{\text{sag}}, MB) + 0.6(MP + MT)$	
6	Load combination 2	$0.6 \text{ Max}(M_{\text{sag}}, MB) + 0.8(MP + MT)$	
7	Load combination 3	$0.7M_s + (MP + MT)$	
8	Load combination 4	$M_s + 0.7(MP + Mt)$	

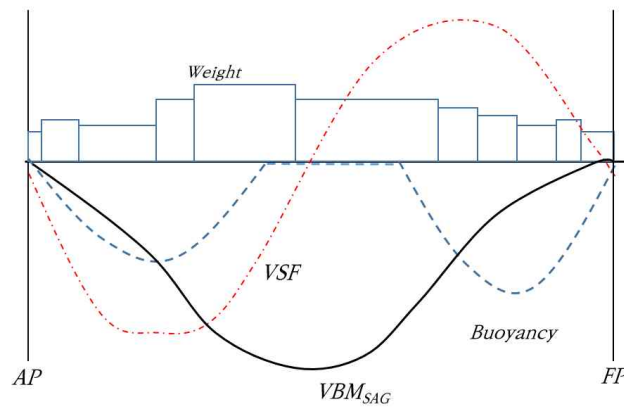

Figure 3.1.2 An example of weight, buoyancy, shear force and bending moment diagram (refer to Figure 3.2.11 of the Rules)

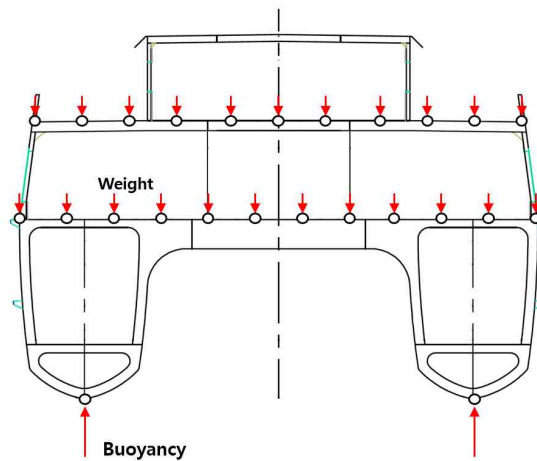

Figure 3.1.3 An example for application of weight and buoyancy



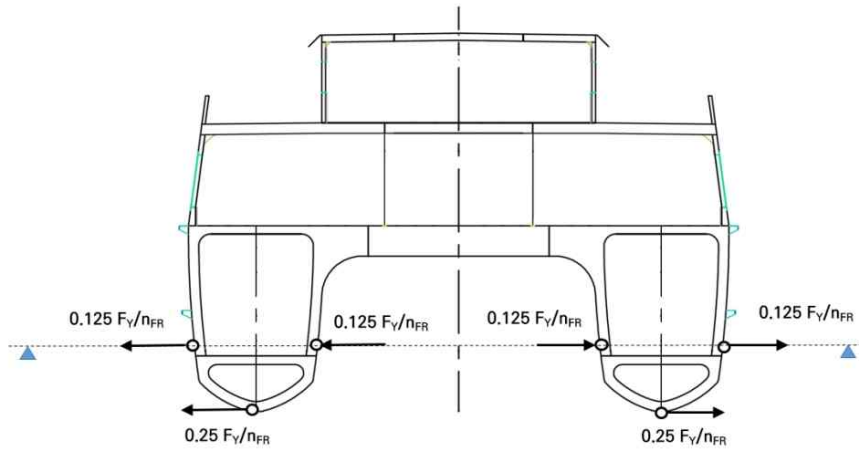

Figure 3.1.4 Application of horizontal split force for transverse bending moment ( $n_{FR}$  is no. of frames)

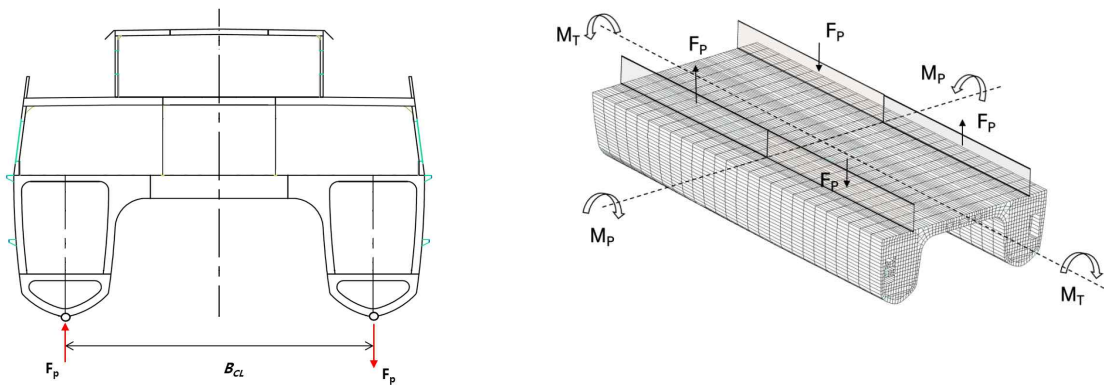

Figure 3.1.5 Application of pitch connecting force for longitudinal/transverse torsional moment

Table 3.5 Failure Strength Ratio,  $R$

Structural member	First ply failure ( $R$ )	Last ply failure ( $R$ )
Bottom panel exposed to slamming	1.5	3.3
Remaining bottom and inner bottom	1.5	3.3
Side structures	1.5	3.3
Deck structures	1.5	3.3
Bulkhead structures	1.5	3.3
Superstructures	1.5	3.3
Deckhouses	1.5	3.3
All structures exposed to longterm static loads	2.25	4.5

(NOTE) \*

The Tsai-Wu failure criterion in general 3 dimensional tensor form is written as:

$$(F_{ij} \sigma_i \sigma_j) R^2 + (F_i \sigma_i) R - 1 = 0, \quad i, j = 1, 2, 3, 4, 5, 6$$

The criterion is based on the following assumptions:

- linear relation between stresses and strains up to failure
- proportional increase of all stress components up to failure
- for an orthotropic laminate the criterion can be simplified to the following 2-dimensional form:

$$(F_{11}\sigma_1^2 + F_{22}\sigma_2^2 + F_{66}\sigma_{12}^2 + 2F_{12}\sigma_1\sigma_2) R^2 + (F_1\sigma_1 + F_2\sigma_2 + F_6\sigma_{12}) R - 1 = 0$$

The stress factors  $F$  are defined as below and must be determined from material testing.

$$F_1 = \frac{1}{x_t} + \frac{1}{x_c}, \quad F_2 = \frac{1}{y_t} + \frac{1}{y_c}, \quad F_6 = 0, \quad F_{11} = \frac{1}{x_t x_c}, \quad F_{22} = \frac{1}{y_t y_c}, \quad F_{66} = \frac{1}{S^2},$$

$F_{12}$  must be determined from biaxial tests. For the case where  $\sigma_1 = \sigma_2 = \sigma$

$$F_{12} = \frac{1}{2\sigma^2} \left[ 1 - \left( \frac{1}{x_t} + \frac{1}{x_c} + \frac{1}{y_t} + \frac{1}{y_c} \right) \sigma + \left( \frac{1}{x_t x_c} + \frac{1}{y_t y_c} \right) \sigma^2 \right]$$

When considered relevant, the term  $F_{12} = -0.5(F_{11} F_{22})^{1/2}$  may be used.

Notation:

$F$ : stress factor	$x_t$ : tensile strength in material direction 1
$x_c$ : compressive strength in material direction 1	$y_t$ : tensile strength in material direction 2
$y_c$ : compressive strength in material direction 2	$S$ : Shear strength in material direction 1, 2
$R$ : safety ratio	$\sigma_1$ : stress in material direction 1
$\sigma_2$ : stress in material direction 2	$\tau_{12}$ : Shear stress in material direction 1, 2



## Annex 3-2 Guidance for Buckling Strength Calculation

### 1. Buckling Strength Calculation for Steel Ships

(1) General

(A) Symbols used are as follows.

- $t$  : thickness of plating (mm)  
 $s$  : shortest side of plate panel (m)  
 $l$  : longest side of plate panel (m) (= length in m of stiffener, pillar, etc.)  
 $E$  : modulus of elasticity of the material (= 2.06·10<sup>5</sup> N/mm<sup>2</sup> for steel)  
 $\sigma_{el}$  : the ideal elastic (Euler) compressive buckling stress (N/mm<sup>2</sup>)  
 $\sigma_f$  : minimum upper yield stress of material (N/mm<sup>2</sup>), may be taken as 235 N/mm<sup>2</sup> for normal strength steel. For higher strength steel, the requirements specified in **Pt 3, Ch 3, 501.** are to be applied.  
 $\tau_{el}$  : the ideal elastic(Euler) shear buckling stress (N/mm<sup>2</sup>)  
 $\tau_f$  : minimum shear yield stress of material (=  $\frac{\sigma_f}{\sqrt{3}}$ ) (N/mm<sup>2</sup>)  
 $\sigma_c$  : the critical compressive buckling stress (N/mm<sup>2</sup>)  
 $\tau_c$  : the critical shear stress (N/mm<sup>2</sup>)  
 $\sigma_a$  : calculated actual compressive stress (N/mm<sup>2</sup>)  
 $\tau_a$  : calculated actual shear stress (N/mm<sup>2</sup>)  
 $\eta$  : stability(usage) factor  $\left( = \frac{\sigma_a}{\sigma_c} = \frac{\tau_a}{\tau_c} \right)$   
 $Z_n$  : vertical distance (m) from the baseline or deckline to the neutral axis of the hull girder, whichever is relevant  
 $Z_a$  : vertical distance (m) from the baseline or deckline to the point in question below or above the neutral axis, respectively.

(B) Relationships for buckling strength calculation are as follow.

- (a) when  $\sigma_d < \frac{\sigma_f}{2}$  :  $\sigma_c = \sigma_d$ ,      when  $\sigma_d > \frac{\sigma_f}{2}$  :  $\sigma_c = \sigma_f \left( 1 - \frac{\sigma_f}{4\sigma_d} \right)$   
 (b) when  $\tau_d < \frac{\tau_f}{2}$  :  $\tau_c = \tau_d$ ,      when  $\tau_d > \frac{\tau_f}{2}$  :  $\tau_c = \tau_f \left( 1 - \frac{\tau_f}{4\tau_d} \right)$

(c) when the required  $\sigma_c$  or  $\tau_c$  is known, the necessary  $\sigma_d$  or  $\tau_d$  will from the above expressions of Johnson-Ostenfeld relationship be:

$$\sigma_{el} = \frac{\sigma_c}{K_{J-O}} \text{ and } \tau_{el} = \frac{\tau_c}{K_{J-O}}$$

$K_{J-O}$  : from **Fig 3.1** or from the formula as follow.

$$K_{J-O} = 1 - \left( \frac{\sigma_c \text{ or } \tau_c}{0.5(\sigma_c \text{ or } \tau_c)} - 1 \right)^2$$

$$\text{For } \frac{\sigma_c}{\sigma_f} < 0.5, K_{J-O} = 1$$

(2) Longitudinal Buckling Load

For longitudinal stresses, the requirements specified in **Pt 3, Ch 2, 401.** are to be applied.

- (3) Transverse Buckling Load  
Transverse hull stresses in compression may occur from:
- (A) transverse loads and moments in twin hull craft, the requirements specified in **Pt 3, Ch 2, 402.** are to be applied.
  - (B) supports of craft's side structure, the requirements specified in **Pt 3, Ch 3, Sec 5** and **Sec 6** are to be applied.
- (4) Plating
- (A) Plate panel in uni-axial compression
    - (a) The ideal elastic buckling stress may be taken as:

$$\sigma_{el} = 0.9 k E \left( \frac{t}{1000s} \right)^2 \quad (\text{N/mm}^2)$$

$k$  : coefficient in accordance with **Table 3.6**

$c = 1.21$  (when stiffeners are angles or T-sections)

$= 1.10$  (when stiffeners are bulb flats)

$= 1.05$  (when stiffeners are flat bars)

For double bottom panels the  $c$ -values may be multiplied by 1.1

$\varphi$  : the ratio between the smaller and the larger compression stress assuming linear variation in accordance with **Table 3.2**

- (b) The critical buckling stress is to be related to the actual compression stresses as follows.

$$\sigma_c \geq \frac{\sigma_a}{\eta}$$

$\sigma_a$  : calculated compression stress in plate panels. With linearly varying stress across the plate panel,  $\sigma_a$  is to be taken as the largest stress

$\eta = 1.0$  : for deck, side, single bottom and longitudinal bulkhead plating

$= 0.9$  : for bottom and inner bottom plating in double bottoms

$= 1.0$  : for locally loaded plate panels where an extreme load level is applied

$= \eta_G \left( = \frac{p_s + 0.5p_d}{p_s + p_d} \right)$  : for locally loaded plate panels where a normal load level is applied

$p_s$  and  $p_d$  : static and dynamic parts of  $p$

- (c) The resulting thickness requirements, before elastic buckling, will be as follows.

- with stiffeners in direction of compression stress :  $t = 1.17s \sqrt{\frac{\sigma_c}{K_{J-O}}} \quad (\text{mm})$

- with stiffeners perpendicular to compression stress :

$$t = 2.33 \frac{s}{1 + \left( \frac{s}{l} \right)^2} \sqrt{\frac{\sigma_c}{cK_{J-O}}} \quad (\text{mm})$$

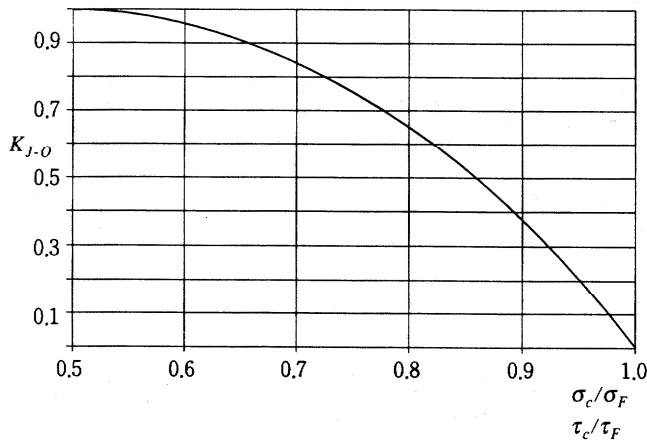

Fig 3.1 Factor  $K_{J-0}$

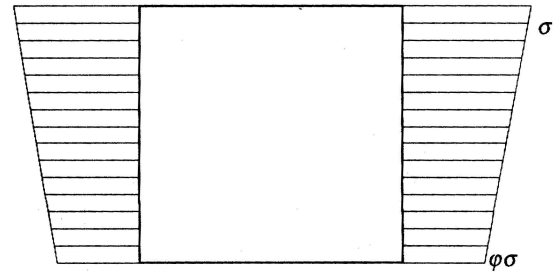

Fig 3.2 Buckling Stress Correction Factor

(B) Plate panel in shear

(a) The ideal elastic buckling stress may be taken as follows.

$$\tau_{el} = 0.9 k_t E \left( \frac{t}{1000 s} \right)^2 \quad (\text{N/mm}^2), \quad k_t = 5.34 + 4 \left( \frac{s}{l} \right)^2$$

(b) The critical shear stress is to be related to the actual shear stresses as follows.

$$\tau_c \geq \frac{\tau_a}{\eta}$$

- $\eta = 0.9$  : for craft's sides and longitudinal bulkheads subjected to hull girder shear forces
- $= 0.95 \eta_G$  : for local panels in girder webs when nominal shear stresses are calculated ( $\tau_a = Q/A$ )
- $= \eta_G$  : for local panels in girder webs when shear stresses are determined by finite element calculations or similar

(c) The resulting thickness requirement will be as follows.

$$t = 2.33 s \sqrt{\frac{\tau_c}{k_t K_{J-0}}} \quad (\text{mm})$$

(C) Plate panel in bi-axial compression and shear

(a) For plate panels subject to bi-axial compression and in addition to in-plane shear stresses the interaction is given as follows.

$$\frac{\sigma_{ax}}{\eta_x \sigma_{cx} q} - K \frac{\sigma_{ax} \sigma_{ay}}{\eta_x \eta_y \sigma_{cx} \sigma_{cy} q} + \left( \frac{\sigma_{ay}}{\eta_y \sigma_{cy} q} \right)^n \leq 1$$

- $\sigma_{ax}$  : compression stress in longitudinal direction (perpendicular to stiffener spacing  $s$ )
- $\sigma_{ay}$  : compression stress in transverse direction (perpendicular to the longer side  $l$  of the plate panel)
- $\sigma_{cx}$  : critical buckling stress in longitudinal direction (perpendicular to stiffener spacing  $s$ )

$\sigma_{cy}$  : critical buckling stress in transverse direction (perpendicular to the longer side  $l$  of the plate panel)

$\eta_x, \eta_y = 1.0$  : for plate panels where the longitudinal stress  $\sigma_a$  or other extreme stress is incorporated in and constitutes a major part of  $\sigma_{ax}$  or  $\sigma_{ay}$   
= 0.95  $\eta_G$  in other cases

$$K = c\beta^a$$

$c, a, n$  : factors given in **Table 3.7**

$$\beta = 1000 \frac{s}{t} \sqrt{\frac{\sigma_f}{E}}, \quad q = 1 - \left( \frac{\tau_a}{\eta_t \tau_c} \right)^2$$

$\eta_t = \eta$  : as specified in (B) (b) above

(b) Shear stresses are to be considered in combination with the follows cases.

- uni-axial compression may be written :  $\frac{\sigma_{ax}}{\sigma_{cx}}$  or  $\frac{\sigma_{ay}}{\sigma_{cy}} \leq (\eta_x \text{ or } \eta_y)q$

- bi-axial compression :  $\frac{\sigma_{ax}}{\eta_x \sigma_{cx}} + 1.1 \frac{\sigma_{ay}}{\eta_y \sigma_{cy}} - \frac{0.8}{\eta_x \eta_y} \frac{\sigma_{ax}}{\sigma_{cx}} \frac{\sigma_{ay}}{\sigma_{cy}} \leq q$

- for bi-axial compression alone :  $q = 1$

**Table 3.6 Factor ( $k$ )**

structure	Factor ( $k$ )
plating with longitudinal stiffeners (in the direction of compression stress)	$k = k_l = \frac{8.4}{\varphi + 1.1} \quad (0 \leq \varphi \leq 1)$
plating with transverse stiffeners (perpendicular to the compression stress)	$k = k_s = c \left[ 1 + \left( \frac{s}{l} \right)^2 \right]^2 \frac{2.1}{\varphi + 1.1} \quad (0 \leq \varphi \leq 1)$

**Table 3.7 Factors  $a, c$  and  $n$**

	$c$	$a$	$n$
$1.0 < l/s \leq 1.5$	0.78	-0.12	1.0
$1.5 < l/s < 8$	0.80	0.04	1.2

(5) Stiffeners in Direction of Compression

(A) Lateral buckling mode

(a) The ideal elastic lateral buckling stress may be taken as follow.

$$\sigma_{el} = 10 \frac{E}{\left(100 \frac{l}{i}\right)^2} \text{ (N/mm}^2\text{)}, \quad i = \sqrt{\frac{I_A}{A}}$$

$I_A$  : moment of inertia about the axis perpendicular to the expected direction of buckling ( $\text{cm}^4$ )

$A$  : cross-sectional area ( $\text{cm}^2$ )

(b) The formula for the critical buckling stress is as follows.

- When calculating  $I_A$  and  $A$ , a plate flange equal to 0.8 times the spacing is included for stiffeners.

- The critical buckling stress is to be in accordance with requirements specified in (1) (B).
  - The formula for the ideal elastic lateral buckling stress is based on hinged ends and axial force, only.
  - Continuous stiffeners supported by equally spaced girders are regarded as having hinged ends when considered for buckling.
  - In case of eccentric force, additional end moments or additional lateral pressure, the strength member is to be reinforced to withstand bending stresses.
- (c) For longitudinal structures, the critical buckling stress is the same as (A) (a) above and the actual compression stress is to be satisfied with the follows.

$$\sigma_c \geq \frac{\sigma_a}{\eta}$$

$\sigma_a$  : actual compression stress(N/mm<sup>2</sup>), for the local load stress, the value of stress divided by  $\eta_G$  specified in (4) (A) (b) above.

$h = 0.85$  : for continuous stiffeners  
 $= 1 - \eta_b$  : others, maximum 0.85

$$\eta_b = \frac{\text{simultaneous bending moment at midspan}}{\text{bending moment capacity}}$$

- (d) The resulting maximum allowable slenderness is to as follows.

$$100 \frac{l}{i} = 1435 \sqrt{\frac{K_{J-O}}{\sigma_c}}$$

(B) Torsional buckling mode

- (a) For longitudinal structures, the ideal elastic buckling stress for the torsional mode is to be in accordance with the separate requirements deemed appropriate by the Society.
- (b) The critical buckling stress is to be satisfied by the following conditions.

$$\sigma_c \geq \frac{\sigma_a}{\eta}$$

$\sigma_a$  : actual compression stress(N/mm<sup>2</sup>), for the local load stress, the value of stress divided by  $\eta_G$  specified in (4) (A) (b) above.

$\eta = 0.8$  : when the adjacent plating is allowed to buckle in the elastic mode, according to the requirements specified in (7).  
 $= 0.85$  : in general

- (c) To avoid torsional buckling, the dimension is to be decided according to the kind of stiffener.
- The height of flats should not exceed the follows.

$$h_w = t_w \frac{245}{\sqrt{\frac{\sigma_c}{K_{J-O}}}} \quad (\text{mm})$$

$t_w$  : thickness of web (mm)

- Flanged profiles are to be satisfied by the following conditions.

$$1 < \frac{h_w}{b_f} < 3$$

- Minimum flange breath should not to be less than the follows.

$$b_f = 3l \sqrt{\frac{\sigma_c}{K_{J-O}}} \quad (\text{mm}) \quad (\text{for symmetrical flanges})$$

$$b_f = 2l \sqrt{\frac{\sigma_c}{K_{J-O}}} \quad (\text{mm}) \quad (\text{for unsymmetrical flanges})$$

(C) Web and flange buckling

(a) The buckling stress required for the web is to be as follows.

$$\sigma_{el} = 3.8E \left( \frac{t_w}{h_w} \right)^2 \quad (\text{N/mm}^2)$$

$t_w$  and  $h_w$  : web thickness and height (mm)

(b) The ideal elastic buckling stress of flange of stiffeners is to be as follows.

$$\sigma_{el} = 3.8E \left( \frac{t_f}{b_f} \right)^2 \quad (\text{N/mm}^2)$$

$t_f$  : flange thickness (mm)

$b_f$  : flange width for angles, half the flange width for T-sections (mm)

(c) The flange thickness is to be in accordance with the requirements specified in (4) (A) (c).

(d) The flange width is to be as follows.

$$b_f < t_f \frac{245}{\sqrt{\frac{\sigma_c}{K_{J-O}}}} \quad (\text{mm})$$

(6) Stiffeners Perpendicular to Direction of Compression

For longitudinal structures, the moment of inertia of the stiffener section is not to be less than the follows.

$$I = \frac{0.09 \sigma_a \sigma_{el} l^4 s}{t} \quad (\text{cm}^4)$$

$l$  : span of stiffener (m)

$s$  : spacing of stiffener (m)

$t$  : plate thickness (mm)

$$\sigma_{el} = \frac{\sigma_c}{K_{J-O}}, \quad \sigma_c = \frac{\sigma_a}{0.85}$$

$\sigma_a$  : actual compression stress(N/mm<sup>2</sup>), for the local load stress, the value of stress divided by  $\eta_G$  specified in (4) (A) (b) above.

$K_{J-O}$  : according to **Fig 3.1**

(7) Elastic Buckling of Stiffened Panels

(A) Elastic buckling as a design basis

(a) Elastic buckling may be accepted for plating between stiffeners when ;



$$\sigma_{el} = \frac{\sigma_f}{2}, \quad \text{i.e. } \sigma_{el} = \sigma_c$$

-  $\eta \sigma_c$  (stiffener in direction of compression)  $>$   $\eta \sigma_{el}$  (plating in direction of compression)

$\eta \sigma_c$  : according to (5) and (1) (B). To be multiplied by  $\eta_G$  for ordinary local load.

$\eta \sigma_{el}$  : according to (4) (A) and (1) (B)

(b) The torsional buckling mode of flats is to be as follows.

$$\sigma_{el} = 0.385 E \left( \frac{t_w}{h_w} \right)^2 \quad (\text{N/mm}^2)$$

(B) Allowable compression

(a) The allowable compression force in the panel may be increased from  $P_{A1}$  to  $P_{A2}$ .

$$P_{A1} = 0.1 \eta_P \sigma_{el} (A_P + A_s) \quad (\text{KN})$$

$$P_{A2} = 0.1 \eta_P \sigma_{el} (A_P + A_s) + 0.1 (\eta_S \sigma_c - \eta_P \sigma_{el}) \left( \frac{b_e}{b} A_P + A_s \right) \quad (\text{kN})$$

$\eta_P$  and  $\eta_S = \eta$  : according to (4) (A) and (5).  $\eta_S$  to be multiplied by  $\eta_G$  for ordinary local load

$\sigma_{el}$  and  $\sigma_c$  : according to (4) (A) and (5). Ordinary effective flange is to be used for stiffeners

$A_p$  and  $A_s$  : area of plating and stiffener ( $\text{cm}^2$ )

$\frac{b_e}{b} = \frac{\sigma_u - \sigma_{el}}{\sigma_f - \sigma_{el}}$  : fraction of  $A_p$  participating in the post-buckling stress increase

$\sigma_u = \sigma_{el} \left[ 1 + 0.375 \left( \frac{\sigma_f}{\sigma_{el}} - 2 \right) \right]$  : ultimate average stress of plating

(b) For transversely stiffened plating, the ultimate average stress of plating is as follows.

$$\sigma_u = \sigma_{el} \left[ 1 + c \left( \frac{\sigma_f}{\sigma_{el}} - 2 \right) \right]$$

$$c = \frac{0.75}{\frac{l}{s} + 1}$$

$$A_s = 0$$

$$P_A = 0.1 \eta_P \sigma_u A_p \quad (\text{kN})$$

(c)  $\sigma_u$  may be substituted for  $\sigma_{el}$  when calculating bi-axial compression and shear in accordance with (4) (C).

(8) Girders

(A) Girders perpendicular to direction of compression

(a) When the compression stresses are applied on girders which support stiffeners, the moment of inertia of the girder section is not to be less than the follows.

$$I = 0.3 \frac{S^4}{l^3 s} I_s \quad (\text{cm}^4)$$

$S$  : span of girder (m)

- $l$  : distance between girder (m)  
 $s$  : spacing of stiffener (m)  
 $I_s$  : moment of inertia of stiffener (cm<sup>4</sup>)

$$\left( = \frac{\sigma_{el} A l^2}{0.001 E} \right)$$

$$\sigma_{el} = \frac{\sigma_c}{K_{J-O}}$$

$$\sigma_c = \frac{\sigma_a}{0.85}$$

$A$  : according to (5) (A) (a)

$K_{J-O}$  : according to (1) (B)

(B) Buckling of effective flange

- (a) Plating acting as effective flange for girders which support crossing stiffeners should have a satisfactory buckling strength.  
 (b) Compression stress arising in the plating due to local loading of girders are to be less than  $\eta_G \times$  critical buckling strength specified in (1) (B) and (4) (A). When calculating the compression stress, the effective flange is to be the distance between girders.  
 (c) Elastic buckling of deck plating may be accepted after special consideration.

**2. Buckling Strength Calculation for Aluminium Alloy**

(1) General

(A) Symbols

- $t$  : thickness of plating (mm)  
 $s$  : shortest side of plate panel (m)  
 $l$  : longest side of plate panel (m)  
 $E$  : modulus of elasticity of the material for aluminium (=0.69×10<sup>5</sup> N/mm<sup>2</sup>)  
 $\sigma_{el}$  : the ideal elastic (Euler) compressive buckling stress (N/mm<sup>2</sup>)  
 $\sigma_f$  : minimum upper yield stress of material (N/mm<sup>2</sup>)  
 usually base material properties are used, but critical or extensive zones may have to be taken into account.  
 $\tau_{el}$  : the ideal elastic (Euler) shear buckling stress (N/mm<sup>2</sup>)  
 $\tau_f$  : minimum shear yield stress of material ( $= \frac{\sigma_f}{\sqrt{3}}$ ) (N/mm<sup>2</sup>)  
 $\sigma_c$  : the critical compressive buckling stress (N/mm<sup>2</sup>)  
 $\tau_c$  : the critical shear stress (N/mm<sup>2</sup>)  
 $\sigma_a$  : calculated actual compressive stress (N/mm<sup>2</sup>)  
 $\tau_a$  : calculated actual shear stress (N/mm<sup>2</sup>)  
 $\eta$  : stability (usage) factor ( $= \frac{\sigma_a}{\sigma_c} = \frac{\tau_a}{\tau_c}$ )  
 $Z_n$  : vertical distance from the baseline or declinate to the neutral axis of the hull girder, whichever is relevant (m)  
 $Z_a$  : vertical distance from the baseline or declinate to the point in question below or above the neutral axis, respectively (m)

(B) Relationships

(a) when  $\sigma_{el} < \frac{\sigma_f}{2}$  ,  $\sigma_c = \sigma_{el}$  ,    when  $\sigma_{el} > \frac{\sigma_f}{2}$  ,  $\sigma_c = \sigma_f \left( 1 - \frac{\sigma_f}{4\sigma_{el}} \right)$

(b) when  $\tau_{el} < \frac{\tau_f}{2}$  ,  $\tau_c = \tau_{el}$  ,    when  $\tau_{el} > \frac{\tau_f}{2}$  ,  $\tau_c = \tau_f \left( 1 - \frac{\tau_f}{4\tau_{el}} \right)$

(c) When the required  $\sigma_c$  or  $\tau_c$  is known, the necessary  $\sigma_{el}$  or  $\tau_{el}$  will from the above expression of the Johnson-Ostenfeld relationship be

$$\sigma_{el} = \frac{\sigma_c}{K_{J-O}} \quad \text{and} \quad \tau_{el} = \frac{\tau_c}{K_{J-O}}$$

$K_{J-O}$  : from Fig 3.1 or from formula

$$K_{J-O} : 1 - \left( \frac{\sigma_c \text{ or } \tau_c}{0.5(\sigma_c \text{ or } \tau_c)} - 1 \right)^2$$

For  $\frac{\sigma_c}{\sigma_f} < 0.5$  ,  $K_{J-O} = 1$

(2) Longitudinal buckling load

See **Pt 3, Ch 2, 401.** of the Rules.

(3) Transverse buckling load

Transverse hull stresses in compression may occur from:

(A) transverse loads and moments in twin hull craft, see **Pt 3, Ch 2, 402.** of the Rules.

(B) supports of craft's side structure, see **Pt 3, Ch 4, Sec 7** of the Rules.

(4) Plating

(A) Plate panel in uni-axial compression

(a) The ideal elastic buckling stress may be taken as:

$$\sigma_{el} = 0.9 k E \left( \frac{1}{1000 s} \right)^2 \quad (\text{N/mm}^2)$$

$k$  : see **Table 3.6**

$c = 2.50$  (when stiffeners are hollow profile with  $s/l < 0.5$  and the enclosed area of the hollow profile is larger than 20 st)

$= 1.21$  (when stiffeners are angles or T-sections)

$= 1.10$  (when stiffeners are bulb flats)

$= 1.05$  (when stiffeners are flat bars)

For double bottom panels the  $c$ -values may be multiplied by 1.1.

$\varphi$  is the ratio between the smaller and the larger compressive stress assuming linear variation, see **Fig 3.2.**

(b) The critical buckling stress is to be related to the actual compressive stresses as follows:

$$\sigma_c \geq \frac{\sigma_a}{\eta}$$

$\sigma_a$  : calculated compressive stress in plate panels. With linearly varying stress across the plate panel,  $\sigma_a$  is to be taken as the largest stress.

$\eta = 1.0$  : for deck, side, single bottom and longitudinal bulkhead plating

$= 0.9$  : for bottom and inner bottom plating in double bottoms

$= 1.0$  : for locally loaded plate panels where an extreme load level is applied

$= \eta_G \left( = \frac{p_s + 0.5p_d}{p_s + p_d} \right)$  : for locally loaded plate panels where a normal load level is applied (e.g. plating acting as effective flange for girders)

$p_s$  and  $p_d$  : static and dynamic parts of  $p$ .

(c) The resulting thickness requirement (before elastic buckling) will be:

- with stiffeners in direction of compressive stress :  $t = 2s \sqrt{\frac{\sigma_c}{K_{J-O}}} \quad (\text{mm})$

- with stiffeners perpendicular to compressive stress : 
$$t = 4 \frac{s}{1 + \left(\frac{s}{l}\right)^2} \sqrt{\frac{\sigma_c}{cK_{J-O}}}$$

(B) Plate panel in shear

(a) The ideal elastic buckling stress may be taken as:

$$\tau_{el} = 0.9 K_t E \left( \frac{t}{1000s} \right)^2 \quad (\text{N/mm}^2), \quad K_t = 5.34 + 4 \left( \frac{s}{l} \right)^2$$

(b) The critical shear stress is to be related to the actual shear stresses as follows:

$$\tau_c \geq \frac{\tau_a}{\eta}$$

- $\eta = 0.9$  : for craft's side and longitudinal bulkhead subject to hull girder shear forces  
 $= 0.95 \eta_G$  : for local panels in girder webs when nominal shear stresses are calculated ( $\tau_a = Q/A$ )  
 $= \eta_G$  : for local panels in girder webs when shear stresses are determined by finite element calculations or similar

(c) The resulting thickness requirement will be:

$$t = 4s \sqrt{\frac{\tau_c}{k_t K_{J-O}}} \quad (\text{mm})$$

(C) Plate panel in bi-axial compression and shear

(a) For plate panels subject to bi-axial compression the interaction between the longitudinal and transverse buckling strength ratios is given by:

$$\frac{\sigma_{ax}}{\eta_x \sigma_{ax} q} - K \frac{\sigma_{ax} \sigma_{ay}}{\eta_x \eta_y \sigma_{ax} \sigma_{ay} q} + \left( \frac{\sigma_{ay}}{\eta_y \sigma_{ay} q} \right)^n \leq 1$$

$\sigma_{ax}$  : compressive stiffness in longitudinal direction (perpendicular to stiffener spacing  $s$ )  
 $\sigma_{ay}$  : compressive stress in transverse direction (perpendicular to the longer side  $l$  of the plate panel)

$\sigma_{cx}$  : critical buckling stress in longitudinal direction (perpendicular to stiffener spacing  $s$ )  
 $\sigma_{cy}$  : critical buckling stress in transverse direction (perpendicular to the longer side  $l$  of the plate panel)

$\eta_x, \eta_y = 1.0$  : for plate panels where the longitudinal stress  $\sigma_a$  or other extreme stress is incorporated and constitutes a major part in  $\sigma_{ax}$  or  $\sigma_{ay}$   
 $= 0.95 \eta_G$  : other cases

$$K = c \beta^a$$

$c, a, n$  : see **Table 3.7**

$$\beta = 1000 \frac{s}{t} \sqrt{\frac{\sigma_f}{E}}$$

$$q = 1 - \left( \frac{\tau_a}{\eta_t \tau_c} \right)^2$$

$\eta_i = \eta$  : as given (B) (b)

(b) For shear in combination with:

- uni-axial compression :  $\frac{\sigma_{ax}}{\sigma_{cx}}$  or  $\frac{\sigma_{ay}}{\sigma_{cy}} \leq (\eta_x \text{ or } \eta_y) q$

- bi-axial compression, approximately :  $\frac{\sigma_{ax}}{\eta_x \sigma_{cx}} + 1.1 \frac{\sigma_{ay}}{\eta_y \sigma_{cy}} - \frac{0.8}{\eta_x \eta_y} \frac{\sigma_{ax}}{\sigma_{cx}} \frac{\sigma_{ay}}{\sigma_{cy}} \leq q$

- for bi-axial compression alone  $q = 1$

(5) Stiffeners in Direction of Compression

(A) Lateral buckling mode

(a) The ideal elastic lateral buckling stress may be taken as:

$$\sigma_{el} = 10 \frac{E}{\left(100 \frac{l}{i}\right)^2} \quad (\text{N/mm}^2)$$

$$i = \sqrt{\frac{I_A}{A}}$$

$I_A$  : moment of inertia about the axis perpendicular to the expected direction of buckling (cm<sup>4</sup>)

$A$  : cross-sectional area (cm<sup>2</sup>)

(b) Critical buckling stress is as follows:

- When calculating  $I_A$  and  $A$ , a plate range breadth equal to 0.8 times the spacing is included for stiffeners.

- The critical buckling stress is found from (1) (B).

- The formula given for  $\sigma_{el}$  is based on hinged ends and axial force only.

- Continuous stiffeners supported by equally spaced girders are regarded as having hinged ends when considered for buckling.

- In case of eccentric force, additional end moments or additional lateral pressure, the strength member is to be reinforced to withstand bending stresses.

(c) For longitudinals and other stiffeners in the direction of compressive stresses, the critical buckling stress calculated in (A) is to be related to the actual compressive stress as follows:

$$\sigma_c \geq \frac{\sigma_a}{\eta}$$

$\sigma_a$  : calculated extreme compressive stress, or ordinary local load stress divided by  $\eta_G$ .

**4. (A) (b)**

$\eta = 0.85$  : for continuous stiffeners

$= 1 - \eta_b$  : maximum 0.85 for single-span stiffeners

$$\eta_b = \frac{\text{simultaneous bending moment at midspan}}{\text{bending moment capacity}}$$

(d) The resulting maximum allowable slenderness will be:

$$100 \frac{l}{i} = 830 \sqrt{\frac{K_{J-O}}{\sigma_c}}$$

(B) Torsional buckling mode

(a) For longitudinals and other stiffeners in the direction of compressive stresses, the ideal elastic buckling stress for the torsional mode may in general be followed the appropriate

requirements of the Rules.

- (b) The critical buckling stress is not to be less than:

$$\sigma_c \geq \frac{\sigma_a}{\eta}$$

$\sigma_a$  : calculated extreme compressive stress, or ordinary local load stress divided by  $\eta_G$ ,

4. (A) (b)

$\eta = 0.8$  : when the adjacent plating is allowed to buckle in the elastic mode, according to (7)

= 0.85 : in general

- (c) To avoid torsional buckling the following scantling is to keep:

- the height of flats should not exceed:

$$h_w = t_w \frac{140}{\sqrt{\frac{\sigma_c}{K_{J-O}}}} \quad (\text{mm})$$

$t_w$  : thickness of web (mm)

- For flanged profiles,

$$1 < \frac{h_w}{b_f} < 3$$

- Minimum flange breadth may be taken as:

$$b_f = 5l \sqrt{\frac{\sigma_c}{K_{J-O}}} \quad (\text{mm}) \quad (\text{For symmetrical flanges})$$

$$b_f = 3.5l \sqrt{\frac{\sigma_c}{K_{J-O}}} \quad (\text{mm}) \quad (\text{For unsymmetrical flanges})$$

(C) Web and flange buckling

- (a) The  $\sigma_{el}$  value required for the web buckling mode may be taken as:

$$\sigma_{el} = 3.8 E \left( \frac{t_w}{h_w} \right)^2 \quad (\text{mm})$$

$t_w$  and  $h_w$  : web thickness and height (mm)

- (b) The ideal elastic buckling stress of flange of angle and tee stiffeners may be calculated from the following formula:

$$\sigma_{el} = 0.38 E \left( \frac{t_f}{b_f} \right)^2 \quad (\text{N/mm}^2)$$

$t_f$  : flange thickness (mm)

$b_f$  : flange width for angles, half the flange width for T-sections

- (c) Web thickness, see plating with stiffener in direction of compression stress, (4) (A) (c).

- (d) Flange width from web:

$$b_f < t_f \frac{140}{\sqrt{\frac{\sigma_c}{K_{J-O}}}}$$

(6) Stiffeners perpendicular to direction of compression

For stiffeners supporting plating subject to compression stresses perpendicular to the stiffener direction the moment of inertia of the stiffener section (including effective plate flange) is not to be less than:

$$I = \frac{0.81 \sigma_a \sigma_{el} l^4 s}{t} \quad (\text{cm}^4)$$

$l$  : span of stiffener (m)

$s$  : spacing of stiffener (m)

$t$  : plate thickness (mm)

$$\sigma_{el} = \frac{\sigma_c}{K_{J-O}}$$

$$\sigma_c = \frac{\sigma_a}{0.85}$$

$\sigma_a$  : calculated extreme compressive stress, or ordinary local load stress divided by  $\eta_G$

$K_{J-O}$  : Fig 3.1

(7) Elastic buckling of stiffened panels

(A) Elastic buckling as a design basis

(a) Elastic buckling may be accepted for plating between stiffeners when:

$$- \sigma_{el} < \frac{\sigma_f}{2}, \text{ i.e. } \sigma_{el} = \sigma_c$$

-  $\eta \sigma_c$  (of stiffener in direction of compression)  $> h \sigma_{el}$  (of plating in direction of compression)

$\eta \sigma_c$  : from (5) and (1) (B). To be multiplied by  $\eta_G$  for ordinary local load.

$\eta \sigma_{el}$  : from (4) (A) or (1) (B)

(b) For the torsional buckling mode of flats may be taken:

$$\sigma_{el} = 0385 E \left( \frac{t_w}{h_w} \right)^2 \quad (\text{N/mm}^2)$$

(B) Allowable compression

(a) The allowable compressive force in the panel may be increased from  $P_{A1}$  to  $P_{A2}$ .

$$P_{A1} = 0.1 \eta_P \sigma_{el} (A_P + A_s) \quad (\text{KN})$$

$$P_{A2} = 0.1 \eta_P \sigma_{el} (A_P + A_s) + 0.1 (\eta_s \sigma_c - \eta_P \sigma_{el}) \left( \frac{b_c}{b} A_P + A_s \right) \quad (\text{KN})$$

$\eta_P$  and  $\eta_s = \eta$  : for plating and stiffener from (4) and (5).  $\eta_s$  to be multiplied by  $\eta_G$  for ordinary local load.

$\sigma_{el}$  and  $\sigma_c$  : for plating and stiffener, respectively, from (4)의 (A) and (D). Ordinary effective flange is to be used for stiffeners

$A_p$  and  $A_s$  : area of plating and stiffener (cm<sup>2</sup>)

$\frac{b_c}{b} = \frac{\sigma_u - \sigma_{el}}{\sigma_f - \sigma_{el}}$  : fraction of  $A_p$  participating in the post-buckling stress increase

$\sigma_u = \sigma_{el} \left[ 1 + 0.375 \left( \frac{\sigma_f}{\sigma_{el}} - 2 \right) \right]$  : ultimate average stress of plating

(b) For transversely stiffened plating (compressive stress perpendicular to longest side  $l$  of plate panel) is

$$\sigma_u = \sigma_{el} \left[ 1 + c \left( \frac{\sigma_f}{\sigma_{el}} - 2 \right) \right]$$

$$c = \frac{0.75}{\frac{l}{s} + 1}$$

$$A_s = 0$$

$$P_a = 0.1 \eta_P \sigma_u A_p \quad (\text{kN})$$

(c)  $\sigma_u$  may be substituted for  $\sigma_{el}$  when calculating uniaxial compression and shear (4) (C)

(8) Girders

(A) Girders perpendicular to direction of compression

(a) For transverse girders supporting longitudinals or stiffeners subject to axial compression stresses, the ideal elastic buckling stress may be taken as:

$$\sigma_{el} = 1.38 \frac{\pi^2}{S^2(t-t_a)} \sqrt{\frac{I_a I_b}{s \cdot l}} \quad (\text{N/mm}^2)$$

$S$  : span of girder (m)

$l$  : distance between girders (m)

$s$  : spacing of stiffeners (m)

$I_a$  : moment of inertia of stiffener (cm<sup>4</sup>)

$I_b$  : moment of inertia of transverse girder (cm<sup>4</sup>)

$t_a$  : equivalent plate thickness of stiffener area (mm) (= stiffener area / stiffener spacing)

(b) The critical buckling stress is not to be less than:

$$\sigma_c \geq \frac{\sigma_a}{\eta}$$

$\sigma_a$  : calculated compressive stress (N/mm<sup>2</sup>)

$$\eta = 0.75$$

(B) Buckling of effective flange

(i) Plating acting as effective flange for girders which support crossing stiffeners is to have a satisfactory buckling strength.



- 
- (ii) Compressive stresses arising in the plating due to local loading of girders are to be less than " $\eta_G$  x the critical buckling strength". When calculating the compressive stress the section modulus of the girder may be based on a plate range breadth equal to the distance between girders.
  - (iii) Elastic buckling of deck plating may be accepted after special consideration. ↓

## CHAPTER 2 DESIGN LOADS

### Section 4 Hull Girder Loads

#### 402. Twin hull loads

##### 2. Transverse bending moment and shear force

- (4) For craft with length  $L \geq 50$  m the twin hull still water transverse bending moment shall be assumed to be:

$$M_{SO} = 4.91 \Delta (y_b - 0.4B^{0.88}) \quad (\text{kN} \cdot \text{m})$$

$y_b$  : Distance in m from centre line to local centre line of one hull (See Fig.3.2.1) ↓

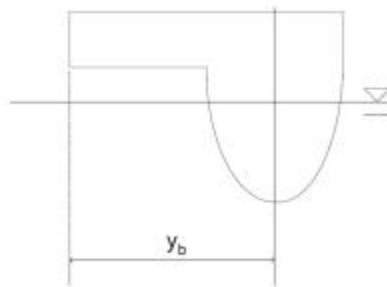

Fig 3.2.1 Definition  $y_b$  of local geometry for one hull on twin hull craft

## CHAPTER 4 STRUCTURE PRINCIPLES IN ALUMINIUM ALLOY

### Section 4 Hull Girder Strength

#### 401. Application

Material factor ( $K$ ) is to be as follows. ↓

**Table 3.4.1 Factor  $K$  for Wrought Aluminium Alloy Plates** ( $2 \text{ mm} \leq t \leq 40 \text{ mm}$ )

Grade	Temper condition	$K$
A 5052 P	H32	1.64
	H34	1.45
A 5154A P	O, H111	2.86
A 5454 P	H32	1.37
	H34	1.27
A 5086 P	H116, H32	1.25
	H34	1.14
A 5083 P	H116, H321	1.12
(Remarks) For temper condition O and H111, the factor $K$ is to be taken from <b>Table 3.4.4</b>		

**Table 3.4.2 Factor  $K$  for Aluminium Alloy Extruded Shapes** ( Note : when the main loading direction is longitudinal to the extrusion ) ( $2 \text{ mm} \leq t \leq 25 \text{ mm}$ )

Grade	Temper condition	$K$
A 6061 S	T5/T6	1.32
A 6005A S	T5/T6	1.32
A 6082 S	T5/T6	1.11

**Table 3.4.3 Factor  $K$  for Aluminium Alloy Extruded Shapes** ( Note : when the main loading direction is transverse to the extrusion ) ( $2 \text{ mm} \leq t \leq 25 \text{ mm}$ )

Grade	Temper condition	$K$
A 6061 S	T5/T6	1.41
A 6005A S	T5/T6	1.32
	$6 \leq t \leq 10$	
	$10 \leq t \leq 25$	1.49
A 6082 S	T5/T6	1.18

Table 3.4.4 Factor  $K$  in the Welded Condition

Grade	Temper condition	Welding consumables	$K$
A 5052	O, H111, H32, H34	A 5356 BY/WY	3.70
A 5154A	O, H111	A5356- A5183BY/WY	2.86
A 5454	O, H111, H32, H34	A5356- A5183BY/WY	2.86
A 5086	O, H111, H116, H32, H34	A5356- A5183BY/WY	2.38
A 5083	H116, H321, H116, H321	A 5356 BY/WY A 5183 BY/WY	1.89 1.67
A 6061	T5/T6	A5356- A5183BY/WY	2.08
A 6005A	T5/T6	A5356- A5183BY/WY	2.08
A 6082	T5/T6	A5356- A5183BY/WY	2.08

---

## CHAPTER 5 STRUCTURE PRINCIPLES IN FRP

### Section 1 General

#### 101. Application

1. The scantlings for hull structure's members of ship 60 m or more in length are in accordance with **Annex 3-1, Guidance for the Direct Strength Assessment.** ↓

**PART 4**  
**HULL EQUIPMENT**

## CHAPTER 3 EQUIPMENT NUMBER AND EQUIPMENT

### Section 1 General

1. For a ship of less than 30 m in length, if Danforth anchor is intended to be provided with special shaped construction and dimension, the relevant drawings shall be submitted to the Society and to be approved before manufacturing.
2. Where the equipment number is calculated in accordance with Pt 3, Ch 1, Sec 57, Para 2 of Ship's Equipment Standards to Korean Ship Safety Act the requirement given in **Table 4.3.1.** shall be applied for Danforth anchor, Anchor rope, Tow line and Mooring rope. etc.
3. The dimensions of Danforth anchor shall be in accordance with **Table 4.3.2,** except other Danforth anchor with different size and construction which shall be appropriate to the requirement of the Society. ⚡

**Table 4.3.1 Danforth anchor and Rope**

Equipment number		Danforth anchor		Lock used for anchor (per an anchor)						Tow line (standards of manila rope)		Mooring rope (standards of manila rope)			
Exceeding	Not exceeding	Number	Masst (kg)	Length (m)	Diameter (mm)						Length (m)	Diameter (mm)	Number	Length (m)	Diameter (mm)
					Manilar ope	Nylon rope	vinyl rope	Chain							
								Grade 1	Grade 2						
80	90	2	20	60	24	17	20	.	.	110	28	.	.	.	
90	105	2	25	70	28	20	24	.	.	110	30	1	165	20	
105	140	2	30	80	32	22	27	.	.	110	32	1	165	20	
140	175	2	40	90	35	25	30	.	.	135	34	1	165	22	
175	215	2	50	100	38	27	33	.	.	135	36	1	165	24	
215	255	2	60	100	42	30	36	14	12.5	135	40	1	165	24	
255	295	2	70	110	45	32	38	14	12.5	135	45	1	165	24	
295	390	2	95	110	50	35	42	16	14	135	50	1	165	32	
390	445	2	125	120	60	42	50	17.5	16	135	50	1	165	32	

Table 4.3.2 Each Dimension of Danforth anchor

Mass(kg) \ Dimension(mm)	A	B	C	D	E	F	G
20	825	463	361	685	95	18	23
25	890	500	390	740	104	20	25
30	945	565	414	784	109	21	26
40	1,049	590	460	872	122	24	29
50	1,154	647	506	960	134	26	32
60	1,190	668	521	988	137	27	33
75	1,280	719	561	1,063	149	29	35
100	1,400	790	616	1,170	163	31	43
120	1,500	840	657	1,240	174	34	45

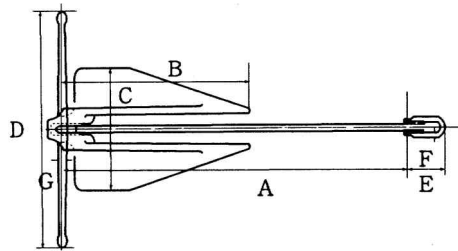

- A : Anchor Shaft(Shank) Length
- B : Bill(pea) ↔ Stock Center
- C : Anchor Arm(p) ↔ Anchor Arm.(s)
- D : Stock Length
- E : Anchor Ring(Shackle) Length
- F : Anchor Ring(Shackle) Dia.
- G : Stock Dia.



**PART 5**  
**MACHINERY SYSTEM**

---

## CHAPTER 1 GENERAL

### Section 1 General

#### 101. Application

1. In application to **101. 2** of the Rules, where a ship registered with service restriction notations of equipment "C" is taking back-up starting system of generator and those battery starting including independent spare battery, or a ship registered with service restriction notation of equipment "S" it shall not be applied to **Pt 5, Ch 1, Sec 103, 3** of the Rules. ⤴

## CHAPTER 2 AUXILIARIES AND PIPING ARRANGEMENT

### Section 1 General

#### 102. Materials for piping arrangement

1. In application to **102, 2** and **3** of the Rules, the term "required by the Society" means cases as specified in **Pt 5, Ch 6, Sec 102, 3** of **Guidance for the Classification of Steel Ships**. However, aluminium alloy pipes may be used for following cases only in case where hull is made of aluminium.
  - (1) Any pipe penetrating either A class division or B class division
  - (2) Air pipes, overflow pipes and Sounding pipes to the tanks which do not form part of ship's structure
  - (3) Bilge pipes and ballast water pipes which are not included in pipes which directly affect water ingress by damage when fire.

### Section 2 Bilge Pumping System

#### 204. Bilge pumps

1. In application to **204, 1** of the Rules, a ship registered with service restriction notations of equipment ("C" or "S") shall be applied to **Table 5.2.1.** (2020)
2. In application to **204, 3** of the Rules, where main bilge pipe is not provided in the bilge pumping system, with the exception of the space in front of the public space and crew space, at least one fixed submersible pump shall be fitted for each space. In addition for bilge pumping of each space at least one portable pump shall be provided, supplied from emergency supply if electric for use. The capacity  $Q_n$  of each submersible pump is to be not less than required by the following formula or 8.0 m<sup>3</sup>/h whichever is the more.

$$Q_n = Q / (N - 1) \text{ tonne/h}$$

where,

$N$  = number of submersible pumps

$Q$  = total capacity as defined **204., 3** of the Rules

Table 5.2.1 Number of Bilge Pumps

Length of ship(L)	Power bilge pump		Manual pump	Remarks
	Main engine driven pump	Independent power pump		
$L < 25$ m	1 set	—	1 set	The main engine driven pump may be omitted according to the discretion of the Society. In case ships less than 10 m, a bucket may be provided instead of a pump.(※)
$25 \text{ m} \leq L < 30$ m	1 set	1 set	—	2 sets of manual pumps may be provided instead of the main engine driven pump. Where ships is difficult to be provided with the independent power pump, the independent power pump may be omitted by considering piping system and capacity of other pumps.(※)
$30 \text{ m} \leq L < 50$ m	1 set	1 set	—	2 sets of manual pumps may be provided instead of the main engine driven pump.

(Note)

1. The requirement with mark (※) is to be applied to ships other than passenger ship.
2. In this Table, power pump may be provided instead of manual pump, and independent power pump may be provided instead of main engine driven pump.
3. In ships having length 25 m or over, but less than 30 m, the requirement for omission of independent power pump is to be applied to ships difficult to be provided with the independent power pump, provided with main engine driven pump having capacity more than suction capacity required by independent power pump, and arranged bilge piping in all compartment required bilge discharge. Where the hand pump is substituted for main engine driven pump, the independent power pump may be omitted.
4. In ships having coastal service area, the bilge pump for oil filtering equipment may be recognized as a manual bilge pump.
5. All power pumps and manual pumps are to discharge bilge from cargo hold, engine room and shaft tunnel.
6. For ships of less than 25 m in length other than passenger ship, one of the two bilge pumps may be installed manually, even if the capacity of pump is above 1.5 m<sup>3</sup>/hr.
7. For catamaran passenger ships, one bilge pump may be provided for each hull.

## Section 4 Ship-side Valves and Overboard Discharges

### 401. Scupper, inlets and discharges

1. In application to **401, 10** of the Rules, for a ship not engaging on international voyages, main and auxiliary sea inlets and discharges in connection with the operation of machinery in unmanned spaces may be controlled locally. In this case, such controls are to be readily accessible and are to be provided with indicators showing whether the valves are open or closed. ↓

## CHAPTER 3 PRIME MOVERS, POWER TRANSMISSION SYSTEMS AND LIFT DEVICES, ETC.

### Section 1 General

#### 101. Application

1. In application to **Ch 3, Sec 101, 1** of the Rules, it shall be complied with the requirement of **Pt 5, Ch 3, 203** and **204** of **Rules for the Classification of Steel Ships**.

(1) Intermediate shaft and thrust shaft

(A) The diameter  $d_o$  of intermediate shaft and thrust shaft shall be not less than

$$d_o = F \cdot K_1 \cdot \sqrt[3]{\frac{P}{n} \cdot \frac{560}{(t+160)}} \quad (\text{mm})$$

$P, n, F, T, K_1$  : according to **Pt 5, Ch 3, 203** of **Rules for the Classification of Steel Ships**.

(B) For ship restricted in coastal service, it may be reduced to 95 % of values calculated by (a) above.

(2) Propeller shaft and stern tube shaft

(A) The diameter  $d_p$  of propeller shaft and stern tube shaft with effective protection against sea-water corrosion shall be not less than

$$d_p = K_5 \cdot \sqrt[3]{\frac{P}{n}} \quad (\text{mm})$$

$P, n, F, K_2$  : according to **Pt 5, Ch 3, 203** and **204** of **Rules for the Classification of Steel Ships**

$K_m$  : factor concerning material of shaft as follows

$$K_m = \sqrt[3]{\frac{560}{T + 160}}$$

$T$  : specified minimum tensile strength ( $\text{N/mm}^2$ ) of proposed material. For the tensile strength exceeding  $800 \text{ N/mm}^2$ ,  $T$  is to be taken  $800 \text{ N/mm}^2$ .

(B) For propeller shaft and stern tube shaft with corrosion-resistant materials or without effective protection against seawater corrosion it shall be applied to **Pt 5, Ch 3, 204** of **Guidance for the Classification of Steel Ships**.

(C) For a ship of 25 m in length and belows, the following formula shall be complied with

$$d_p = K_s \cdot \sqrt[3]{\frac{P}{n}} \quad (\text{mm})$$

$P, n$  : according to **Pt 5, Ch 3, 204** of **Rules for the Classification of Steel Ships**

$K_s$  : factor concerning material of shaft is to be complied with the requirement given in **Table 5.3.1** of the Guidance

(D) For a ship restricted in coastal service, it may be reduced to 95 % of values calculated by (A) or (B) above.

2. In application to **Ch 3, 101, 1** of the Rules, in the case of a ship having two or more engine rooms, FRP may be used as the material for shafting systems if the ship can maintain navigable speed even in the event of a fire in one engine room. In case that FRP is used as the material for shafting systems, documents of strength evaluation including fatigue evaluation are to be submitted in

consideration of the characteristics of FRP. For materials, the relevant provisions of **Pt 2, Annex 2-8** of the **Guidance relating to the Rules for the Classification of Steel Ships** are to apply with appropriate modifications. (2022) ↓

**Table 5.3.1 Factor  $K_5$  Concerning Material of Shaft**

Shaft material		Specified minimum yield strength (N/mm <sup>2</sup> )	Specified minimum tensile strength (N/mm <sup>2</sup> )	$K_5$		
Material	Chemical composition (%)			Application 1 <sup>(1)</sup>	Application 2 <sup>(1)(2)</sup>	Stern tube shaft
Carbon steels or Carbon Manganese steels	According to <b>Pt 2, Ch 1.</b>	200	400	126	114	114
Authentic-stainless steels (KS STS 316 series)		175	470	91	81	81
Martensitic-stainless steels (KS STS 431 series)	C : 0.20 max Si : 0.80 Mn : 1.0 Ni : 2.0-3.0 Cr : 15.0-18.0	675	850	88	80	80
Duplex stainless steels	(3)	470	660	63	57	57
Manganese bronze copper	Cu : 52-62 Pb : 0.5 max Mn : 2.0 max Fe : 1.20 max Zn : remains	245	510	92	84	84
Nikel - Aluminum bronze copper	Ni : 4.0-6.0 Al : 7.0-11.0 Fe : 2.0-6.0 Nn : 2.0 max Cu : remains	390	740	85	77	77
Nikel-copper alloy	Ni : 63-68 Fe : 3.0 max Mn : 2.0 max C : 0.30 max Cu : remains	350	550	85	77	77
Nikel-copper alloy	Ni : 63-70 Al : 2.0-4.0 Fe : 2.0 max Mn : 1.5 max C : 0.25 max Cu : remains	690	960	71	64	64
(NOTES)						
(1) For application 1 and 2, it is to be referred to the requirement of <b>Table 5.3.1</b> of the Guidance.						
(2) For stern tube sealing devices at the forward side, from the forward end to intermediate shaft coupling it may be reduced to the required diameter of the intermediate shaft.						
(3) For the composition and characteristics, it is to be complied with the requirement recognized by the Society.						

**PART 6**  
**ELECTRICAL EQUIPMENT AND CONTROL**  
**SYSTEMS**

## CHAPTER 1 ELECTRICAL EQUIPMENT

### Section 1 General

#### 101. Application

1. In application to **101, 2** of the Rules, it shall be applied to HSC code as follows,
  - (1) When one generator given in HSC Code 12.2.2 is failure, the electric from other generator shall is supplied to electrical equipment as follows,
    - (A) Essential auxiliaries related to the propulsion of the ships and safety of lives and ships (refer to **Pt 5, Ch 1, 102, 1 of Guidance for the Classification of Steel Ships**. however, except not pertaining to components of main propulsion system such as thrust, windlass, mooring winch, provision refrigerator)
    - (B) Lifting
    - (C) Launching devices for survival craft
    - (D) Emergency fire pump
    - (E) Open and close devices of watertight door
    - (F) Automatic sprinkler devices
    - (G) Draught fan
    - (H) Navigation aids
    - (I) Inboard lighting equipment
    - (J) Radio installations
    - (K) Air-conditioning heater
    - (L) Sanitary pump
    - (M) Potable water pump and evaporator
    - (N) Sewage treatment plant
    - (O) Cooking equipment (ranges, electric cooking utensils, etc.)
  - (2) In application to (1) above, for a ship restricted in coastal service (registered with service restriction notations of equipment "C" or "S") and a passenger ship registered with service restriction notations of equipment "S", the electrical equipments shall be supplied with the requirements of (1), (A) to (1), (J) above.
  - (3) In accordance with the requirement of HSC Code 12.6.4.2, for all electric cables and wiring required not to impair their original flame-retarding properties, they shall be complied with **Pt 6, Ch 1, 504, 3 of Rules for the Classification of Steel Ships** to protect against fire, however, except ships not engaged on international voyages.

### Section 2 Electric Equipment

#### 202. Emergency electrical equipment

1. In application to **202, 2** (1) of the Rules, for category A craft not engaged on international voyages, it shall alternatively be applied for the following services and supplying period.
  - (1) For a period of 3 hours
    - (A) Emergency lighting at embarkation into lifeboat, etc.
    - (B) Emergency lighting system
    - (C) Ships light
    - (D) Fire detection and alarm system
  - (2) For a period of 30 minutes
    - (A) Whistle
    - (B) General alarm system
    - (C) Radio facilities



### 203. Stabilization system of craft

1. In application to 203. of the Rules, for stabilization system of craft (hereinafter refer to as "stabilization system") it shall be complied with as following requirements,
  - (1) Definition
    - (A) **"Stabilization control system"** is a system intended to stabilize the main parameters of the crafts attitude : heel, trim, course and height and control the craft's motions : roll, pitch, yaw and heave. This term excludes devices not associated with the safe operation of the craft, e.g. motion reduction or ride control systems in order to improve a great convenience. The main elements of a stabilization control system may include the following.
      - (a) devices such as rudders, foils, flaps, skirts, fans, water jets, tilting and steerable propellers, pumps for moving fluid, etc.
      - (b) power drives actuating stabilization devices ; and
      - (c) stabilization equipment for accumulating and processing data for making decisions and giving commands such as sensors, logic processors and automatic safety control.
    - (B) **"Self-stabilization"** is stabilization ensured solely by the craft's inherent characteristics.
    - (C) **"Forced stabilization"** is stabilization achieved by
      - (a) an automatic control system ; or
      - (b) a manually control assisted system ; or
      - (c) a combined system incorporating elements of both automatic and manually assisted control systems
    - (D) **"Augmented stabilization"** is a combined of self-stabilization and forced stabilization.
    - (E) **"Stabilization device"** means a device as given in (A) (a) with the aid of which forces for controlling the craft's position are generated.
    - (F) **"Automatic safety control"** is a logic unit for processing data and making decisions to put the craft into the displacement or other safe mode if a condition impairing safety arises.
  - (2) Lateral and height control systems
    - (A) Craft with an automatic control system should be provided with an automatic safety control plan Probable malfunctions should have only minor effects on automatic control system operation and should be capable of being readily counteracted by the operating crew.
    - (B) The parameters and levels at which any automatic control system gives the command to decrease speed and put the craft safety into the displacement or other safe mode should take account of the safety level and of the safe values of motions appropriate to the particular craft and service.
  - (3) Performance verification
    - (A) The limits of safe use of any of the stabilization control system devices should be based on demonstration and verification process in accordance with HSC Code 16.4.1
    - (B) Demonstration in accordance with HSC Code 16.4.1 should determine any adverse effects upon safe operation of the craft in the event of an uncontrollable total deflection of any one control device. Any limitation on the operation of the craft as may be necessary to ensure that the redundancy or safeguards in the systems provide equivalent safety should be included in the craft operating manual.
2. In application to 203, 1 of the Rules, a ship not engaged on international voyages shall be not applied. ↓

---

## CHAPTER 2 CONTROL SYSTEMS

### Section 1 General

#### 101. Application

1. In application to **101. 2** of the Rules, for a ship restricted in service area without pertaining to the requirements of Korean Ship Safety Act, it shall not be applied to the requirements of HSC Code 11.2.4 (remote control system for category B and cargo craft)

#### 102. Stabilization control system

1. In addition to **202.** of the Rules, it shall also be complied with the following requirements.
  - (1) In case of failure of any automatic equipment or stabilization device, or its power drive, the parameters of craft motion shall remain within safe limits.
  - (2) A failure mode and effect analysis shall include the stabilization control system. ↓

**PART 7**  
**FIRE PROTECTION, DETECTION AND**  
**EXTINCTION**

## CHAPTER 1 FIRE PROTECTION

### Section 2 Structural Fire Protection

#### 201. Classification of space use and structural fire protection times

1. In application to **201.** of the Rules, cabinets having a deck area of less than 2 m<sup>2</sup> may be accepted as part of the space they serve provided they have open ventilation to the space and do not contain any material or equipment which could be a fire risk.

Also, in application to NOTES 1 of **Table 7.1.1** and **Table 7.1.2** of the Rules, the upper side of the decks of open vehicle spaces need not be insulated where the fixed pressure water-spraying fire-extinguishing systems are provided.

2. Ventilation openings may be accepted in entrance doors to public toilets if positioned in the lower portion of such doors and fitted with closable grilles operable from the public space side and made of non-combustible or fire-restricting material.

#### 202. Structure

1. In **202. 1** of the Rules, ships which not applied the regulations of registered country, as category A crafts and ships restricted in service area (ships with service restriction notations of equipment "C" or "S"), are applied only areas of major fire hazard in requirements of **Table 7.1.1** and **Table 7.1.2**.

#### 203. Fire-resisting divisions

1. In **203.** of the Rules, ships which not applied the regulations of registered country, as category A crafts and ships restricted in service area, are applied only areas of major fire hazard.
2. In application to **203. 6** of the Rules, watertight doors of steel without fire insulation may only be accepted if there is no risk of igniting combustible materials on the other side of the fire-resisting divisions in a fire, and if fastening of the door is arranged to avoid excessive heat transfer to the bulkhead.

#### 204. Restricted use of combustible materials

1. In application to **204. 4** of the Rules, these requirements are also applied to the windows in the relevant area.
2. The requirements in **204. 7** of the Rules do not apply to ships unrestricted in service area.

#### 205. Arrangement (2022)

1. In application to **205. 1** of the Rules, open stairways may be fitted in public spaces consisting of only two decks, provided that :
  - (1) all levels are used for the same purpose;
  - (2) the area of the opening between the lower and upper parts of the space is at least 10% of the deck area between the upper and lower parts of the space;
  - (3) the design is such that persons within the space should be generally aware, or could easily be made aware of, a developing fire or other hazardous situation located within that space;
  - (4) sufficient means of escape are provided from both levels of the space directly leading to an adjacent safe area or compartment; and
  - (5) the whole space is served by one section of the sprinkler system.
2. The requirements in **205. 2** and **3** of the Rules do not apply to ships restricted in service area.

#### 207. Ventilation

1. In application to **207. 2** of the Rules, the terms "other spaces" in the wording means provided for stopping the power ventilation to the machinery space are to be separated from the means provided

---

for stopping ventilation of other spaces" means other machinery space or other space.

### 209. Openings in fire-resisting divisions

1. The requirements in 209. 2 of the Rules do not apply to ships restricted in service area.
2. Special category spaces in ships engaged on domestic sea voyage are provided with the fixed fire detection and fire alarm systems, and TV monitoring systems(if not make a round of patrol continuously).

## Section 3 Additional Requirements for High Speed Passenger Craft

### 301. Arrangement

1. The requirements in 201. 1 of the Rules do not apply to a ship not engaged on international sea voyages. ↴

## CHAPTER 2 FIRE DETECTION AND EXTINCTION

### Section 2 Fire Detection and Extinction

#### 201. Fire detection and extinguishing systems

1. The requirements in **201. 2 (1) (O) (a)** of the Rules are considered satisfied by arranging the loop such that detectors, indicating units and control panel of each section are grouped in accordance with **201. 2 (1) (D)** and **(F)** will not pass through a space, or a part of a space, covered by a detector more than once.
2. The requirements in **201. 2 (1) (O) (b)** of the Rules are considered satisfied when a fault occurring in the loop only render ineffective a part of the loop. This part of the loop is not to be larger than a section in a system which is without means of remotely identifying each detector.
3. In application to **201. 4** of the Rules, As category A passenger craft a ship not engaged on international sea voyages, this ship of less than 30 m length and distance between control station and centralized fire fighting controls of not more than 15 m may be accepted to centralize the fire fighting equipment and controls for the machinery spaces in a different location than the main control station, provided equivalent fire fighting abilities and overall safety can be documented.
4. In application to **201. 5** of the Rules, a ship not engaged on international sea voyages and used gas as the extinguishing medium are to be provided with the sufficient quantity of gas for one discharge
5. In application to **201. 6 (1) (H)** of the Rules, for gas turbines that are fitted in a dedicated enclosure of ships restricted in service area, automatic release of fire-extinguishing medium inside the enclosures are taken to avoid any risk of automatic release when persons are present in the protected space.
6. In application to **201. 8 (1)** of the Rules, a ship not engaged on international sea voyages are arranged at least one pump or more.
7. The requirements in **201. 8 (2)** of the Rules do not apply to ships of 1,000 gross tonnage and upwards restricted in service area
8. In application to **201. 8 (3)** of the Rules, for a ship not engaged on international sea voyages(except for category B passenger craft), isolating valves to separate the section of the fire main within the fire pump space from the rest of the system are not required if the fire pumps are located in areas of minor fire hazard. However valves are to be fitted to prevent the possibility that a failure in one fire pump may the whole system out of service.

#### 202. Protection of special category and ro-ro spaces

1. The requirements in **202. 2 (1)** of the Rules do not apply to a ship not engaged on international sea voyages.

#### 203. Fire control plans

1. In application to **203. 1** of the Rules, fire control plans for a ship not engaged on international sea voyages may not be included a translation of English or French language.

#### 204. Fire-fighter's outfits

1. In application to **204.** of the Rules, for a ship not engaged on international sea voyages, ships having special category spaces are to carry at least two fire-fighter's outfits and other ships are to carry at least one fire-fighter's outfits.
2. The requirements in **204. 1 (1) to (3)** of the Rules do not apply to a ship not engaged on international sea voyages.

---

### Section 3 Additional Requirements for High Speed Passenger Craft

#### 301. Fixed sprinkler system

1. The requirements in **301.** of the Rules do not apply to category A ships a ship not engaged on international sea voyages, ships of less than 1,000 gross tonnage or category B ships a ship not engaged on international sea voyages.

### Section 4 Additional Requirements for High Speed Cargo Craft

#### 401. Cargo spaces

1. The requirements in **401.** of the Rules do not apply to ships a ship not engaged on international sea voyages. ↓

---

---

**RULES AND GUIDANCE FOR THE  
CLASSIFICATION OF  
HIGH SPEED AND LIGHT CRAFTS**

Published by

**KR**

36, Myeongji ocean city 9-ro, Gangseo-gu,  
BUSAN, KOREA

TEL : +82 70 8799 7114

FAX : +82 70 8799 8999

Website : <http://www.krs.co.kr>

---

---

Copyright© 2023, **KR**

Reproduction of this Rules and Guidance in whole or in  
parts is prohibited without permission of the publisher.